



Installation, Operation, and Maintenance

Sintesis™ Air-Cooled Chillers

Model RTAF



EcoWise™

Sintesis™ chillers are part of the Trane EcoWise™ portfolio of products that are designed to lower the environmental impact with next-generation, low global warming potential (GWP) refrigerants and high efficiency operation.

⚠ SAFETY WARNING

Only qualified personnel should install and service the equipment. The installation, starting up, and servicing of heating, ventilating, and air-conditioning equipment can be hazardous and requires specific knowledge and training. Improperly installed, adjusted or altered equipment by an unqualified person could result in death or serious injury. When working on the equipment, observe all precautions in the literature and on the tags, stickers, and labels that are attached to the equipment.



Introduction

Read this manual thoroughly before operating or servicing this unit.

Warnings, Cautions, and Notices

Safety advisories appear throughout this manual as required. Your personal safety and the proper operation of this machine depend upon the strict observance of these precautions.

The three types of advisories are defined as follows:

⚠ WARNING Indicates a potentially hazardous situation which, if not avoided, could result in death or serious injury.

⚠ CAUTION Indicates a potentially hazardous situation which, if not avoided, could result in minor or moderate injury. It could also be used to alert against unsafe practices.

NOTICE Indicates a situation that could result in equipment or property-damage only accidents.

Important Environmental Concerns

Scientific research has shown that certain man-made chemicals can affect the earth's naturally occurring stratospheric ozone layer when released to the atmosphere. In particular, several of the identified chemicals that may affect the ozone layer are refrigerants that contain Chlorine, Fluorine and Carbon (CFCs) and those containing Hydrogen, Chlorine, Fluorine and Carbon (HCFCs). Not all refrigerants containing these compounds have the same potential impact to the environment. Trane advocates the responsible handling of all refrigerants-including industry replacements for CFCs and HCFCs such as saturated or unsaturated HFCs and HCFCs.

Important Responsible Refrigerant Practices

Trane believes that responsible refrigerant practices are important to the environment, our customers, and the air conditioning industry. All technicians who handle refrigerants must be certified according to local rules. For the USA, the Federal Clean Air Act (Section 608) sets forth the requirements for handling, reclaiming, recovering and recycling of certain refrigerants and the equipment that is used in these service procedures. In addition, some states or municipalities may have additional requirements that must also be adhered to for responsible management of refrigerants. Know the applicable laws and follow them.

⚠ WARNING

Proper Field Wiring and Grounding Required!

Failure to follow code could result in death or serious injury. All field wiring **MUST** be performed by qualified personnel. Improperly installed and grounded field wiring poses **FIRE** and **ELECTROCUTION** hazards. To avoid these hazards, you **MUST** follow requirements for field wiring installation and grounding as described in **NEC** and your local/state electrical codes.

⚠ WARNING

Personal Protective Equipment (PPE) Required!

Failure to wear proper PPE for the job being undertaken could result in death or serious injury. Technicians, in order to protect themselves from potential electrical, mechanical, and chemical hazards, **MUST** follow precautions in this manual and on the tags, stickers, and labels, as well as the instructions below:

- Before installing/servicing this unit, technicians **MUST** put on all PPE required for the work being undertaken (Examples; cut resistant gloves/sleeves, butyl gloves, safety glasses, hard hat/bump cap, fall protection, electrical PPE and arc flash clothing). **ALWAYS** refer to appropriate Safety Data Sheets (SDS) and OSHA guidelines for proper PPE.
- When working with or around hazardous chemicals, **ALWAYS** refer to the appropriate SDS and OSHA/GHS (Global Harmonized System of Classification and Labeling of Chemicals) guidelines for information on allowable personal exposure levels, proper respiratory protection and handling instructions.
- If there is a risk of energized electrical contact, arc, or flash, technicians **MUST** put on all PPE in accordance with OSHA, NFPA 70E, or other country-specific requirements for arc flash protection, **PRIOR** to servicing the unit. **NEVER PERFORM ANY SWITCHING, DISCONNECTING, OR VOLTAGE TESTING WITHOUT PROPER ELECTRICAL PPE AND ARC FLASH CLOTHING. ENSURE ELECTRICAL METERS AND EQUIPMENT ARE PROPERLY RATED FOR INTENDED VOLTAGE.**

⚠ WARNING**Follow EHS Policies!**

Failure to follow instructions below could result in death or serious injury.

- All Trane personnel must follow the company's Environmental, Health and Safety (EHS) policies when performing work such as hot work, electrical, fall protection, lockout/tagout, refrigerant handling, etc. Where local regulations are more stringent than these policies, those regulations supersede these policies.
- Non-Trane personnel should always follow local regulations.

⚠ WARNING**Refrigerant under High Pressure!**

Failure to follow instructions below could result in an explosion which could result in death or serious injury or equipment damage. System contains oil and refrigerant under high pressure. Recover refrigerant to relieve pressure before opening the system. See unit nameplate for refrigerant type. Do not use nonapproved refrigerants, refrigerant substitutes, or refrigerant additives.

Factory Warranty Information

Compliance with the following is required to preserve the factory warranty:

All Unit Installations

Startup **MUST** be performed by Trane, or an authorized agent of Trane, to **VALIDATE** this WARRANTY. Contractor must provide a two-week startup notification to Trane (or an agent of Trane specifically authorized to perform startup).

Copyright

This document and the information in it are the property of Trane, and may not be used or reproduced in whole or in part without written permission. Trane reserves the right to revise this publication at any time, and to make changes to its content without obligation to notify any person of such revision or change.

Trademarks

All trademarks referenced in this document are the trademarks of their respective owners.

Factory Training

Factory training is available through Trane University™ to help you learn more about the operation and maintenance

of your equipment. To learn about available training opportunities contact Trane University™.

Online: www.trane.com/traneuniversity

Phone: 855-803-3563

Email: traneuniversity@trane.com

Revision History

- Added 575V option information.
- Added Integrated Rapid Restart™ information.



Table of Contents

Nameplate Information	7	Chilled Water Piping Recommendations	31
Nameplates	7	Water Treatment	31
Outdoor Unit Nameplate	7	Units with Free-Cooling Option	31
Compressor Nameplate	7	Drainage	31
Model Number Descriptions	8	Evaporator Piping	31
Unit Model Number	8	Waterbox Configurations	31
Compressor Model Number	9	General Piping Information	32
Compressor Serial Number	9	Evaporator Piping Components	32
General Information	10	Entering Chilled Water Piping	33
Accessories and Loose Parts	10	Leaving Chilled Water Piping	33
Component Locations	10	Waterbox Drains and Vents	33
Evaporator Piping and Compressors	10	Pressure Gauges	33
Condenser Fans	11	Pressure Relief Valves	33
General Data	12	Evaporator Flow Switch	33
Free-Cooling System	14	Evaporator Waterside Pressure Drop	35
Glycol Volumes	14	Standard Unit	35
Free-Cooling Fluid Management	14	Units with Free-Cooling Option	37
Pre-Installation	15	Freeze Avoidance	45
Inspection	15	Low Evaporator Refrigerant Cutout and Glycol Requirements	46
Inspection Checklist	15	Installation Electrical	48
Storage	15	General Recommendations	48
Installation Requirements	16	Installer-Supplied Components	48
Dimensions and Weights	17	Power Supply Wiring	48
Service Clearance	17	Control Power Supply	48
Unit Dimensions	17	Programmable Relays	49
Weights	18	Relay Assignments Using	
Base Weights	18	Tracer TU	50
Option Weights	19	Low Voltage Wiring	50
Installation Mechanical	20	Emergency Stop	50
Location Requirements	20	External Auto/Stop	51
Sound Considerations	20	Ice Building Option	51
Wind Load Considerations	20	External Chilled Water Setpoint (ECWS) Option	51
Foundation	20	External Demand Limit Setpoint (EDLS) Option	52
Clearances	20	Chilled Water Reset (CWR)	52
Lifting and Moving Instructions	20	AFD Drive	53
Center of Gravity	22	AFD Drive Installation	53
Isolation and Sound Emission	23		
Unit Isolation and Leveling	23		

Communication Interfaces	55	Extended Shutdown Procedure	76
LonTalk Interface (LCI-C)	55	Seasonal Unit Start-Up Procedure	77
BACnet Interface (BCI-C)	55	System Restart After Extended Shutdown	77
Modbus Remote Terminal Unit Interface	55	Sequence of Operation	78
Operating Principles	56	Software Operation Overview	78
Refrigerant Circuit	56	Timelines	78
Refrigerant Cycle	56	Power Up Diagram	79
Refrigerant and Oil	56	Power Up to Starting	80
Compressor and Lube Oil System	56	Stopped to Starting	81
Condenser and Fans	56	Running (Lead Compr/Circuit Start - Run)	82
Evaporator	57	Running (Lag Compr/Circuit Start - Run)	83
Refrigerant Management	57	Satisfied Setpoint	84
Mechanical Cooling Mode	57	Unloading Unstaging	85
Combined Mechanical and		Normal Shutdown to Stopped or Run Inhibit	86
Free-Cooling Mode	57	Immediate Shutdown to Stopped or Run In-	87
Free-Cooling Only Mode	57	hibit	87
Controls	58	Ice Making (Running to Ice Making to Run-	88
Overview	58	ing)	88
UC800 Specifications	58	Ice Making (Auto to Ice Making to Ice Making	89
Wiring and Port Descriptions	58	Complete)	89
Communication Interfaces	59	Maintenance	90
Rotary Switches	59	Recommended Maintenance	90
LED Description and Operation	59	Weekly	90
Tracer AdaptiView TD7 Display	59	Monthly	90
Operator Interface	59	Annual	90
Home Screen	60	Refrigerant and Oil	
Viewing Operating Modes	60	Charge Management	91
Alarms	65	Lubrication System	91
Reports	65	Oil Sump Level Check	91
Equipment Settings	68	Travel Restraint	92
Display Settings	70	Microchannel Condenser Coils	92
Cleaning the Display	71	Coil Cleaning	92
Security Settings	72	Free-Cooling Option Maintenance	93
Disabling/Enabling Security	72	Free-Cooling Fluid Management	94
Tracer TU	73	Diagnostics	95
Integrated Rapid Restart	74	AFD Diagnostics	96
Pre-Start	75	Starter Diagnostics	97
Start-Up and Shutdown	76	Main Processor Diagnostics	99
Unit Start-Up	76	Communication Diagnostics	110
Temporary Shutdown And Restart	76	Wiring	116



Table of Contents

Log and Check Sheets 117



Nameplate Information

Nameplates

The Sintesis outdoor unit nameplates are applied to the exterior of the Control Panel. A compressor nameplate is located on each compressor. When the unit arrives, compare all nameplate data with ordering, submittal, and shipping information.

Outdoor Unit Nameplate

See figure below for a typical unit nameplate. The outdoor unit nameplate provides the following information:

- Unit model and size description.
- Unit serial number.
- Identifies unit electrical requirements.
- Lists correct operating charges of R-134a and refrigerant oil (Trane OIL00311).
- Lists unit test pressures.
- Identifies installation, operation and maintenance and service data literature.
- Lists drawing numbers for unit wiring diagrams.

Model Number Coding System

Model numbers are composed of numbers and letters that represent features of the equipment. Shown below is a sample of typical unit model number.

An example of a typical unit model number (M/N) is:
RTAF 130E UA0V XUA2 N21X 1NXN CVSC AXXX XPAX 1XXX X

Each position, or group of positions, in the model number is used to represent a feature. Unit model number digits are selected and assigned in accordance with the definitions as listed in Model Number Description chapter. For example, position 08 of the unit model number above contains the letter "E". An "E" in this position means that the unit voltage is 460/60/3.

Compressor Nameplate

The compressor nameplate provides the following information:

- Compressor model number. See Model Number Description chapter.
- Compressor serial number. See Model Number Description chapter.
- Compressor electrical characteristics.
- Utilization range.
- Recommended refrigerant.

Figure 1. Typical unit nameplate



Model Number Descriptions

Unit Model Number

Digits 1, 2 – Unit Model

RT = Rotary Chiller

Digit 3 – Unit Type

A = Air-cooled

Digit 4 – Development Sequence

F = Development Sequence

Digits 5-7 – Nominal Capacity

115 = 115 Nominal Tons
130 = 130 Nominal Tons
150 = 150 Nominal Tons
170 = 170 Nominal Tons
180 = 180 Nominal Tons
200 = 200 Nominal Tons
215 = 215 Nominal Tons
230 = 230 Nominal Tons
250 = 250 Nominal Tons
270 = 270 Nominal Tons
280 = 280 Nominal Tons
310 = 310 Nominal Tons
350 = 350 Nominal Tons
390 = 390 Nominal Tons
410 = 410 Nominal Tons
450 = 450 Nominal Tons
500 = 500 Nominal Tons
520 = 520 Nominal Tons

Digit 8 – Voltage Selection

C = 380/60/3
D = 400/50/3
E = 460/60/3
F = 575/60/3

Digit 9 – Manufacturing Location

U = Trane Commercial Systems, Pueblo, CO USA

Digits 10, 11 – Design Sequence

** = Factory assigned

Digit 12 – Unit Efficiency

H = High Efficiency
N = Standard Efficiency

Digit 13 – Unit Sound Package

X = Standard Noise

Digit 14 – Agency Listing

U = UL/cUL Listing

Digit 15 – Pressure Vessel Code

A = ASME Pressure Vessel Code
C = CRN or Canadian Equivalent Pressure Vessel Code
D = Australia Pressure Vessel Code

Digit 16 – Factory Charge

1 = Refrigerant Charge R-513A
2 = Refrigerant Charge R-134a
3 = Nitrogen Charge (R-513A Field Supplied)
4 = Nitrogen Charge (R-134a Field Supplied)

Digit 17 – Evaporator Application

N = Standard Cooling (above 40°F/5.5°C)
P = Low Temp Process Cooling (below 40°F/5.5°C)
C = Ice Making

Digit 18 – Evaporator Configuration

1 = 1-pass Evaporator
2 = 2-pass Evaporator
R = 1-pass Evaporator with Turbulators
T = 2-pass Evaporator with Turbulators

Digit 19 – Evaporator Fluid Type

1 = Water
2 = Calcium Chloride
3 = Ethylene Glycol
4 = Propylene Glycol
5 = Methanol

Digit 20 – Water Connection

X = Grooved Pipe Connection
W = Grooved Pipe + Flange

Digit 21 – Flow Switch

1 = Factory Installed - Other Fluid (15 cm/s)
2 = Factory Installed - Water (35 cm/s)
3 = Factory Installed - Water (45 cm/s)

Digit 22 – Insulation

N = Factory Insulation All Cold Parts 0.75"
H = Evaporator-only Insulation for High Humidity/Low Evap Temp

Note: Digit 22 selection H is special order only.

Digit 23 – Unit Application

X = Standard Ambient (14 to 115°F/-10 to 46°C)
L = Low Ambient (-4 to 115°F/-20 to 46°C)
H = High Ambient (14 to 130°F/-10 to 54.4°C)
W = Wide Ambient (-4 to 130°F/-20 to 54.4°C)

Digit 24 – Condenser Fin Options

N = Aluminum Microchannel
C = CompleteCoat™ Microchannel

Digit 25 – Fan Type

C = Variable Speed Fans

Digit 26 – Auxiliary Items

C = Oil Cooler

Digit 27 – Compressor Starter

V = Adaptive Frequency™ Drive

Digit 28 – Incoming Power Line Connection

1 = Single Point Unit Power Connection
2 = Dual Point Unit Power Connection

Digit 29 – Power Line Connection Type

Units with model number digit 28 = 2 OR Units with 2 compressors and model number digit 28 = 1:

X = Terminal Block
C = Circuit Breaker
H = Circuit Breaker with High Fault Rated Control Panel

Unit with 3 or 4 compressors and model number digit 28 = 1:

X = Terminal Block with Individual System Circuit Breaker
C = Circuit Breaker with Individual System Circuit Breaker
H = High Fault Circuit Breaker with Individual System Circuit Breaker in High Fault Rated Control Panel

Digit 30 – Short Circuit Current Rating

A = Default Short Circuit Rating
B = High Fault Short Circuit Rating

Digit 31 – Electrical Accessories

X = No Convenience Outlet
P = 15A 115V Convenience Outlet

Digit 32 – Remote Communication Option

X = None
B = BACnet® Interface
M = Modbus™ Interface
L = LonTalk® Interface

Digit 33 – Hard Wire Communication

X = None
A = Hard Wired Bundle - All
B = Remote Leaving Water Temp Setpoint
C = Remote Leaving Temp and Demand Limit Setpoints
D = Programmable Relay
E = Programmable Relay and Leaving Water and Demand Limit Setpoint
F = Percent Capacity
G = Percent Capacity and Leaving Water and Demand Limit Setpoint
H = Percent Capacity and Programmable Relay

Digit 34 – Energy Meter

X = None

Model Number Descriptions

Digit 35 — Smart Flow Control

X = None

Digit 36 — Structural Options

A = Standard Unit Structure

D = Wind Load for Florida Hurricane

Digit 37 — Appearance Options

X = No Appearance Options

A = Architectural Louvered Panels

Digit 38 — Unit Isolation

X = None

1 = Elastomeric Isolators

Digit 39 — Shipping Package

X = No Shipping Package

A = Containerization Package

T = Shipped with Tarp Covering Full Unit

Digits 40, 41

XX = Reserved for future use

Digit 42 — Free-Cooling

X = None

F = Total Free-Cooling — Glycol

Digit 43 — Special Requirement

0 = None

F = Ship to Final Finisher

S = Special Requirement

Compressor Model Number

Digits 1-3 — Compressor Family

CHH= Positive displacement, refrigerant, helical rotary, hermetic compressor

Digit 4 — Compressor Type

T = GP2+

W = GP2.5

Digit 5 — Economizer Port Detail

0 = No Economizer Port

A = Economizer Port = 65°, Vi = 3.5

E = Economizer Port = 140°, Vi = 3.57

Digit 6 — Frame Size

L = L Frame

M = M Frame

N = N Frame

Digit 7 — Compressor Capacity

3 = GP2+ Smaller capacity (minor)

4 = GP2+ Larger capacity (major)

5 = GP2.5 Smaller capacity (minor)

6 = GP2.5 Larger capacity (major)

Digit 8 — Motor Voltage

D = 380-60-3

H = 575-60-3

T = 400/460-50/60-3
used for 380-50-3

K = 460-60-3 (N6 only)

Digit 9 — Internal Relief

K = 450 psid

Digits 10-11 — Design Sequence

** = Factory assigned

Digit 12 — Capacity Limit

N = Standard capacity

Digits 13-15 — Motor kW Rating

048 = L1 50Hz

057 = L1 60Hz

058 = L2 50Hz

069 = L2 60Hz

065 = M3 50Hz

077 = M3 60Hz

077 = M4 50Hz

092 = M4 60Hz

093 = N3/N5 50Hz

112 = N3/N5 60Hz

112 = N6 50Hz

134 = N6 60Hz

Digit 16 — Volume Ratio

A = High Volume Ratio

Compressor Serial Number

Digits 1-2 — Year

YY = Last two digits of year of manufacture

Digits 3-4 — Week

WW= Week of build, from 00 to 52

Digit 5 — Day

1 = Monday

2 = Tuesday

3 = Wednesday

4 = Thursday

5 = Friday

6 = Saturday

7 = Sunday

Digits 6-8 — Coded Time Stamp

TTT= Used to ensure uniqueness of serial number

Digit 9 — Assembly Line

L = Varies with facility

Digit 10 — Build Location

A = Monterrey



General Information

The Sintesis RTAF units are helical-rotary type, air-cooled chillers designed for outdoor installation. The refrigerant circuits are factory-piped, leak tested and dehydrated. Every unit is electrically tested for proper control operation before shipment.

Chilled water inlet and outlet openings are covered for shipment. The Sintesis RTAF features Trane's exclusive Adaptive Control™ logic, which monitors the control variables that govern the operation of the chiller unit. Adaptive control logic can adjust capacity variables to avoid chiller shutdown when necessary, and keep producing chilled water. The units feature two independent refrigerant circuits. Each circuit utilizes at least one compressor driven by an Adaptive Frequency Drive. Each refrigerant circuit is provided with filter, sight glass, electronic expansion valve, and charging valves. The shell-and-tube CHIL™ (Compact-High performance-Integrated design-Low charge) evaporator is manufactured in accordance with the ASME standards or other international codes. Each evaporator is fully insulated and equipped with water drain and vent connection.

Units are shipped with full oil charge and can be ordered with either a factory refrigerant charge or optional nitrogen charge.

Accessories and Loose Parts

Check all the accessories and loose parts that are shipped with the unit against the shipping list. Included in these items will be the water vessel drain plugs, rigging and electrical diagrams, service literature, which are placed inside the control panel and/or starter panel for shipment.

If optional elastomeric isolators are ordered with the unit (model number digit 37=1) they are shipped mounted on the horizontal support frame of the chiller.

Component Locations

Evaporator Piping and Compressors

See figure below for evaporator orientation and water flow orientation. See unit submittal for water connection location dimensions.

Figure below also shows the location of compressors for the various unit configurations.

Important: On 3- and 4-compressor units, location of compressor 2A varies with unit size. See unit labels to verify component designation.

Figure 2. Evaporator piping and compressor locations

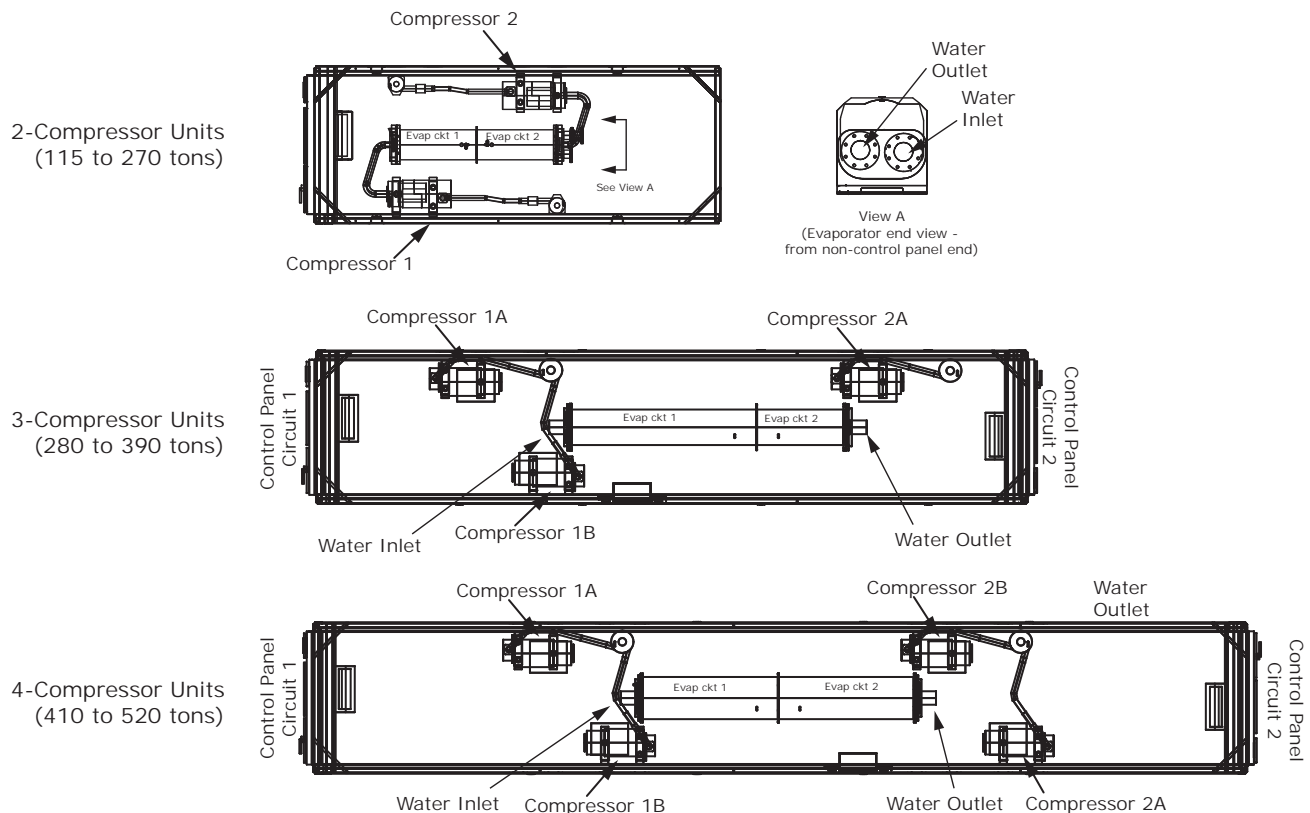

Condenser Fans

The location of the circuit 1 and circuit 2 fan banks varies by unit size. See figure below for locations.

Note: Circuit 2 fans are shaded. For more information, see unit component location drawings in Wiring Manual RTAF-SVE001*-EN.

Figure 3. Condenser fan locations

115T, 130T

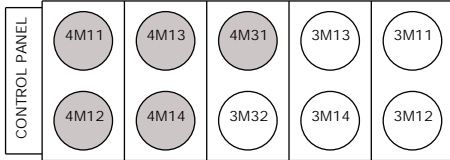

150T, 170T, 180T

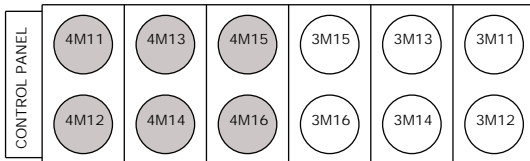

200T, 215T, 230T, 250T, 270T

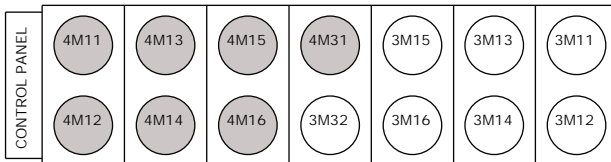

280T



310T, 350T, 390T

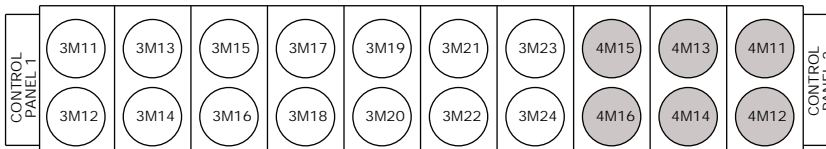

410T

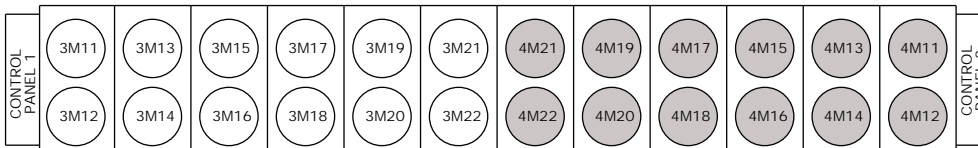

450T, 500T, 520T

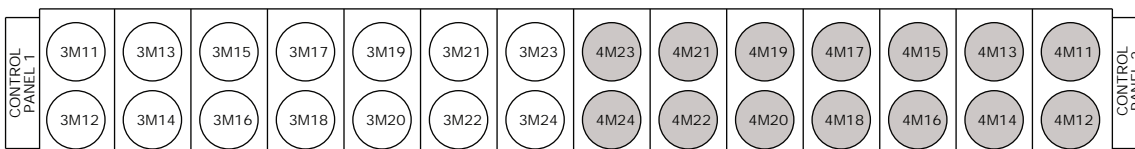



General Information

General Data

Table 1. General data table – 115 to 215 ton units

Unit Size (tons)		115	130	150	170	180	200	215
Compressor Model (ckt1/ckt 2) ^(a)		55/55	65/65	70/70	85/70	85/85	100/85	100/100
Quantity	#	2	2	2	2	2	2	2
Evaporator								
Water Connection Size	in	4	4	5	5	5	6	6
Passes	#	2	2	2	2	2	2	2
Water Storage	gal	14.0	15.8	19.3	20.6	21.6	21.9	23.9
	L	53.1	59.9	73.2	78.0	81.9	82.8	90.5
Minimum Flow ^(b)	gpm	128	150	171	187	199	202	228
	L/s	8.1	9.5	10.8	11.8	12.6	12.8	14.4
Maximum Flow ^(b)	gpm	470	551	626	684	731	742	835
	L/s	29.7	34.8	39.5	43.2	46.1	46.8	52.7
Condenser								
Qty of Coils (ckt 1/ckt 2)		5/5	5/5	6/6	6/6	6/6	7/7	7/7
Coil Length	in	77.4	77.4	77.4	77.4	77.4	77.4	77.4
	mm	1967	1967	1967	1967	1967	1967	1967
Coil Height	in	47.8	47.8	47.8	47.8	47.8	47.8	47.8
	mm	1214	1214	1214	1214	1214	1214	1214
Free-Cooling Coils								
Qty of Coils (ckt 1/ckt 2)		5/4	5/4	6/5	6/5	6/5	7/6	7/6
Coil Length	in	75.8	75.8	75.8	75.8	75.8	75.8	75.8
	mm	1925	1925	1925	1925	1925	1925	1925
Coil Height	in	37.0	37.0	37.0	37.0	37.0	37.0	37.0
	mm	941	941	941	941	941	941	941
Condenser Fans								
Quantity (ckt 1/ckt 2)	#	5/5	5/5	6/6	6/6	6/6	7/7	7/7
Diameter	in	31.5	31.5	31.5	31.5	31.5	31.5	31.5
	mm	800	800	800	800	800	800	800
Nominal speed	rpm	810	810	810	810	810	909	909
Airflow	cfm	9760	9760	9760	9760	9760	11,000	11,000
Airflow with Free-Cooling Coil	cfm	8338	8338	8338	8338	8338	9567	9567
	m ³ /s	4.6	4.6	4.6	4.6	4.6	5.2	5.2
Tip Speed	ft/min	6673	6673	6673	6673	6673	7500	7500
	m/s	33.9	33.9	33.9	33.9	33.9	38.1	38.1
Ambient Temperature Range								
Standard Ambient	°F (°C)	14 to 115 (-10 to 46)						
Low Ambient	°F (°C)	-4 to 115 (-20 to 46)						
High Ambient	°F (°C)	14 to 130 (-10 to 54.4)						
Wide Ambient	°F (°C)	-4 to 130 (-20 to 54.4)						
General Unit								
Refrigerant		R-134a or R-513A						
Refrigerant Ckts	#	2	2	2	2	2	2	2
Minimum Load	%	15	15	15	15	15	15	15
Refrigerant Charge (ckt 1/ckt 2)	lb	86.4/ 84.9	86.6/ 84.9	101.4/ 99.0	111.1/ 99.0	109.0/ 96.3	134.3/129.4	134.7/129.8
	kg	39.2/38.5	39.3/38.5	46.0/44.9	50.4/44.9	49.5/43.7	60.9/58.7	61.1/59.0
Oil		Trane OIL00315 (1 gal)/OIL00317 (5 gal)						
Oil Charge/ckt	gal	1.53	1.56	1.56	1.56	1.64	1.96	2.01
	L	5.8	5.9	5.9	5.9	6.2	7.4	7.6

(a) Nominal tonnage at 60 Hz.

(b) Minimum and maximum flow rates apply to constant-flow chilled water system running at AHRI conditions, without freeze inhibitors added to the water loop.

Table 2. General data – 230 to 520 ton units

Unit Size (tons)		230	250/270	280	310	350/390	410	450	500/520
Compressor Model (ckt 1/ckt 2)^(a)		120/100	120/120	100-100/70	100-100/100	100-120/120	100-100/100-100	100-120/100-120	120-120/120-120
Quantity	#	2	2	3	3	3	4	4	4
Evaporator									
Water Connection Size	in	6	6	8	8	8	8	8	8
Passes	#	2	2	1	1	1	1	1	1
Water Storage	gal	28.5	30.6	31.2	32.6	35.8	41.8	44.8	46.1
	L	107.7	115.9	118.1	123.3	135.4	158.1	169.5	174.7
Minimum Flow ^(b)	gpm	261	288	304	323	367	446	487	506
	L/s	16.5	18.2	19.2	20.4	23.1	28.1	30.7	31.9
Maximum Flow ^(b)	gpm	957	1055	1113	1183	1345	1635	1786	1855
	L/s	60.4	66.6	70.2	74.6	84.9	103.2	112.7	117.1
Condenser									
Qty of Coils (ckt 1/ckt 2)		7/7	7/7	12/6	14/6	14/6	12/12	14/14	14/14
Coil Length	in	77.4	77.4	77.4	77.4	77.4	77.4	77.4	77.4
	mm	1967	1967	1967	1967	1967	1967	1967	1967
Coil Height	in	47.8	47.8	47.8	47.8	47.8	47.8	47.8	47.8
	mm	1214	1214	1214	1214	1214	1214	1214	1214
Free-Cooling Coils^(c)									
Qty of Coils (ckt 1/ckt 2)		7/6	7/6	11/5	13/5	13/5	11/11	13/13	13/13
Coil Length	in	75.8	75.8	75.8	75.8	75.8	75.8	75.8	75.8
	mm	1925	1925	1925	1925	1925	1925	1925	1925
Coil Height	in	37.0	37.0	37.0	37.0	37.0	37.0	37.0	37.0
	mm	941	941	941	941	941	941	941	941
Condenser Fans									
Quantity (ckt 1/ckt 2)	#	7/7	7/7	12/6	14/6	14/6	12/12	14/14	14/14
Diameter	in	31.5	31.5	31.5	31.5	31.5	31.5	31.5	31.5
	mm	800	800	800	800	800	800	800	800
Nominal Speed	rpm	909	909	909	909	909	909	909	909
Airflow	cfm	11,000	11,000	11,000	11,000	11,000	11,000	11,000	11,000
Airflow w/ Free-Cooling Coil ^(c)	cfm	9567	9567	9567	9567	9567	9567	9567	9567
	m ³ /sec	5.2	5.2	5.2	5.2	5.2	5.2	5.2	5.2
Tip Speed	ft/min	7500	7500	7500	7500	7500	7500	7500	7500
	m/s	38.1	38.1	38.1	38.1	38.1	38.1	38.1	38.1
Ambient Temperature Range									
Standard Ambient	°F (°C)	14 to 115 (-10 to 46)							
Low Ambient	°F (°C)	-4 to 115 (-20 to 46)							
High Ambient ^(c)	°F (°C)	14 to 130 (-10 to 54.4)							
Wide Ambient ^(c)	°F (°C)	-4 to 130 (-20 to 54.4)							
General Unit									
Refrigerant		R-134a or R-513A ^(d)							
Refrigerant Ckts	#	2	2	2	2	2	2	2	2
Minimum Load	%	15	15	15	15	15	15	15	15
Refrigerant Charge (ckt 1/ckt 2)	lb	155.4/154.8	155.4/154.8	263.1/118.4	272.5/120.0	276.0/121.2	253.0/259.7	266.9/278.8	275.1/287.8
	kg	70.7/70.4	70.7/70.4	119.6/53.8	123.8/54.5	125.4/55.1	115.0/118.0	121.3/126.7	125.0/130.8
Oil		Trane OIL00315 (1 gal)/OIL00317 (5 gal)							
Oil Charge (ckt 1/ckt 2)	gal	2.35/2.35	2.35/2.35	4.24/2.17	4.26/2.17	4.27/2.17	4.26/4.29	4.30/4.33	4.33/4.37
	L	8.9/8.9	8.9/8.9	16.1/8.2	16.1/8.2	16.2/8.2	16.1/16.2	16.3/16.4	16.4/16.5

(a) Nominal tonnage at 60 Hz. Where there are 2 compressors on a circuit, they are indicated 1A-1B/2A-2B.

(b) Minimum and maximum flow rates apply to constant-flow chilled water system running at AHRI conditions, without freeze inhibitors added to the water loop.

(c) Not available for 270, 390 and 520 ton units. Free cooling is not available for 230, 250, 350 and 500 ton 575V units. High and wide ambient are not available for all 575V units.

(d) R-513A is not available on 270, 290 and 520 tons units.



General Information

Free-Cooling System

Glycol Volumes

Note: Volumes listed in table below are in addition to the fluid volume for standard unit configuration.

Table 3. Free-cooling system glycol volume

Unit Size	Total Glycol Volume	
	gal	L
115	59.25	224.27
130	59.25	224.27
150	75.36	285.26
170	75.36	285.26
180	75.36	285.26
200	89.97	340.59
215	89.97	340.59
230	89.97	340.59
250	89.97	340.59
280	201.53	762.89
310	211.97	802.38
350	211.97	802.38
410	247.12	935.44
450	282.27	1068.50
500	282.27	1068.50

Free-Cooling Fluid Management

NOTICE:

Equipment Damage!

Failure to follow instructions below could cause equipment damage.

DO NOT USE UNTREATED WATER. Glycol solution must be utilized with the Direct Free Cooling option. Glycol percentage should be based on freeze avoidance requirements. The glycol solution requires an inhibitor package to be carefully chosen with the aid of a qualified water treatment specialist to abate corrosion in a mixed metal system.

The building glycol loop should not be vented to atmosphere. A closed system is required to limit oxidation potential within the loop.

Make-up water should be avoided.

The direct free cooling option circuit consists of copper, carbon steel, cast iron, zinc, EPDM rubber, brass, and Aluminum AA3102, AA3003, AA4045 in addition to other materials that may be in the building loop connected to the chiller. The inhibited glycol solution should be selected at desired concentration to insure adequate inhibitor content. It is not advised to dilute a stronger concentrate due to inhibitor dilution. Glycol fluid should be free from foreign solid particles. A maintenance schedule should be selected per the glycol manufacturer's requirements to insure adequate protection during product usage.



Pre-Installation

Inspection

When the unit is delivered, verify that it is the correct unit and that it is properly equipped.

Inspect all exterior components for visible damage. Report any apparent damage or material shortage to the carrier and make a "unit damage" notation on the carrier's delivery receipt. Specify the extent and type of damage found and notify the appropriate Trane Sales Office.

Do not proceed with installation of a damaged unit without sales office approval.

Inspection Checklist

To protect against loss due to damage incurred in transit, complete the following checklist upon receipt of the unit.

- Inspect the individual pieces of the shipment before accepting the unit. Check for obvious damage to the unit or packing material.
- Inspect the unit for concealed damage as soon as possible after delivery and before it is stored. Concealed damage must be reported within 10 days after receipt.
- If concealed damage is discovered, stop unpacking the shipment. Do not remove damaged material from the receiving location. Take photos of the damage, if possible. The owner must provide reasonable evidence that the damage did not occur after delivery.
- Notify the carrier's terminal of the damage immediately, by phone and by mail. Request an immediate, joint inspection of the damage with the carrier and the consignee.
- Notify the Trane sales representative and arrange for repair. Do not repair the unit, however, until damage is inspected by the transportation representative.

Storage

Extended storage of the unit prior to the installation requires the following precautions:

Store the unit in a secured area, to avoid intentional damages.

Close the suction, discharge and liquid-line isolation valves.

At least every three months (quarterly), check the pressure in the refrigerant circuits to verify that the refrigerant charge is intact. If it is not, contact a qualified service organization and the appropriate Trane sales office.

Note: *If the unit is stored before servicing near a construction site it is highly recommended to protect micro-channel coils from any concrete dust. Failure to do so may considerably reduce reliability of the unit.*



Installation Requirements

A list of the contractor responsibilities typically associated with the unit installation process is provided in table below.

Table 4. Installation requirements

Type	Trane Supplied Trane Installed	Trane Supplied Field Installed	Field Supplied Field Installed
Foundation			<ul style="list-style-type: none"> • Meet foundation requirements
Rigging			<ul style="list-style-type: none"> • Safety chains • Clevis connectors • Lifting beam • Spreader bar
Isolation		<ul style="list-style-type: none"> • Elastomeric isolators (optional) 	<ul style="list-style-type: none"> • Elastomeric isolators (optional)
Electrical	<ul style="list-style-type: none"> • Circuit breakers (optional) • Unit mounted starter 		<ul style="list-style-type: none"> • Circuit breakers (optional) • Electrical connections to unit mounted starter • Wiring sizes per submittal and NEC • Terminal lugs • Ground connection(s) • BAS wiring (optional) • Control voltage wiring • Chilled water pump contactor and wiring • Option relays and wiring
Water piping	<ul style="list-style-type: none"> • Flow switch 		<ul style="list-style-type: none"> • Taps for thermometers and gauges • Thermometers • Water flow pressure gauges • Isolation and balancing valves in water piping • Vents and drain • Waterside pressure relief valves • Water strainer
Insulation	<ul style="list-style-type: none"> • Insulation 		<ul style="list-style-type: none"> • Insulation
Water Piping Connection Components	<ul style="list-style-type: none"> • Grooved pipe 	<ul style="list-style-type: none"> • Flange kit (optional) 	
Other Materials	<ul style="list-style-type: none"> • R-134a or R-513A refrigerant • Dry nitrogen (optional) 		
"Sintesis Model RTAF Installation Completion Check Sheet and Request for Trane Service" (RTAF-ADF001*-EN, see "Log and Check Sheets," p. 117)			
Chiller Start-up Commissioning ^(a)	<ul style="list-style-type: none"> • Trane, or an agent of Trane specifically authorized to perform start-up of Trane® products 		

(a) Start-up must be performed by Trane or an agent of Trane specifically authorized to perform start-up and warranty of Trane® products. Contractor shall provide Trane (or an agent of Trane specifically authorized to perform start-up) with notice of the scheduled start-up at least two weeks prior to the scheduled start-up.



Dimensions and Weights

Service Clearance

Figure 4. RTAF service clearances

NO OBSTRUCTIONS ABOVE UNIT

Unit sizes 115 to 270 tons:

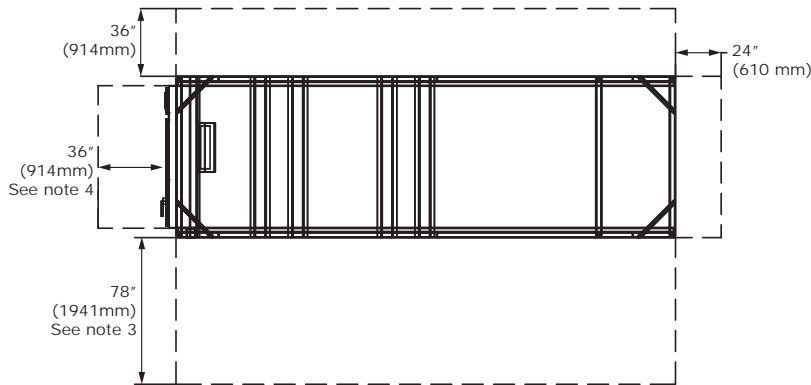

Unit sizes 280 to 520 tons:

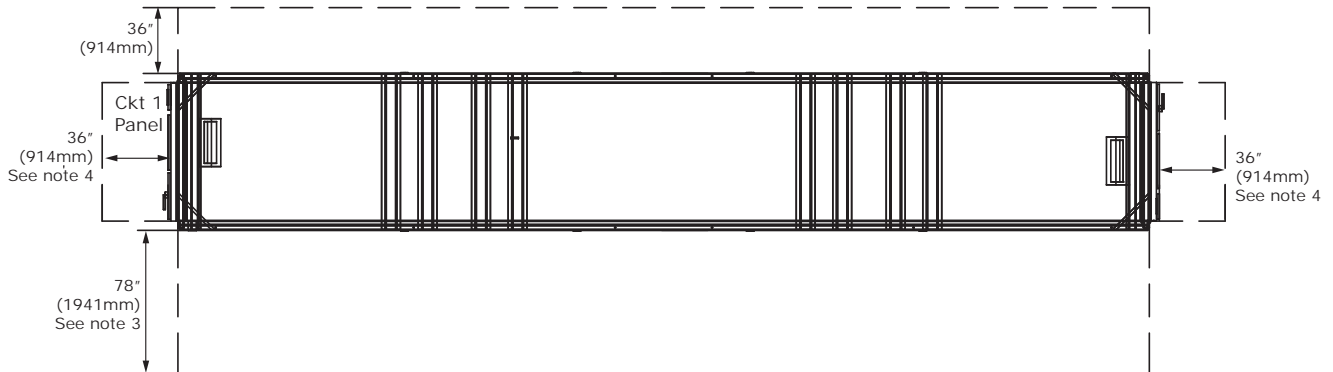

Notes:

1. Area above unit required for operation, maintenance, panel access and airflow.
NO OBSTRUCTIONS ABOVE UNIT
2. For installations with obstructions or multiple units, see Close Spacing and Restricted Airflow Bulletin RLC-PRB037*-EN.
3. Clearance of 78" (1981 mm) on the side of the unit is required for coil replacement. If sufficient clearance is not available on this side of the unit, coil replacement should be performed through top of unit.
4. A full 36" (914 mm) clearance is required in front of the control panels. Must be measured from front of panel, not end of unit base.
5. Clearances shown are sufficient for tube pull.

Unit Dimensions

See unit submittals for specific unit dimensions and water connection locations.



Dimensions and Weights

Weights

Base Weights

Note: See Option Weights table for additional weight added by optional features.

Table 5. Weights – base units (without free-cooling, model number digit 42 = X)

Unit Size (tons)	All units (except 575V) ^(a)				575V Units ^(b)			
	Shipping Weight		Operating Weight		Shipping Weight		Operating Weight	
	lb	kg	lb	kg	lb	kg	lb	kg
115	7974	3617	8091	3670	8369	3796	8486	3849
130	8071	3661	8203	3721	8466	3840	8598	3900
150	9467	4294	9628	4367	9830	4459	9989	4531
170	9497	4308	9669	4386	9861	4473	10031	4550
180	9821	4455	10002	4537	10185	4620	10364	4701
200	10829	4912	11012	4995	11224	5091	11407	5174
215	11155	5060	11355	5151	11550	5239	11751	5330
230	12549	5692	12829	5819	12963	5880	13071	5929
250	12962	5880	13242	6007	12963	5880	13080	5933
270	12962	5880	13242	6007	n/a			
280	16705	7578	16838	7638	17225	7813	17344	7867
310	17228	7815	17367	7878	18457	8372	18581	8428
350	18177	8245	18375	8335	18988	8613	19125	8675
390	18177	8245	18375	8335	n/a			
410	21199	9616	21411	9712	22736	10313	22895	10385
450	23569	10691	23794	10793	24403	11069	24575	11147
500	23669	10736	23907	10844	25232	11445	25406	11524
520	23669	10736	23907	10844	n/a			

(a) Model number digit 8 = C, D, or E.

(b) Model number digit 8 = F.

Table 6. Weights – base units (with free-cooling, model number digit 42 = F)

Unit Size (tons)	All units (except 575V) ^(a)				575V Units ^(b)			
	Shipping Weight		Operating Weight		Shipping Weight		Operating Weight	
	lb	kg	lb	kg	lb	kg	lb	kg
115	9284	4211	9893	4487	9645	4375	10256	4652
130	9381	4255	10005	4538	9742	4419	10368	4703
150	11074	5023	11861	5380	11435	5187	12222	5544
170	11105	5037	11902	5399	11466	5201	12264	5563
180	11429	5184	12235	5550	11790	5348	12597	5714
200	12713	5767	13642	6188	13109	5946	14039	6368
215	13039	5915	13986	6344	13435	6094	14381	6523
230	14457	6558	15483	7023	n/a			
250	14870	6745	15897	7211	n/a			
270	n/a				n/a			
280	19509	8849	21313	9668	20027	9084	21819	9897
310	20294	9205	22192	10066	21519	9761	23404	10616

Table 6. Weights — base units (with free-cooling, model number digit 42 = F) (continued)

Unit Size (tons)	All units (except 575V) ^(a)				575V Units ^(b)			
	Shipping Weight		Operating Weight		Shipping Weight		Operating Weight	
	lb	kg	lb	kg	lb	kg	lb	kg
350	21243	9636	23201	10524	n/a			
390	n/a				n/a			
410	24496	11111	26758	12137	26032	11808	28241	12810
450	27283	12375	29850	13540	28116	12753	30629	13893
500	27382	12420	29963	13591	n/a			
520	n/a				n/a			

(a) Model number digit 8 = C, D, or E.

(b) Model number digit 8 = F.

Option Weights

Note: Weights below for each listed option are in addition to base weights shown in table above.

Table 7. Weights — options

Unit Size (tons)	Windload Option ^(a)		Louver Option ^(b)		Single Point Power Option ^(c)	
	lb	kg	lb	kg	lb	kg
115	394	179	428	194	-	-
130	394	179	428	194	-	-
150	394	179	489	222	-	-
170	410	186	489	222	-	-
180	410	186	489	222	-	-
200	410	186	550	249	-	-
215	426	193	550	249	-	-
230	426	193	550	249	-	-
250	426	193	550	249	-	-
270	426	193	550	249	-	-
280	426	193	600	272	461	209
310	459	208	661	300	489	222
350	459	208	661	300	542	246
390	459	208	661	300	542	246
410	491	223	783	355	738	335
450	524	238	905	410	860	390
500	524	238	905	410	813	369
520	524	238	905	410	813	369

(a) Model number digit 36 = D.

(b) Model number digit 37 = A.

(c) Model number digit 28 = 1.



Installation Mechanical

Location Requirements

Sound Considerations

- Locate the unit away from sound-sensitive areas.
- Install the optional elastomeric isolators under the unit. See "Isolation and Sound Emission," p. 23.
- Chilled water piping should not be supported by chiller frame.
- Install rubber vibration isolators in all water piping.
- Use flexible electrical conduit.
- Seal all wall penetrations.

Note: Consult an acoustical engineer for critical applications.

Wind Load Considerations

For units with wind load certification and architectural louvered panels (model number digits 36 and 37 = DA), refer to Technical Evaluation Report TER-15-2904F for necessary storm preparation.

Foundation

Provide rigid, non-warping mounting pads or a concrete foundation of sufficient strength and mass to support the applicable operating weight (i.e., including completed piping, and full operating charges of refrigerant, oil and water). See "Weights," p. 18 for unit operating weights. Once in place, the unit must be level within 1/2 in (12.7mm) across the length and width of the unit. The Trane Company is not responsible for equipment problems resulting from an improperly designed or constructed foundation.

Clearances

Provide enough space around the unit to allow the installation and maintenance personnel unrestricted access to all service points. See submittal drawings for the unit dimensions, to provide sufficient clearance for the opening of control panel doors and unit service. See Figure 4, p. 17 for minimum clearances. In all cases, local codes which require additional clearances will take precedence over these recommendations.

For close spacing information, see RLC-PRB037*-EN.

Lifting and Moving Instructions

⚠ WARNING

Heavy Objects!

Failure to follow instructions below or properly lift unit could result in unit dropping and possibly crushing operator/technician which could result in death or serious injury, and equipment or property-only damage. Ensure that all the lifting equipment used is properly rated for the weight of the unit being lifted. Each of the cables (chains or slings), hooks, and shackles used to lift the unit must be capable of supporting the entire weight of the unit. Lifting cables (chains or slings) may not be of the same length. Adjust as necessary for even unit lift.

⚠ WARNING

Improper Unit Lift!

Failure to properly lift unit could result in unit dropping and possibly crushing operator/technician which could result in death or serious injury, and equipment or property-only damage. Test lift unit approximately 24 inches to verify proper center of gravity lift point. To avoid dropping of unit, reposition lifting point if unit is not level.

⚠ WARNING

Proper Lifting Configuration Required!

Use only locations designated with Lift label shown in Figure 5. Do NOT use locations marked with DO NOT LIFT label shown in Figure 5. Use unit lifting configuration as shown in Figure 6, p. 21. Other lifting arrangements could result in death, serious injury or equipment damage.

NOTICE:

Equipment Damage!

To prevent damage to unit, do not fork lift or allow lifting cables to contact unit during lift.

Figure 5. Labels – lift/do not lift location



Figure 6. Lifting configuration — 4 point

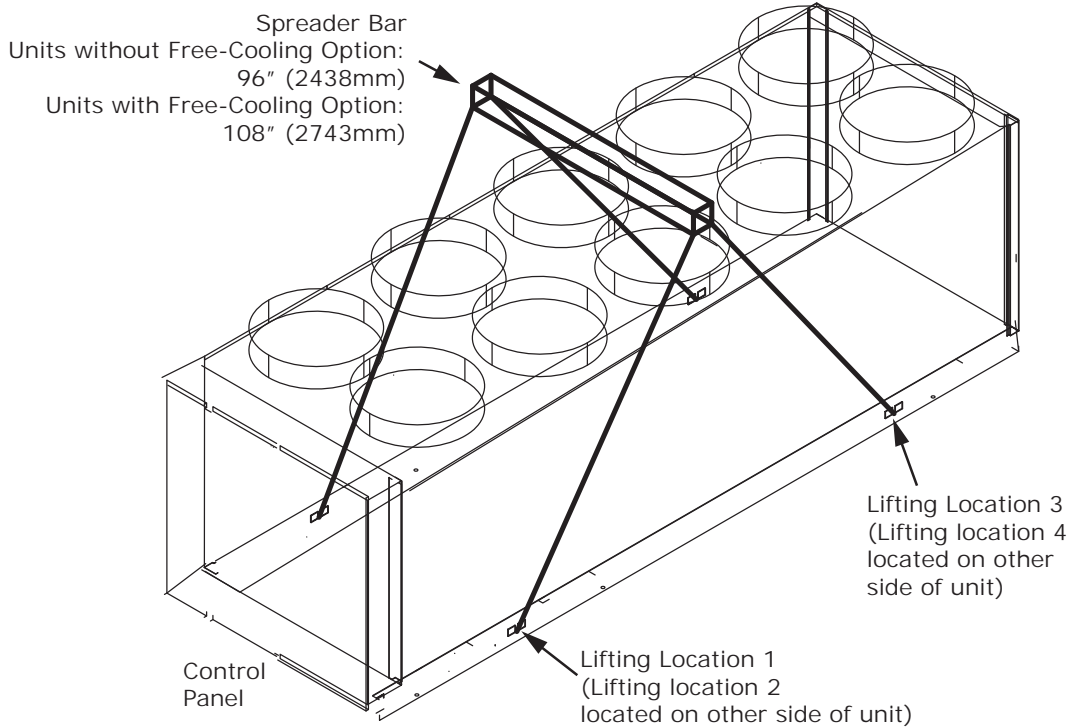
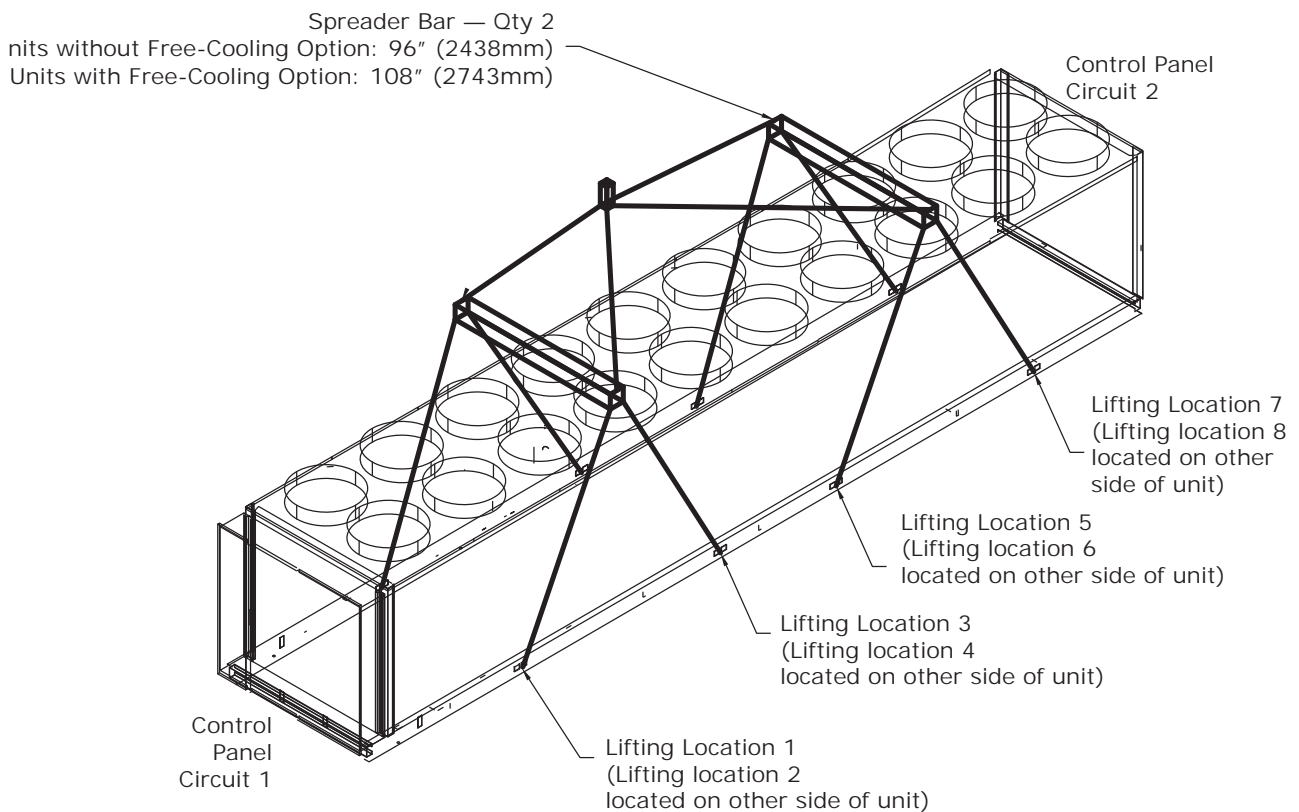

Figure 7. Lifting configuration — 8 point



Center of Gravity

Figure 8. Center of gravity

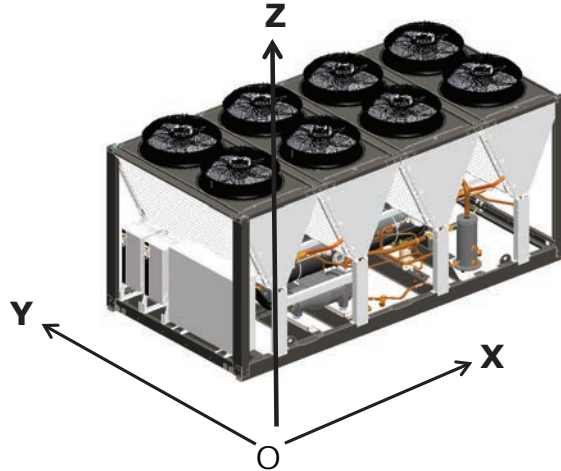

Table 8. Centers of gravity, units without free-cooling

Unit Size (tons)	All units (except 575V) ^(a)						575V Units ^(b)					
	CGx		CGy		CGz		CGx		CGy		CGz	
	in	mm	in	mm	in	mm	in	mm	in	mm	in	mm
115	93.1	2365	43.8	1112	37	939	97.3	2471	42.8	1087	36.2	920
130	93.1	2366	43.8	1112	36.7	933	97.3	2471	42.8	1087	36.0	915
150	104.1	2645	43.7	1109	36.8	936	108.7	2761	42.8	1088	36.3	922
170	104.1	2643	43.7	1109	36.8	934	108.6	2759	42.8	1088	36.3	921
180	104.7	2658	44.4	1129	36.2	920	109.1	2770	43.6	1107	35.7	907
200	113.1	2872	42.9	1090	37	939	118.7	3015	42.2	1072	36.4	925
215	113.3	2878	43.6	1107	36.5	926	118.7	3016	42.9	1089	35.9	912
230	118.3	3004	43.2	1099	34.6	880	118.7	3015	42.7	1084	34.2	869
250	121.1	3076	43.2	1099	34.6	880	121.5	3085	42.7	1084	34.2	869
270	121.1	3076	43.2	1099	34.6	880	n/a					
280	194	4928	44.4	1129	35.9	912	195.8	4974	42.9	1089	35.1	892
310	225.3	5722	44.1	1121	36.5	927	224.4	5699	42.7	1084	35.9	911
350	229.2	5821	43.5	1106	36.3	921	228.0	5792	42.0	1068	35.6	904
390	229.2	5821	43.5	1106	36.3	921	n/a					
410	266.2	6760	46.3	1177	36.3	921	266.3	6763	44.6	1133	35.5	902
450	287	7290	46.5	1180	38	964	288.5	7329	44.6	1134	37.1	942
500	287.7	7308	45.5	1156	37.6	955	289.1	7344	43.9	1114	36.8	934
520	287.7	7308	45.5	1156	37.6	955	n/a					

(a) Model number digit 8 = C, D, or E.

(b) Model number digit 8 = F.

Table 9. Centers of gravity, units with free-cooling

Unit Size (tons)	All units (except 575V) ^(a)						575V Units ^(b)					
	CGx		CGy		CGz		CGx		CGy		CGz	
	in	mm	in	mm	in	mm	in	mm	in	mm	in	mm
115	99.8	2534	46.3	1176	37.9	962	102.4	2602	45.4	1152	37.3	948
130	99.7	2533	46.3	1175	37.7	957	102.4	2600	45.4	1152	37.1	943
150	110.2	2799	46.1	1170	37.8	961	113.7	2888	45.4	1152	37.3	948
170	110.1	2797	46.1	1170	37.8	960	113.6	2886	45.4	1152	37.3	947
180	110.4	2805	46.6	1185	37.3	946	113.9	2892	45.9	1167	36.8	935
200	120.4	3057	45.5	1156	38	965	124.6	3166	44.9	1140	37.5	952
215	120.4	3058	46	1169	37.5	953	124.5	3163	45.4	1153	37.0	941
230	123.6	3140	45.5	1156	35.9	911	n/a					
250	126.1	3202	45.5	1156	35.9	911						
270	n/a											
280	188	4775	46.5	1181	37.2	944	190.8	4846.0	45.2	1148	36.4	925
310	219.3	5571	46	1169	37.9	963	218.1	5541.0	44.8	1137	37.3	947
350	222.8	5659	45.5	1155	37.7	956	n/a					
390	n/a											
410	259.8	6598	48.1	1222	37.6	956	260.2	6609.0	46.6	1183	36.9	938
450	282.4	7172	48.4	1230	39.4	1001	284.0	7214.0	46.8	1189	38.5	979
500	283.1	7191	47.5	1207	39.1	992	n/a					
520	n/a											

(a) Model number digit 8 = C, D, or E.

(b) Model number digit 8 = F.

Isolation and Sound Emission

The most effective form of isolation is to locate the unit away from any sound sensitive area. Structurally transmitted sound can be reduced by elastomeric vibration eliminators. Spring isolators are not recommended. Consult an acoustical engineer in critical sound applications.

For maximum isolation effect, isolate water lines and electrical conduit. Wall sleeves and rubber isolated piping hangers can be used to reduce the sound transmitted through water piping. To reduce the sound transmitted through electrical conduit, use flexible electrical conduit.

State and local codes on sound emissions should always be considered. Since the environment in which a sound source is located affects sound pressure, unit placement must be carefully evaluated. Sound power levels for Sintesis™ chillers are available on request.

Unit Isolation and Leveling

For additional reduction of sound and vibration, install the optional elastomeric isolators.

Construct an isolated concrete pad for the unit or provide concrete footings at the unit mounting points. Mount the unit directly to the concrete pads or footings.

Level the unit using the base rail as a reference. The unit must be level within 1/2 in (12 mm) over the entire length and width. Use shims as necessary to level the unit.

Elastomeric Isolators

Note: See unit submittal, or [Table 14, p. 26 thru Table 18, p. 30](#) for point weights, isolator location and isolator selections.

1. Secure the isolators to the mounting surface using the mounting slots in the isolator base plate. Do not fully tighten the isolator mounting bolts at this time.
2. Align the mounting holes in the base of the unit with the threaded positioning pins on the top of the isolators.
3. Lower the unit onto the isolators and secure the isolator to the unit with a nut.
4. Level the unit carefully. Fully tighten the isolator mounting bolts.

Figure 9. Elastomeric isolator

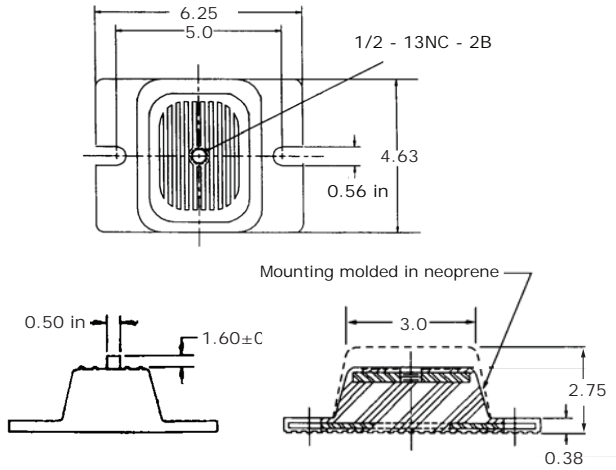
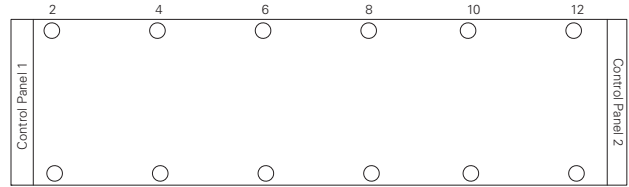

Figure 11. Mounting point locations^(a)



(a) Quantity of mounting points and isolators varies with unit. See submittal for actual number required for specific unit size. Control panel 2 is only present on 280 to 520 ton units.

Table 10. Isolator specifications

Type	Color	Ext	Max Load (lbs)	Max Deflection
RDP-4	Brown	61	1500	0.50
RDP-4	Red	62	2250	0.50
RDP-4	Lime	63	3000	0.50
RDP-4	Charcoal	64	4000	0.50

Elastomeric Isolation Pads for Windload Option

Elastomeric pads ship inside the unit control panel. They are provided with an isolation washer and 3/4" free hole in the center of the plate.

Figure 10. Seismic isolation pad – installed

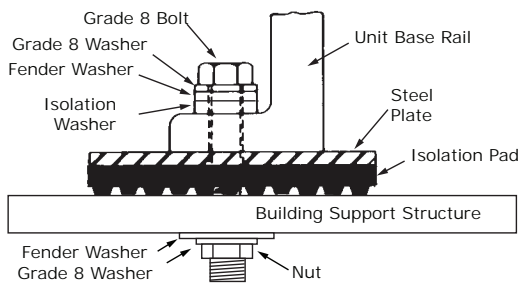

(Washers under support structure recommended if job site has an I-beam or C-channel.)

Table 11. Seismically rated elastomeric isolation pad

Model	Max Load	Dimension (in)		
		Length	Width	Height
B-36	2520	6	6	.625

Table 12. Isolator locations, I-P units (in)^(a)

Unit Size (tons)	Location											
	1	2	3	4	5	6	7	8	9	10	11	12
115	22.8	22.8	100.4	100.4	198.8	198.8	-	-	-	-	-	-
130	22.8	22.8	100.4	100.4	198.8	198.8	-	-	-	-	-	-
150	22.8	22.8	138.9	138.9	243.1	243.1	-	-	-	-	-	-
170	22.8	22.8	138.9	138.9	243.1	243.1	-	-	-	-	-	-
180	22.8	22.8	138.9	138.9	243.1	243.1	-	-	-	-	-	-
200	22.8	22.8	105.4	105.4	204.7	204.7	287.5	287.5	-	-	-	-
215	22.8	22.8	105.4	105.4	204.7	204.7	287.5	287.5	-	-	-	-
230	22.8	22.8	105.4	105.4	204.7	204.7	287.4	287.4	-	-	-	-
250/270	22.8	22.8	105.4	105.4	204.7	204.7	287.4	287.4	-	-	-	-
280	18.8	18.8	129.1	129.1	269.6	269.6	379.8	379.8	-	-	-	-
310	18.8	18.8	129.1	129.1	239.3	239.3	313.9	313.9	424.1	424.1	-	-
350/390	18.8	18.8	129.1	129.1	239.3	239.3	313.9	313.9	424.1	424.1	-	-
410	18.8	18.8	129.1	129.1	239.3	239.3	402.6	402.6	512.8	512.8	-	-
450	60.2	40.1	142.1	129.1	223.6	239.3	334.6	323.9	442.0	445.8	540.4	548.1
500/520	60.2	40.1	142.1	129.1	223.6	239.3	334.6	323.9	442.0	445.8	540.4	548.1

(a) Dimensions are referenced from end of the unit on the circuit 1 control panel side (not including control panel itself).

Table 13. Isolator locations, SI units (mm)^(a)

Unit Size (tons)	Location											
	1	2	3	4	5	6	7	8	9	10	11	12
115	578	578	2550	2550	5050	5050	-	-	-	-	-	-
130	578	578	2550	2550	5050	5050	-	-	-	-	-	-
150	578	578	3528	3528	6174	6174	-	-	-	-	-	-
170	578	578	3528	3528	6174	6174	-	-	-	-	-	-
180	578	578	3528	3528	6174	6174	-	-	-	-	-	-
200	578	578	2678	2678	5199	5199	7302	7302	-	-	-	-
215	578	578	2678	2678	5199	5199	7302	7302	-	-	-	-
230	578	578	2678	2678	5199	5199	7299	7299	-	-	-	-
250/270	578	578	2678	2678	5199	5199	7299	7299	-	-	-	-
280	478	478	3278	3278	6848	6848	9648	9648	-	-	-	-
310	478	478	3278	3278	6078	6078	7973	7973	10773	10773	-	-
350/390	478	478	3278	3278	6078	6078	7973	7973	10773	10773	-	-
410	478	478	3278	3278	6078	6078	10225	10225	13025	13025	-	-
450	1529	1018	3609	3278	5679	6078	8500	8228	11226	11324	13726	13923
500/520	1529	1018	3609	3278	5679	6078	8500	8228	11226	11324	13726	13923

(a) Dimensions are referenced from end of the unit on the circuit 1 control panel side (not including control panel itself).



Installation Mechanical

Table 14. Point weights, I-P units (lb), units without free-cooling

Unit Size (tons)	Location											12
	1	2	3	4	5	6	7	8	9	10	11	
All Units (Except 575V) ^(a)												
115	1567	1601	1496	1530	937	960	-	-	-	-	-	-
130	1589	1623	1517	1551	951	973	-	-	-	-	-	-
150	2342	2386	1420	1445	1009	1025	-	-	-	-	-	-
170	2294	2332	1557	1586	940	959	-	-	-	-	-	-
180	2169	2658	1621	1489	1077	989	-	-	-	-	-	-
200	2189	2146	1734	1702	923	907	711	699	-	-	-	-
215	2303	2159	1761	1653	901	1271	673	634	-	-	-	-
230	2386	2379	1852	1847	1445	1441	729	727	-	-	-	-
250/270	2228	2223	2035	2030	1353	1349	805	803	-	-	-	-
280	2086	2235	2029	2178	1956	2105	1899	2048	-	-	-	-
310	1708	1801	1716	1812	1724	1823	1730	1830	1736	1841	-	-
350/390	1656	1612	1578	2046	2000	1942	1929	1872	1825	1768	-	-
410	2106	2188	2059	2141	2011	2094	1941	2698	1894	2635	-	-
450	2041	1995	2079	2036	1588	2087	1626	2126	1664	2183	1698	2230
500/520	1921	2171	1912	2161	1903	2149	1891	2140	1880	2127	1869	2116
575V Units ^(b)												
115	1579	1539	1614	1575	1105	1078	-	-	-	-	-	-
130	1601	1559	1634	1594	1118	1092	-	-	-	-	-	-
150	2298	2249	1672	1634	1083	1059	-	-	-	-	-	-
170	2309	2260	1678	1641	1085	1061	-	-	-	-	-	-
180	2333	2366	1705	1729	1109	1125	-	-	-	-	-	-
200	2241	2126	1678	1592	1118	1061	818	776	-	-	-	-
215	2269	2225	1702	1667	1134	1111	831	814	-	-	-	-
230	2532	2459	1859	1804	1358	1317	887	858	-	-	-	-
250	2600	2091	1868	2007	1328	1431	845	913	-	-	-	-
280	2236	2234	2196	2194	2144	2141	2104	2099	-	-	-	-
310	1877	1852	1874	1848	1870	1846	1868	1844	1866	1839	-	-
350	1888	1806	1923	1841	1958	1877	1983	1901	2018	1936	-	-
410	2298	2210	2254	2166	2207	2119	2141	2737	2095	2675	-	-
450	1974	2141	1969	2139	1967	2135	1963	2132	1958	2126	1954	2124
500	2069	2166	2069	2166	2069	2166	2071	2166	2071	2166	2071	2166

(a) Model number digit 8 = C, D, or E.

(b) Model number digit 8 = F.

Table 15. Point weights, I-P units (lb), units with free-cooling

Unit Size (tons)	Location											
	1	2	3	4	5	6	7	8	9	10	11	12
All Units (Except 575V) ^(a)												
115	1565	2040	1505	1960	1429	1394	-	-	-	-	-	-
130	1586	2063	1524	1980	1446	1407	-	-	-	-	-	-
150	2429	2875	1738	2073	1248	1498	-	-	-	-	-	-
170	2617	2857	1429	2085	1390	1525	-	-	-	-	-	-
180	2646	2962	1450	2170	1415	1593	-	-	-	-	-	-
200	2471	2684	1777	1936	1263	1383	804	1325	-	-	-	-
215	2478	2535	1797	2453	1292	1324	830	1278	-	-	-	-
230	2745	2965	2012	2176	1466	1590	954	1554	-	-	-	-
250	2684	2896	2007	2166	1499	1619	996	1614	-	-	-	-
280	2918	3064	2141	3001	2080	2920	2033	2857	-	-	-	-
310	2088	2651	2036	2581	1983	2511	1948	2463	1895	2393	-	-
350	2100	2594	2081	2568	2062	2543	2049	2526	2030	2501	-	-
410	2113	2584	2112	2583	2110	2581	2108	2579	2106	2577	-	-
450	2087	2969	2064	2936	2042	2896	2011	2868	1982	2820	1954	2783
500	2192	2992	2172	2963	2153	2928	2126	2903	2100	2862	2076	2829
575V Units ^(b)												
115	1596	1997	1592	1993	1587	1490	-	-	-	-	-	-
130	1618	2022	1612	2013	1603	1501	-	-	-	-	-	-
150	2447	2818	1845	2123	1391	1598	-	-	-	-	-	-
170	2458	2829	1852	2130	1393	1603	-	-	-	-	-	-
180	2487	2934	1876	2213	1415	1669	-	-	-	-	-	-
200	2026	2760	2030	2075	1526	1561	1019	1043	-	-	-	-
215	2187	2855	2088	2041	1475	1440	933	1365	-	-	-	-
230	-	-	-	-	-	-	-	-	-	-	-	-
250	-	-	-	-	-	-	-	-	-	-	-	-
280	3064	3031	2282	3007	2260	2978	2242	2954	-	-	-	-
310	2147	2696	2141	2687	2134	2679	2130	2672	2121	1997	-	-
350	-	-	-	-	-	-	-	-	-	-	-	-
410	2456	3183	2458	3186	2460	3188	2463	3190	2465	3194	-	-
450	2240	2963	2227	2941	2211	2917	2191	2897	2174	2868	2156	2844
500	-	-	-	-	-	-	-	-	-	-	-	-

(a) Model number digit 8 = C, D, or E.

(b) Model number digit 8 = F.



Installation Mechanical

Table 16. Point weights, SI units (kg), units without free-cooling

Unit Size (tons)	Location											
	1	2	3	4	5	6	7	8	9	10	11	12
All Units (Except 575V) ^(a)												
115	711	726	678	694	425	435	-	-	-	-	-	-
130	721	736	688	704	431	442	-	-	-	-	-	-
150	1062	1082	644	656	457	465	-	-	-	-	-	-
170	1041	1058	706	719	427	435	-	-	-	-	-	-
180	984	1206	735	675	488	449	-	-	-	-	-	-
200	993	974	787	772	419	411	322	317	-	-	-	-
215	1045	979	799	750	409	576	305	287	-	-	-	-
230	1082	1079	840	838	655	654	331	330	-	-	-	-
250/270	1011	1008	923	921	614	612	365	364	-	-	-	-
280	946	1014	920	988	887	955	861	929	-	-	-	-
310	775	817	779	822	782	827	785	830	788	835	-	-
350/390	751	731	716	928	907	881	875	849	828	802	-	-
410	955	993	934	971	912	950	881	1224	859	1195	-	-
450	926	905	943	924	720	947	738	965	755	990	770	1012
500/520	871	985	867	980	863	975	858	971	853	965	848	960
575V units ^(b)												
115	716	698	732	714	501	489	-	-	-	-	-	-
130	726	707	741	723	507	495	-	-	-	-	-	-
150	1042	1020	758	741	491	480	-	-	-	-	-	-
170	1047	1025	761	744	492	481	-	-	-	-	-	-
180	1058	1073	773	784	503	510	-	-	-	-	-	-
200	1016	964	761	722	507	481	371	352	-	-	-	-
215	1029	1009	772	756	514	504	377	369	-	-	-	-
230	1148	1115	843	818	616	597	402	389	-	-	-	-
250	1179	948	847	910	602	649	383	414	-	-	-	-
280	1014	1013	996	995	972	971	954	952	-	-	-	-
310	851	840	850	838	848	837	847	836	846	834	-	-
350	856	819	872	835	888	851	899	862	915	878	-	-
410	1042	1002	1022	982	1001	961	971	1241	950	1213	-	-
450	895	971	893	970	892	968	890	967	888	964	886	963
500	938	982	938	982	938	982	939	982	939	982	939	982

(a) Model number digit 8 = C, D, or E.

(b) Model number digit 8 = F.

Table 17. Point weights, SI units (kg), units with free-cooling

Unit Size (tons)	Location											
	1	2	3	4	5	6	7	8	9	10	11	12
All Units (Except 575V) ^(a)												
115	710	925	683	889	648	632	-	-	-	-	-	-
130	719	936	691	898	656	638	-	-	-	-	-	-
150	1102	1304	789	940	566	680	-	-	-	-	-	-
170	1187	1296	648	946	631	692	-	-	-	-	-	-
180	1200	1344	658	984	642	722	-	-	-	-	-	-
200	1121	1217	806	878	573	627	365	601	-	-	-	-
215	1124	1150	815	1113	586	601	377	579	-	-	-	-
230	1245	1345	912	987	665	721	433	705	-	-	-	-
250	1217	1314	910	982	680	734	452	732	-	-	-	-
280	1324	1390	971	1361	944	1324	922	1296	-	-	-	-
310	947	1202	923	1171	900	1139	883	1117	859	1086	-	-
350	952	1176	944	1165	935	1154	930	1146	921	1134	-	-
410	958	1172	958	1171	957	1171	956	1170	955	1169	-	-
450	946	1347	936	1332	926	1314	912	1301	899	1279	887	1262
500	994	1357	985	1344	976	1328	964	1317	953	1298	942	1283
575V Units ^(b)												
115	724	906	722	904	720	676	-	-	-	-	-	-
130	734	917	731	913	727	681	-	-	-	-	-	-
150	1110	1278	837	963	631	725	-	-	-	-	-	-
170	1115	1283	840	966	632	727	-	-	-	-	-	-
180	1128	1331	851	1004	642	757	-	-	-	-	-	-
200	919	1252	921	941	692	708	462	473	-	-	-	-
215	992	1295	947	926	669	653	423	619	-	-	-	-
230	-	-	-	-	-	-	-	-	-	-	-	-
250	-	-	-	-	-	-	-	-	-	-	-	-
280	1390	1375	1035	1364	1025	1351	1017	1340	-	-	-	-
310	974	1223	971	1219	968	1215	966	1212	962	906	-	-
350	-	-	-	-	-	-	-	-	-	-	-	-
410	1114	1444	1115	1445	1116	1446	1117	1447	1118	1449	-	-
450	1016	1344	1010	1334	1003	1323	994	1314	986	1301	978	1290
500	-	-	-	-	-	-	-	-	-	-	-	-

(a) Model number digit 8 = C, D, or E.

(b) Model number digit 8 = F.



Installation Mechanical

Table 18. Isolator selections

Unit Size (tons)	Location											
	1	2	3	4	5	6	7	8	9	10	11	12
Units Without Free-Cooling Option												
115	Red 62	Red 62	Red 62	Red 62	Brown 61	Brown 61	-	-	-	-	-	-
130	Red 62	Red 62	Red 62	Red 62	Brown 61	Brown 61	-	-	-	-	-	-
150	Char 64	Char 64	Red 62	Red 62	Brown 61	Brown 61	-	-	-	-	-	-
170	Char 64	Char 64	Red 62	Red 62	Brown 61	Brown 61	-	-	-	-	-	-
180	Char 64	Char 64	Red 62	Red 62	Brown 61	Brown 61	-	-	-	-	-	-
200	Char 64	Char 64	Char 64	Char 64	Red 62	Red 62	Brown 61	Brown 61	-	-	-	-
215	Char 64	Char 64	Char 64	Char 64	Red 62	Red 62	Brown 61	Brown 61	-	-	-	-
230	Lime 63	Lime 63	Lime 63	Lime 63	Lime 63	Lime 63	Brown 61	Brown 61	-	-	-	-
250/270	Lime 63	Lime 63	Lime 63	Lime 63	Lime 63	Lime 63	Brown 61	Brown 61	-	-	-	-
280	Lime 63	Lime 63	Lime 63	Lime 63	Lime 63	Lime 63	Lime 63	Lime 63	-	-	-	-
310	Lime 63	Lime 63	Lime 63	Lime 63	Lime 63	Lime 63	Lime 63	Lime 63	Lime 63	Lime 63	-	-
350/390	Lime 63	Lime 63	Lime 63	Lime 63	Lime 63	Lime 63	Lime 63	Lime 63	Lime 63	Lime 63	Lime 63	-
410	Lime 63	Lime 63	Lime 63	Lime 63	Lime 63	Lime 63	Lime 63	Lime 63	Lime 63 ^(a) Char 64 ^(b)	Lime 63	Char 64	-
450	Lime 63	Lime 63	Lime 63	Lime 63	Lime 63	Lime 63	Lime 63	Lime 63	Lime 63	Lime 63	Lime 63	Lime 63
500/520	Lime 63	Lime 63	Lime 63	Lime 63	Lime 63	Lime 63	Lime 63	Lime 63	Lime 63	Lime 63	Lime 63	Lime 63
Units With Free-Cooling Option												
115	Lime 63	Lime 63	Lime 63	Lime 63	Red 62	Red 62	-	-	-	-	-	-
130	Lime 63	Lime 63	Lime 63	Lime 63	Red 62	Red 62	-	-	-	-	-	-
150	Char 64	Char 64	Lime 63	Lime 63	Red 62	Red 62	-	-	-	-	-	-
170	Char 64	Char 64	Lime 63	Lime 63	Red 62	Red 62	-	-	-	-	-	-
180	Char 64	Char 64	Lime 63	Lime 63	Red 62	Red 62	-	-	-	-	-	-
200	Char 64	Char 64	Char 64	Char 64	Red 62	Red 62	Red 62	Red 62	-	-	-	-
215	Char 64	Char 64	Char 64	Char 64	Red 62	Red 62	Red 62	Red 62	-	-	-	-
230	Char 64	Char 64	Char 64	Char 64	Red 62	Red 62	Red 62	Red 62	-	-	-	-
250	Char 64	Char 64	Char 64	Char 64	Red 62	Red 62	Red 62	Red 62	-	-	-	-
280	Char 64	Char 64	Lime 63	Char 64	Lime 63	Char 64	Lime 63	Char 64	-	-	-	-
310	Lime 63	Char 64	Lime 63	Char 64	Lime 63	Char 64	Lime 63	Char 64	Lime 63	Char 64	-	-
350	Lime 63	Char 64	Lime 63	Char 64	Lime 63	Char 64	Lime 63	Char 64	Lime 63	Char 64	-	-
410	Lime 63	Char 64	Lime 63	Char 64	Lime 63	Char 64	Lime 63	Char 64	Lime 63	Char 64	-	-
450	Lime 63	Char 64	Lime 63	Char 64	Lime 63	Char 64	Lime 63	Char 64	Lime 63	Char 64	Lime 63	Char 64
500	Lime 63	Char 64	Lime 63	Char 64	Lime 63	Char 64	Lime 63	Char 64	Lime 63	Char 64	Lime 63	Char 64

(a) All units except those with 575V option. (Applicable if model number digit 8 = C, D, or E.)

(b) Units with 575V selection (model number digit 8 = F).

Chilled Water Piping Recommendations

Water Treatment

NOTICE:

Proper Water Treatment!

The use of untreated or improperly treated water could result in scaling, erosion, corrosion, algae or slime. It is recommended that the services of a qualified water treatment specialist be engaged to determine what water treatment, if any, is required. Trane assumes no responsibility for equipment failures which result from untreated or improperly treated water, or saline or brackish water.

Dirt, scale, products of corrosion, and other foreign material will adversely affect heat transfer between the water and system components. Foreign matter in the chilled-water system can also increase pressure drop and consequently, reduce water flow. Proper water treatment must be determined locally, depending on the type of system and local water characteristics.

NOTICE:

Equipment Damage!

If using any commercial flushing/cleaning solution, construct a temporary bypass around the unit to prevent damage to internal components of the evaporator/condenser. Trane assumes no responsibility for equipment damage caused by flushing/cleaning solutions or water-born debris.

Units with Free-Cooling Option

NOTICE:

Coil Damage!

Failure to follow instructions below could result in free-cooling coil freeze.

For units with free-cooling option, introduction of uninhibited water into the system is not recommended, as it could lead to internal corrosion and risk of coil freeze. To avoid free-cooling coil damage:

- If the building loop needs to be charged with water for testing purposes, isolate free-cooling coils by closing free-cooling service shut-off valve and modulating valve 6M4.
- Completely drain any water inadvertently introduced into the system, and replace with glycol fluid as required for the free-cooling system.
- If water was introduced for hydronic testing, and was not immediately replaced with glycol solution, a glycol (freeze inhibitor) solution must be introduced to the free-cooling system/coils for any long term storage.

Drainage

Locate the unit near a large capacity drain for water vessel drain-down during shutdown or repair. Evaporators are provided with drain connections. A vent on top of evaporator waterbox prevents vacuum by allowing air into evaporator for complete drainage.

Drain connections and vents are also provided on header pipes for use when free-cooling option (model number digit 42 = H) is selection.

All local and national codes apply.

Evaporator Piping

Waterbox Configurations

Evaporator configuration varies with unit size. See figure below for waterbox configurations and component locations.

- 115 to 270 tons: 2-pass evaporator
- 280 to 520 tons: 1-pass evaporator

Note: Flow sensor is installed in the inlet only. See figure below.

Figure 12. Waterbox configurations

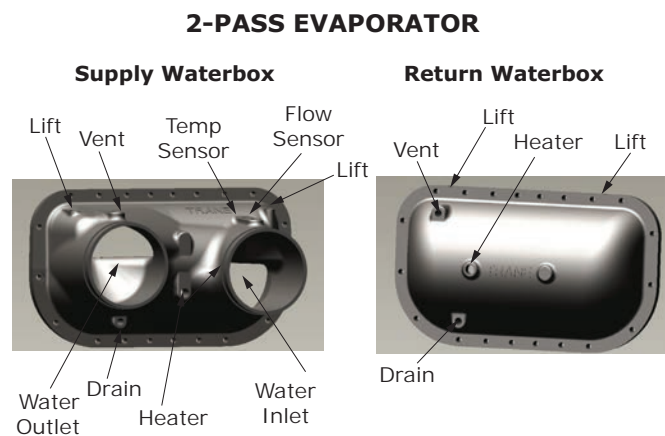

General Piping Information

Evaporator water connections are grooved.

Thoroughly flush all water piping to the unit before making the final piping connections to the unit. Components and layout will vary slightly, depending on the location of connections and the water sources. See "Component Locations," p. 10 for more information.

An air vent is located on each evaporator waterbox. See Figure 12, p. 31. Be sure to provide additional air vents at the highest points in the piping to remove air from the chilled water system. Install necessary pressure gauges to monitor the entering and leaving chilled water pressure.

Provide shut off valves in lines to the gauges to isolate them from the system when they are not in use. Use rubber vibration eliminators to prevent vibration transmission through the water lines.

If desired, install thermometers in the lines to monitor entering and leaving water line to control water flow balance. Install shutoff valves on both the entering and leaving water lines so that the evaporator can be isolated for service.

To prevent damage to chilled-water components, do not allow evaporator pressure (maximum working pressure) to exceed 150 psi (10.5 bar).

Figure 13. Evaporator water piping

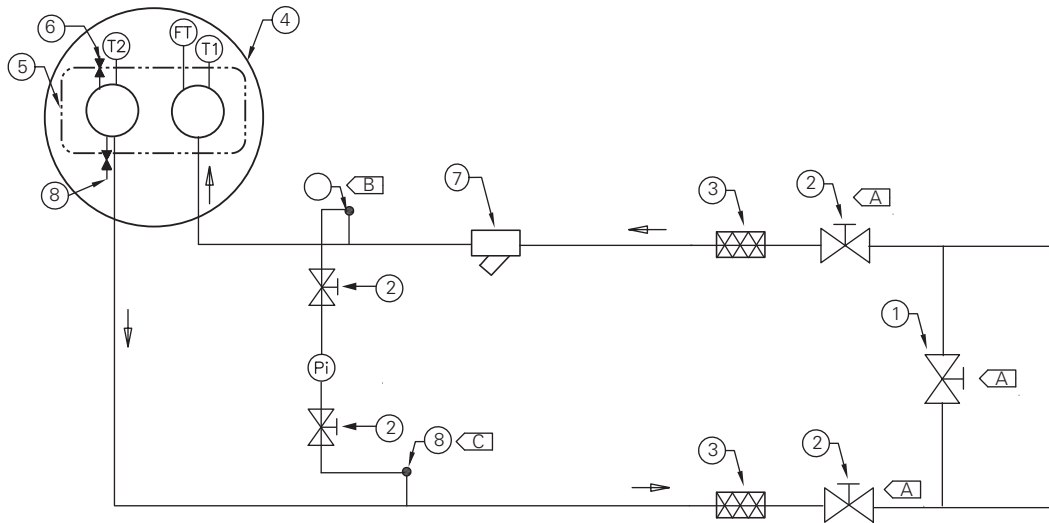

- | | | | |
|---|--------------------------------|----|---|
| 1 | Bypass Valve | Pi | Pressure Gauge |
| 2 | Isolation Valve | FT | Water Flow Switch |
| 3 | Vibration Isolators | T1 | Evaporator Water Inlet Temperature Sensor |
| 4 | Evaporator - End View (2-pass) | T2 | Evaporator Water Outlet Temperature Sensor |
| 5 | Evaporator Waterbox | A | Isolate unit for initial water loop cleaning |
| 6 | Vent | B | Vent must be installed at the high point of the line |
| 7 | Strainer | C | Drains must be installed at the low point of the line |
| 8 | Drain | | |

Note: When free-cooling option is selected, waterside working pressure is 90 psig.

A pipe strainer must be installed in the entering water line. Failure to do so can allow waterborne debris to enter the evaporator.

NOTICE:

Water Box Damage!

The chilled-water connections to the evaporator are to be "grooved pipe" type connections. Do not attempt to weld these connections, because the heat generated from welding can cause microscopic and macroscopic fractures on the cast iron water boxes that can lead to premature failure of the water box. An optional grooved pipe stub and coupling is available for welding on flanges.

Evaporator Piping Components

Piping components include all devices and controls used to provide proper water system operation and unit operating safety. A typical RTAF evaporator piping is shown below.

Entering Chilled Water Piping

- Air vents to bleed the air from the system (to be placed on the highest point)
- Water pressure gauges with shutoff valves
- Vibration eliminators
- Shutoff (isolation) valves
- Thermometers if desired (temperature readings available on chiller controller display)
- Clean-out tees
- Pipe strainer

Leaving Chilled Water Piping

- Air vents to bleed the air from the system (to be placed on the highest point)
- Water pressure gauges with shut off valves
- Vibration eliminators
- Shutoff (isolation) valves
- Thermometers (temperature readings available on the chiller controller display)
- Clean-out tees
- Balancing valve

Waterbox Drains and Vents

NOTICE:

Waterbox Damage!

Failure to follow these instructions could result in damage to the waterbox. Do not use Teflon® pipe tape or overtighten when installing valves, drains, plugs, and vents on cast iron waterboxes.

RTAF chillers are equipped with two 1/2" drain connections, one located on each waterbox. Waterboxes also include vent connections to assist in bleeding air from the chilled water loop. These vent connections should not be assumed to be capable of venting attached chilled water piping. See [Figure 12, p. 31](#) for vent and drain locations.

In order to completely remove water from the evaporator tubes and waterboxes, vent and drain connections on **both** waterboxes should be opened. Use pressurized air to ensure all water is removed from the evaporator. In addition, two-pass **supply** waterboxes should have drainage capability through attached supply water piping. Incomplete drainage increases the risk of damage due to expansion associated with trapped water freezing.

Note: *If evaporator will be drained for winter storage, the heaters must be disconnected to prevent overheating.*

For shipment, drain plugs are removed and placed in a plastic bag in the control panel, and vent plugs remain

installed. Each drain and vent must be piped with a shutoff valve, or plug installed, prior to water pump operation.

For units with free-cooling option (model number digit 42 = H), chiller is equipped with three additional 1/2in NPT drain valves - one on each side of the water strainer and one on the lower header. A vent/bleed valve is located on the upper header.

Pressure Gauges

Install field-supplied pressure components as shown in [Table 13, p. 32](#). Locate pressure gauges or taps in a straight run of pipe; avoid placing them near elbows.

To read manifold pressure gauges, open one valve and close the other (depending on the side of the desired reading) to prevent errors resulting from differently calibrated gauges installed at unmatched elevations.

Pressure Relief Valves

Install a water pressure relief valve in the evaporator inlet piping between evaporator and the inlet shutoff valve. Water vessels with close-coupled shutoff valves have high potential for hydrostatic pressure buildup on a water temperature increase. Refer to applicable local codes for relief valve installation.

Evaporator Flow Switch

NOTICE:

Flow Switch Damage!

Flow switch is on a 24V circuit. Do NOT apply 120V to the flow switch. Incorrect voltage application could cause damage to the flow switch.

The flow switch is factory-installed and programmed based on the operating conditions submitted with the order. The leaving evaporator temperature, fluid type and fluid concentration affect the selected flow switch. If the operating conditions on the job site change, the flow switch may need to be replaced. Contact your local Trane Sales office for more information.

The sensor head includes 3 LEDs, two yellow and one green. Wait 15 seconds after power is applied to the sensor before evaluating LEDs for flow status. When wired correctly and flow is established, only the green LED should be lit. Following are the LED indicators:

- Green ON, both yellow OFF — Flow
- Green and outside yellow ON — No Flow
- Center yellow ON continuously — Miswire

NOTICE:

Equipment Damage!

Incorrect wiring of auxiliary contacts could cause equipment damage.

Installation Mechanical

If using auxiliary flow sensing, both yellow LEDs come on initially when flow is stopped. The center yellow LED will turn off after approximately 7 seconds. The LED indicators are otherwise the same as indicated above.

Indexing Flow Switch

To properly index the flow switch, the following requirements must be met:

- Dot must be at a position no greater than 90° off Index.
- Torque must be between 22 ft-lb and 74 ft-lb.
- A minimum distance of 5x pipe diameter must be maintained between flow switch and any bends, valves, changes in cross sections, etc

Figure 14. Proper flow switch indexing

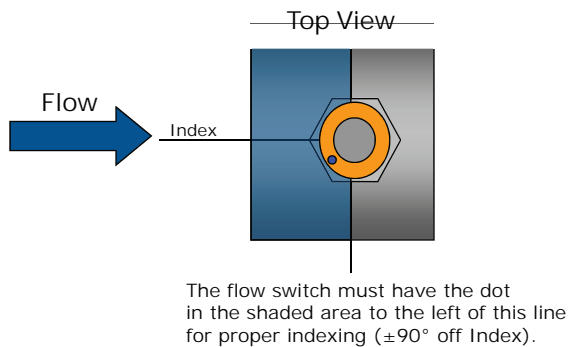

Evaporator Waterside Pressure Drop

Standard Unit

Standard Unit Without Turbulators

Figure 15. Evaporator water pressure drop — 115 to 270 tons, 2-pass without turbulators

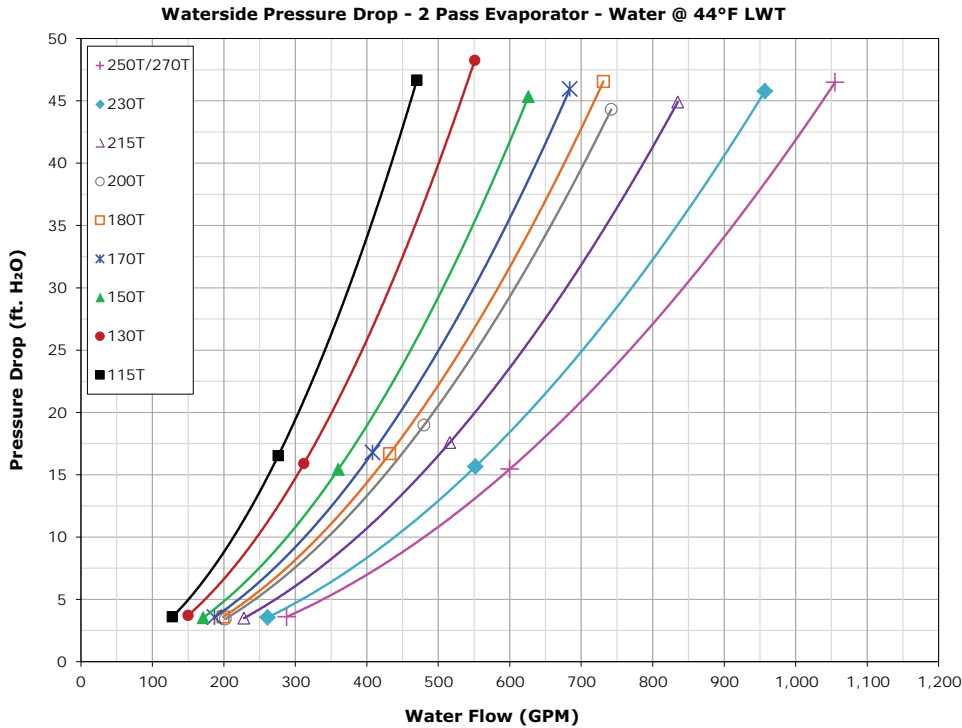
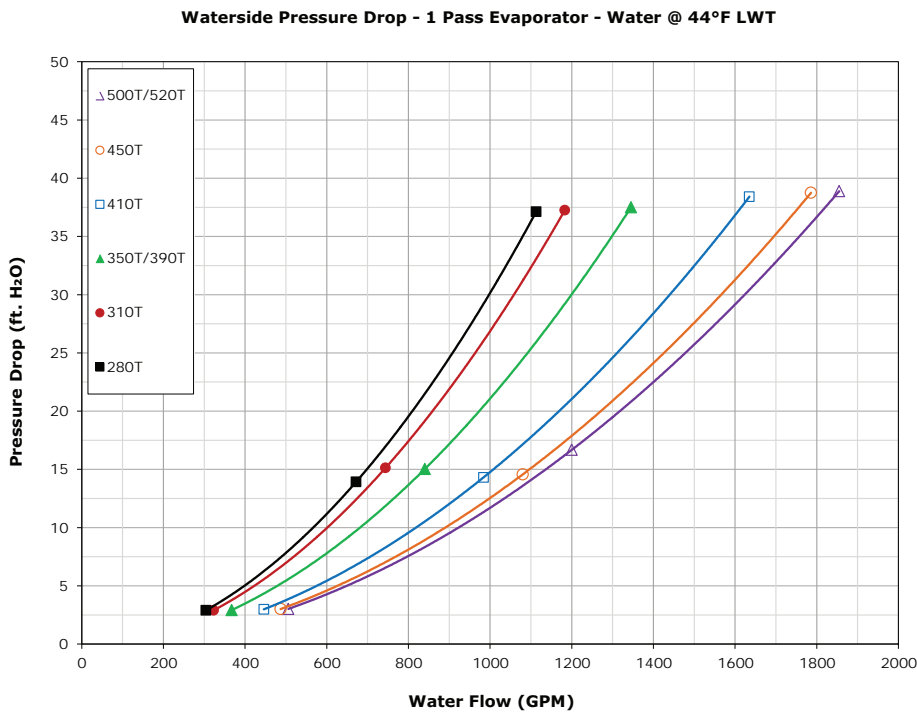

Figure 16. Evaporator water pressure drop — 280 to 520 tons, 1-pass without turbulators



Standard Unit with Turbulators

Figure 17. Evaporator water pressure drop — 115 to 270 tons, 2-pass with turbulators

Waterside Pressure Drop - 2 Pass Evaporator with Tubulators - Water @ 44°F LWT

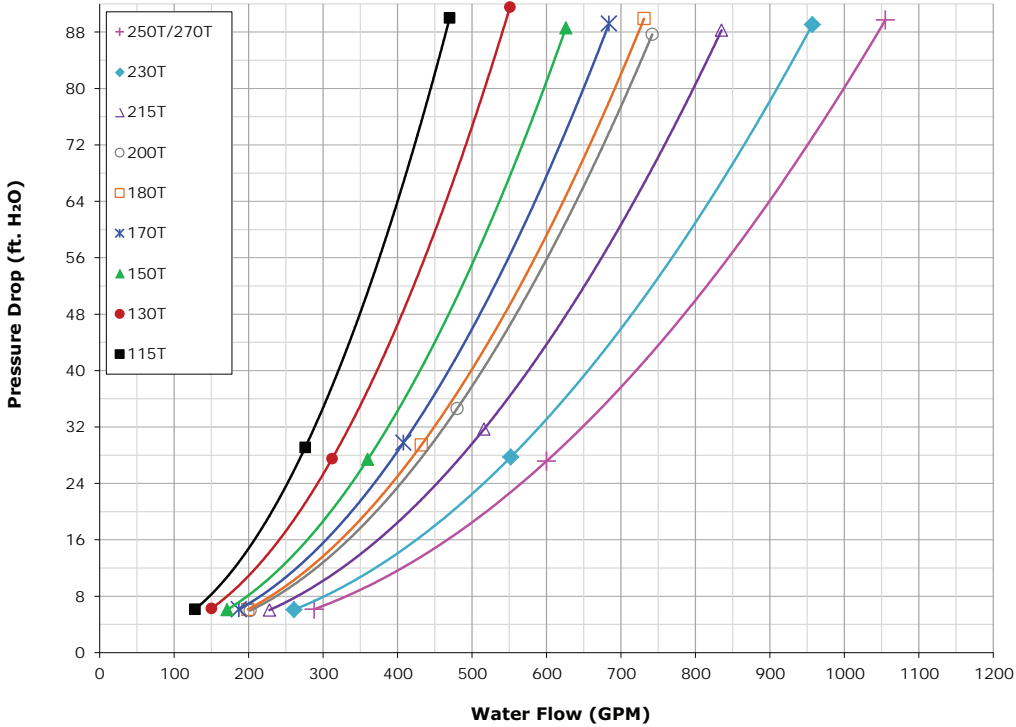
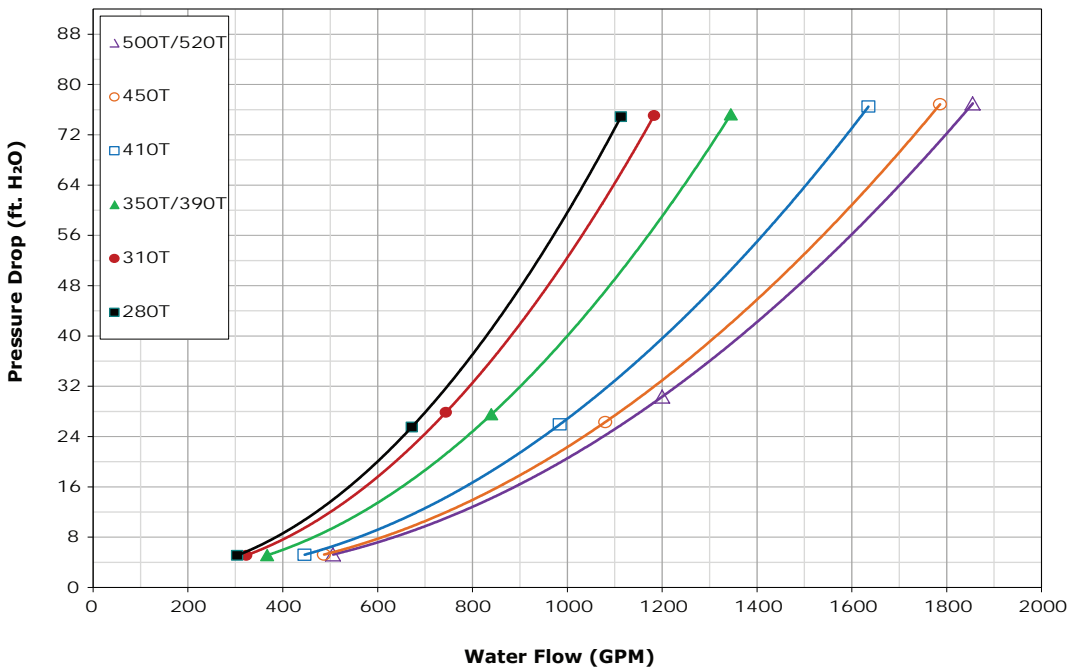

Figure 18. Evaporator water pressure drop — 280 to 520 tons, 1-pass with turbulators

Waterside Pressure Drop - 1 Pass Evaporator with Tubulators - Water @ 44°F LWT



Units with Free-Cooling Option

Free-Cooling Unit with Ethylene Glycol, Without Turbulators

Figure 19. Evaporator water pressure drop, 35% ethylene glycol, free-cooling on – 115 to 250 tons, 2-pass without turbulators

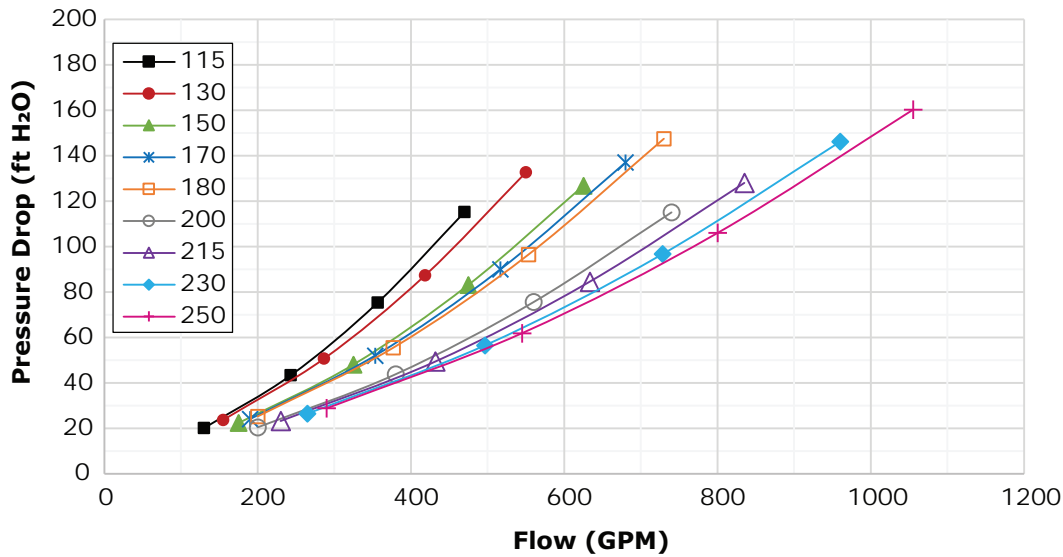

Figure 20. Evaporator water pressure drop, 35% ethylene glycol, free-cooling on – 280 to 500 tons, 1-pass without turbulators

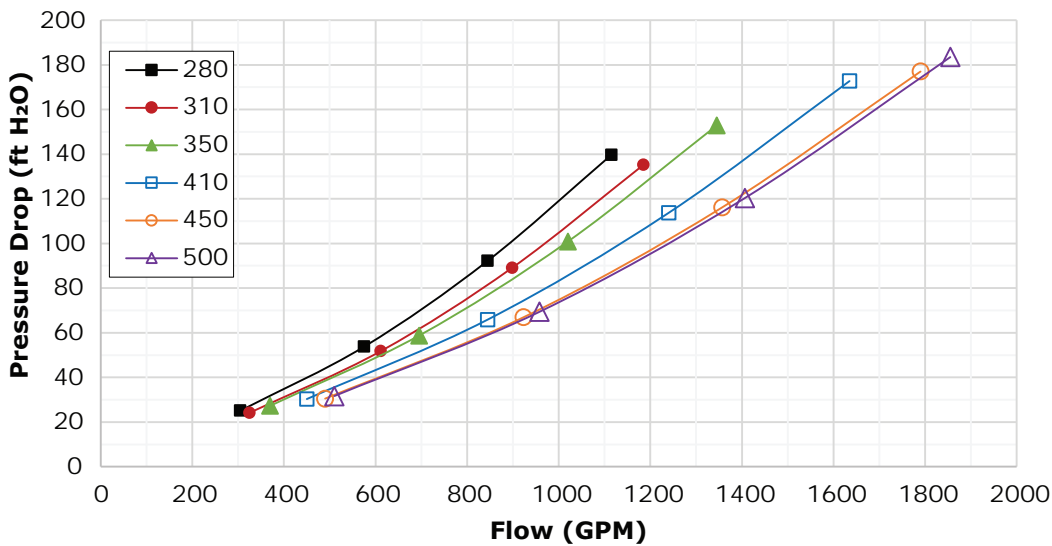

Figure 21. Evaporator water pressure drop, 35% ethylene glycol, free-cooling off – 115 to 250 tons, 2-pass without turbulators

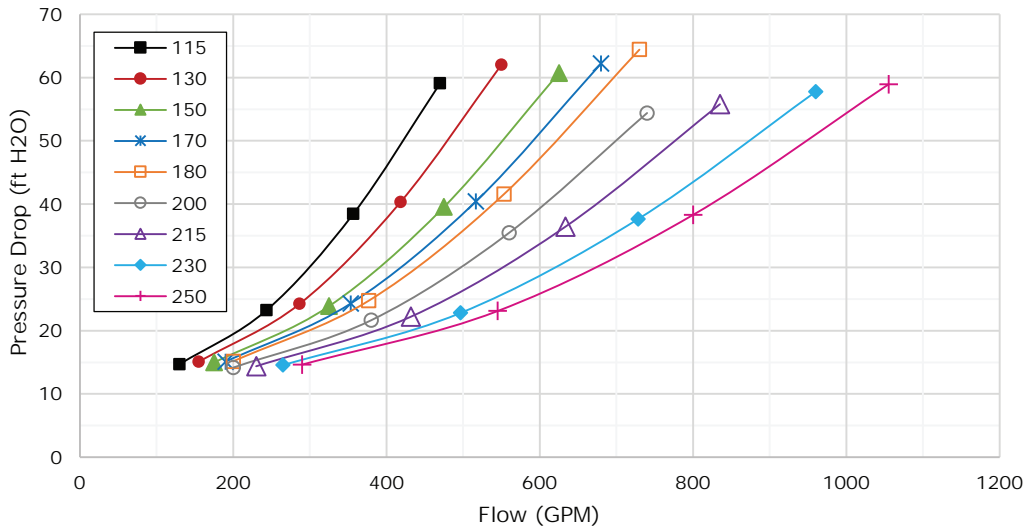
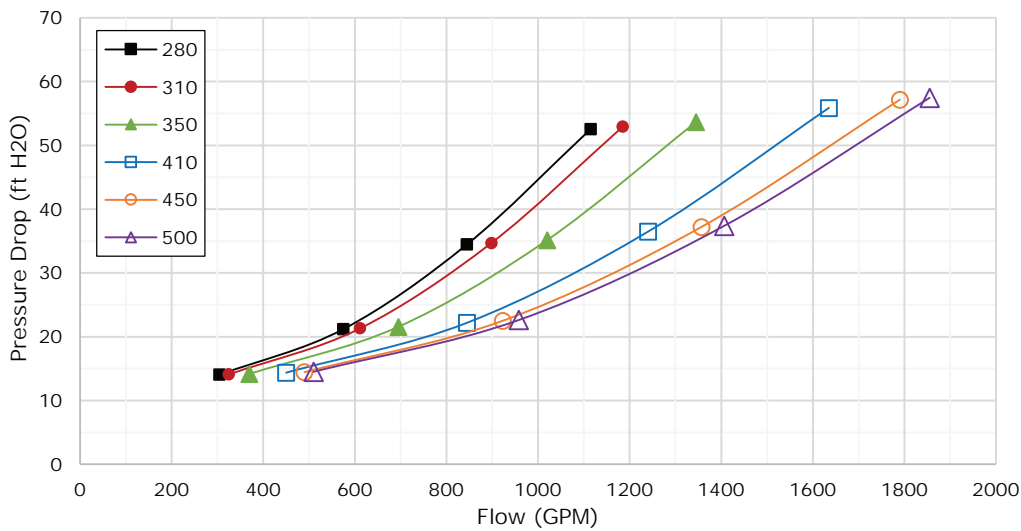

Figure 22. Evaporator water pressure drop, 35% ethylene glycol, free-cooling off – 280 to 500 tons, 1-pass without turbulators



Free-Cooling Unit with Ethylene Glycol, With Turbulators

Figure 23. Evaporator water pressure drop, 35% ethylene glycol, free-cooling on – 115 to 250 tons, 2-pass with turbulators

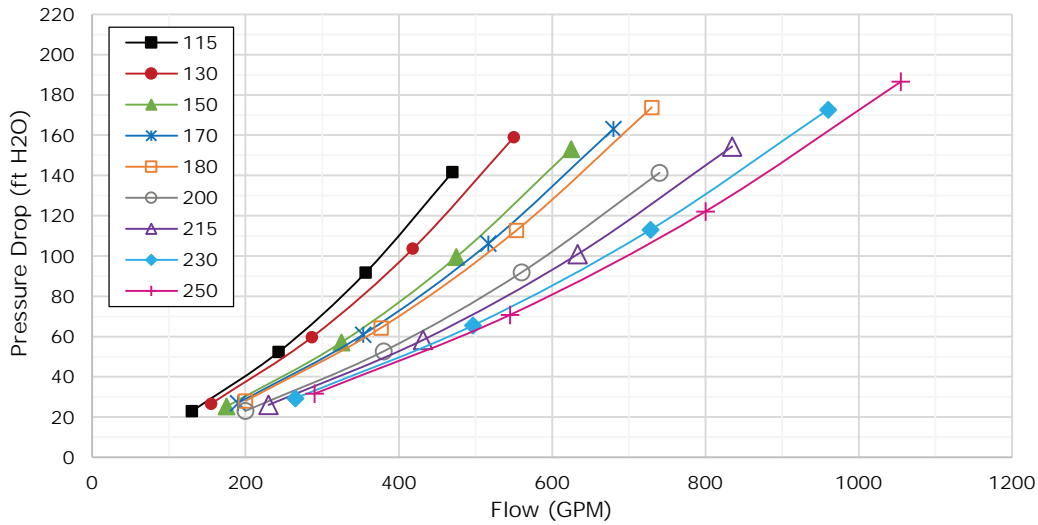

Figure 24. Evaporator water pressure drop, 35% ethylene glycol, free-cooling on – 280 to 500 tons, 1-pass with turbulators

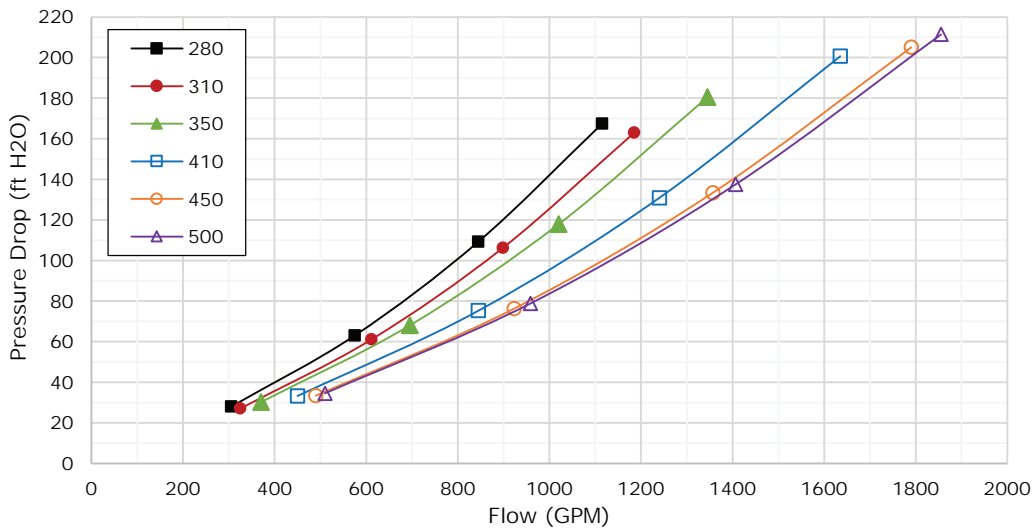

Figure 25. Evaporator water pressure drop, 35% ethylene glycol, free-cooling off – 115 to 250 tons, 2-pass with turbulators

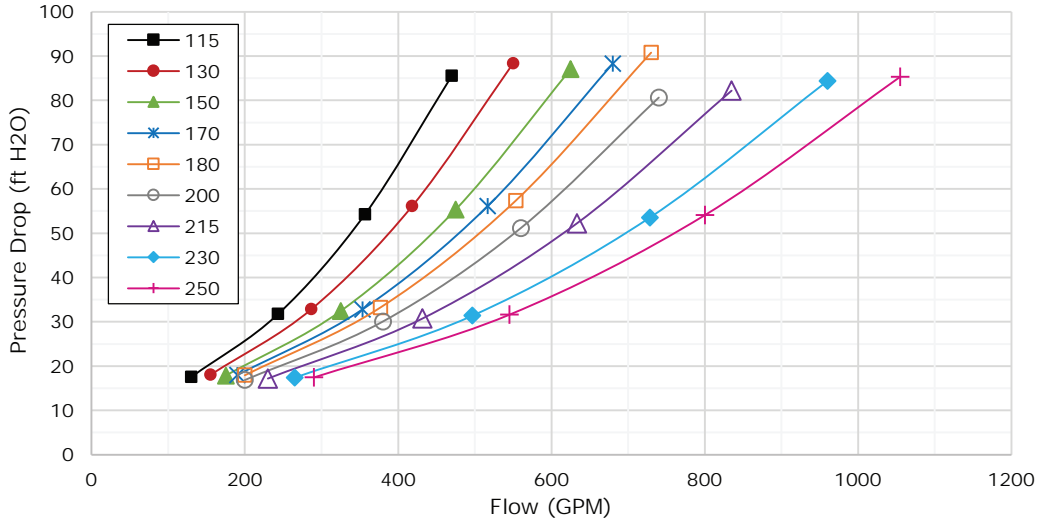
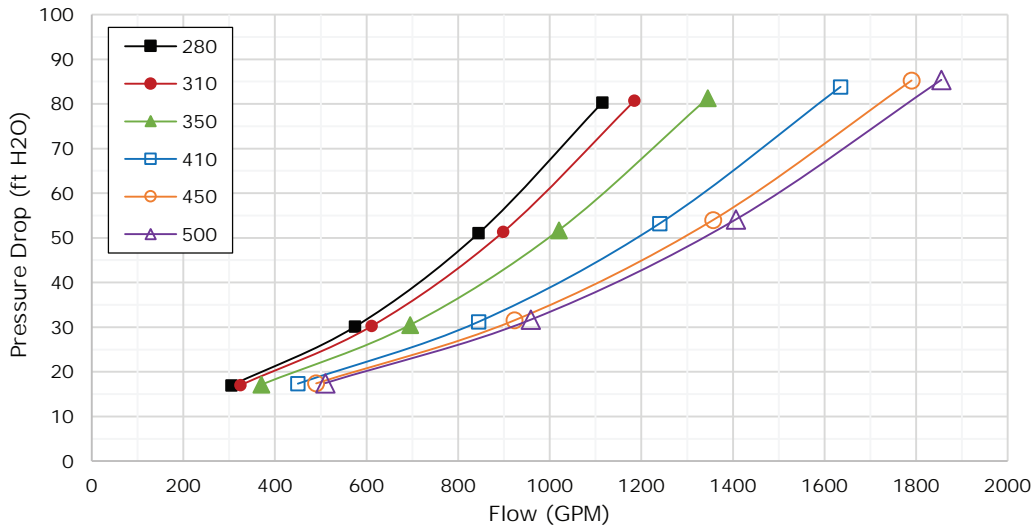

Figure 26. Evaporator water pressure drop, 35% ethylene glycol, free-cooling off – 280 to 500 tons, 1-pass with turbulators



Free-Cooling Unit with Propylene Glycol, Without Turbulators

Figure 27. Evaporator water pressure drop, 35% propylene glycol, free-cooling on – 115 to 250 tons, 2-pass without turbulators

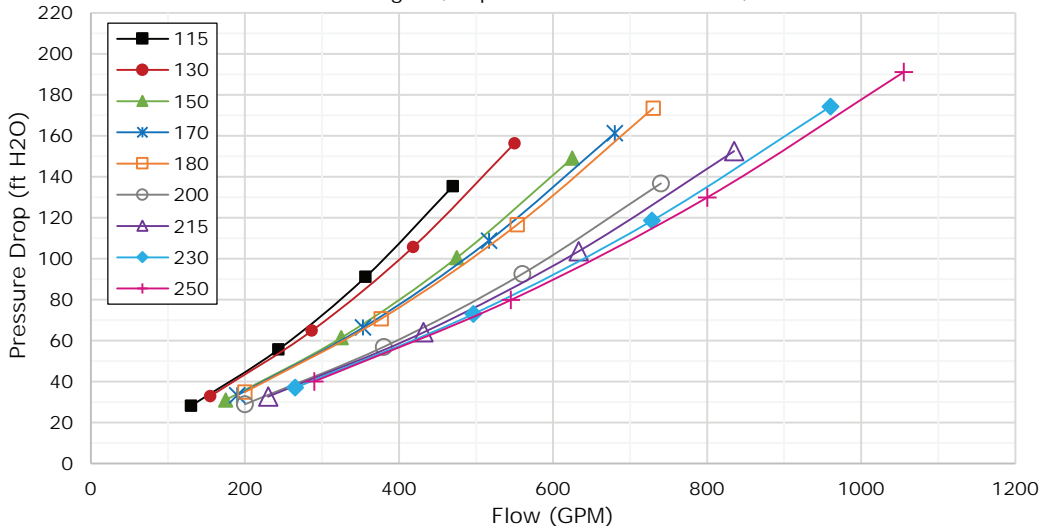

Figure 28. Evaporator water pressure drop, 35% propylene glycol, free-cooling on – 280 to 500 tons, 1-pass without turbulators

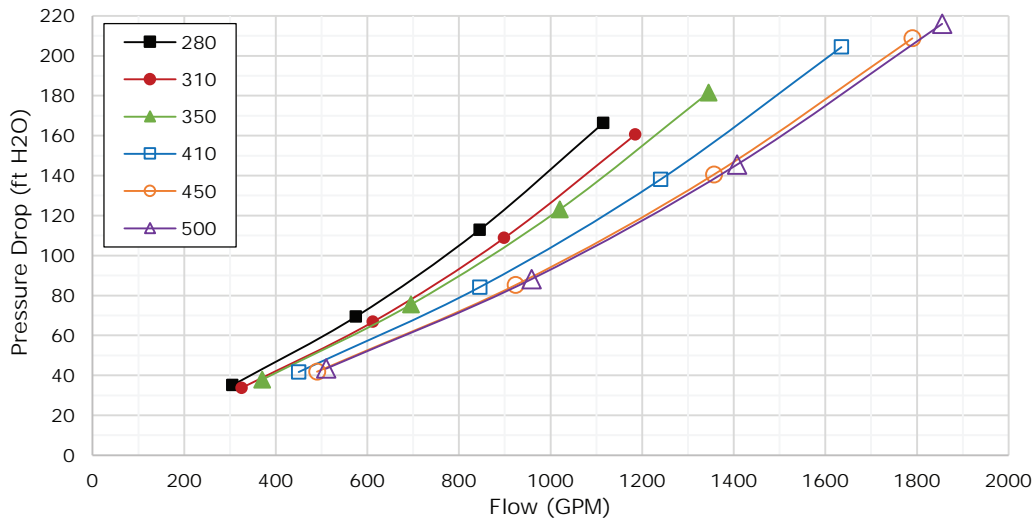

Figure 29. Evaporator water pressure drop, 35% propylene glycol, free-cooling off – 115 to 250 tons, 2-pass without turbulators

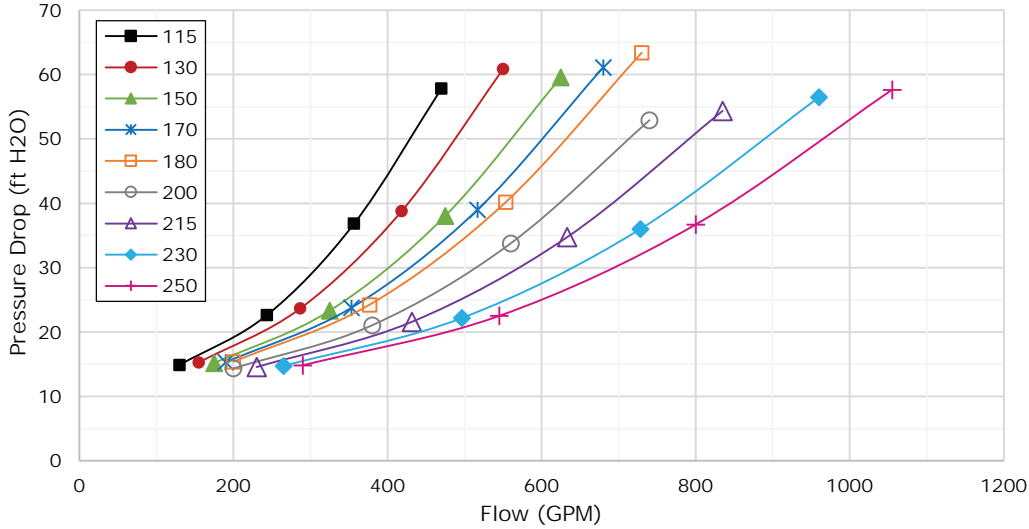
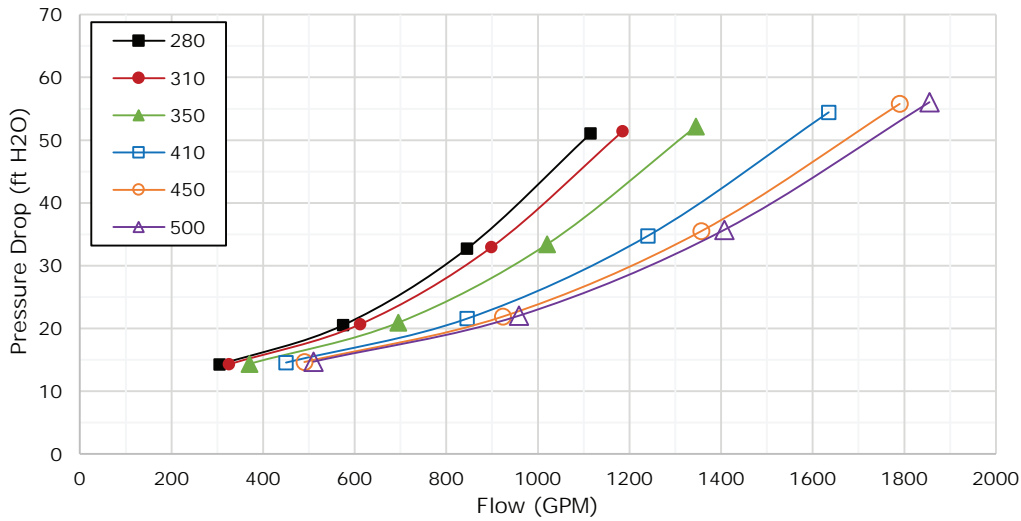

Figure 30. Evaporator water pressure drop, 35% propylene glycol, free-cooling off – 280 to 500 tons, 1-pass without turbulators



Free-Cooling Unit with Propylene Glycol, With Turbulators

Figure 31. Evaporator water pressure drop, 35% propylene glycol, free-cooling on – 115 to 250 tons, 2-pass with turbulators

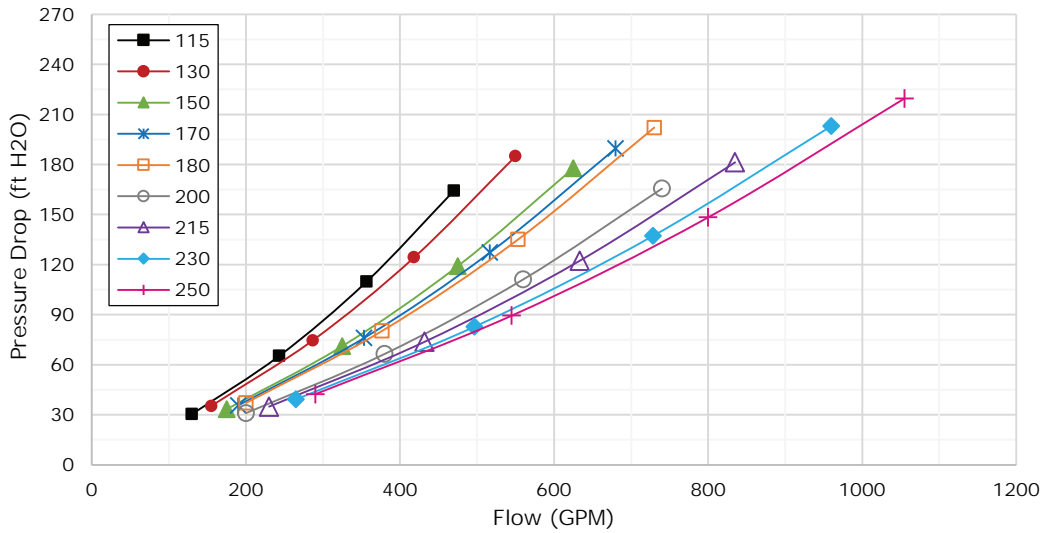

Figure 32. Evaporator water pressure drop, 35% propylene glycol, free-cooling on – 280 to 500 tons, 1-pass with turbulators

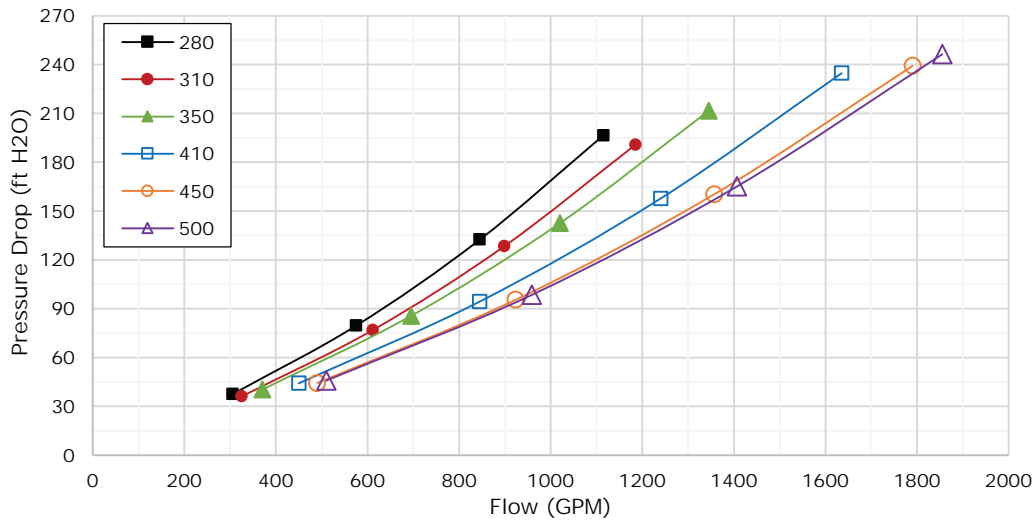

Figure 33. Evaporator water pressure drop, 35% propylene glycol, free-cooling off – 115 to 250 tons, 2-pass with turbulators

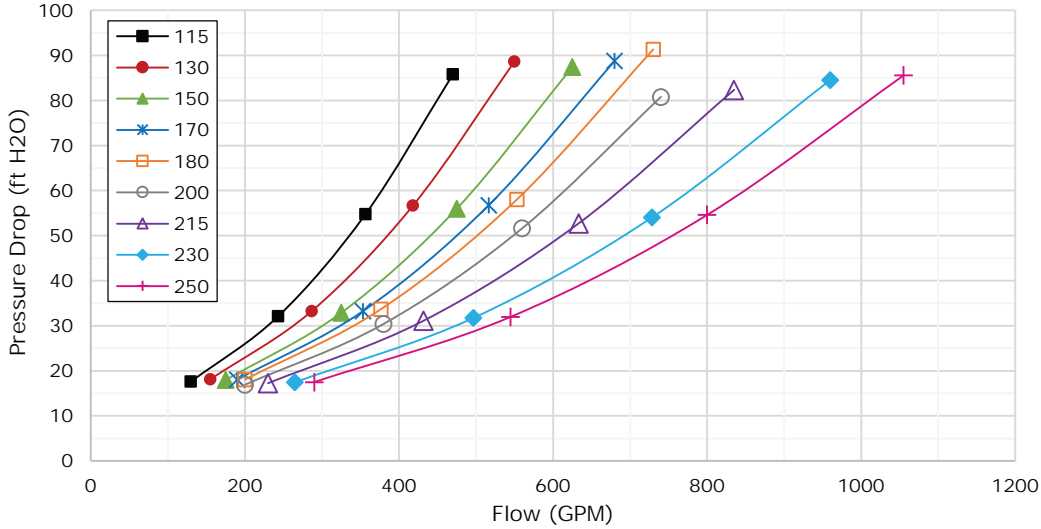
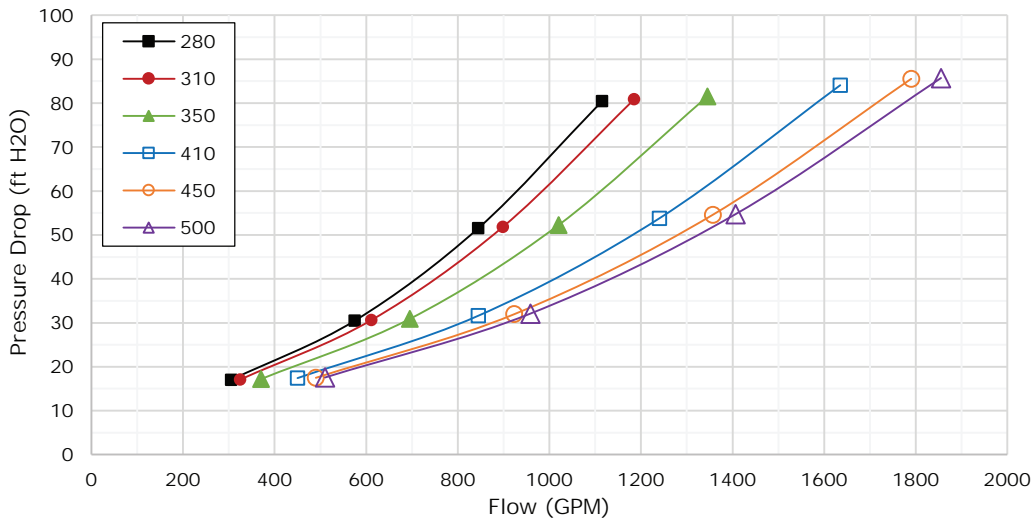

Figure 34. Evaporator water pressure drop, 35% propylene glycol, free-cooling off – 280 to 500 tons, 1-pass with turbulators



Freeze Avoidance

One or more of the ambient freeze avoidance methods in table below must be used to protect the Sintesis™ chiller from ambient freeze damage.

Table 19. RTAF freeze avoidance methods

Method	Protection Range	Notes
Water Pump Control AND Heaters	Down to -4°F	<ul style="list-style-type: none"> • Heaters alone will provide low ambient protection down to -4°F (-20°C), but will NOT protect the evaporator from freezing as a result of charge migration. Therefore, it is required that water pump control be used in conjunction with heaters. • Heaters are factory-installed on the evaporator and water piping and will protect them from freezing. • Install heat tape on all water piping, pumps, and other components that may be damaged if exposed to freezing temperatures. Heat tape must be designed for low ambient temperature applications. Heat tape selection should be based on the lowest expected ambient temperature. • Tracer™ UC800 controller can start the pump when freezing conditions are detected. For this option the pump must be controlled by the Sintesis unit and this function must be validated. • Water circuit valves need to stay open at all times. • Water pump control and heater combination will protect the evaporator provided power is available to the pump and the controller. This option will NOT protect the evaporator in the event of a power failure to the chiller unless backup power is supplied to the necessary components. • When no chiller operation is possible and the pump is already off, UC800 pump control for freeze protection will command the pump to turn: <ul style="list-style-type: none"> ON if the respective circuit's LERTC Integral was seen to be >0 for a period of time. The LERTC integral is increased if the Evap Refrigerant Pool Temp is below the value of the Low Evap Rfgt Temp cutout + 2°F. OFF if respective Evap Rfgt Pool Temp rises 4°F above LERTC setting for 1 minute and Chiller Off LERTC Integral = 0. <i>Note: Time period referenced for ON and Off conditions above is dependent on past running conditions and present temperatures measured.</i> ON if entering OR leaving water temperature < LWTC for 30°F-sec (1.11°C-sec) OFF if both entering and leaving water temps rise 2°F above the LWTC setting for 5 minutes.
Freeze Inhibitor	Varies.	<ul style="list-style-type: none"> • Freeze protection can be accomplished by adding sufficient glycol to protect against freezing below the lowest ambient expected. <i>Important: Be sure to apply appropriate LERTC and LWTC control setpoints based on the concentration of the freeze inhibitor or solution freeze point temperature. Note that these settings vary with unit size. See "Low Evaporator Refrigerant Cutout and Glycol Requirements," p. 46.</i> • For units with free-cooling option, glycol solution is REQUIRED. See "Free-Cooling Fluid Management," p. 94. • Use of glycol type antifreeze reduces the cooling capacity of the unit and must be considered in the design of the system specifications.
Drain Water Circuit	Below -4°F	<ul style="list-style-type: none"> • Shut off the power supply to the unit and to all heaters. • Completely drain water from evaporator and exposed water piping not otherwise protected from freezing. See "Water Treatment," p. 31 and "Waterbox Drains and Vents," p. 33. • Blow out the evaporator to ensure no liquid is left in the evaporator and water lines.

NOTICE:

Evaporator Damage!

If insufficient concentration or no glycol is used, the evaporator water flow must be controlled by the UC800 AND heaters must be used to avoid catastrophic damage to the evaporator due to freezing. It is the responsibility of the installing contractor and/or the customer to ensure that a pump will start when called upon by the chiller controls.

Even with water pump control, a power loss of as little as 15 minutes under freezing conditions can damage the evaporator. Only the proper addition of freeze inhibitor or complete drainage of the water circuit can ensure no evaporator damage in the event of a power failure.

By taking the steps outlined above, the RTAF Sintesis chiller should be protected from chilled fluid freezing down to the indicated ambient temperature. In addition, there are general recommendations and application

details that may be considered to reduce the chilled fluid freeze potential. These include:

- Avoid the use of very low or near minimum chilled fluid flow rates through the chiller. Higher velocity chilled fluid flow reduces freeze risk in all situations. Flow rates below published limits have increased freeze potential and have not been considered by freeze protection algorithms.
- Avoid applications and situations that result in a requirement for rapid cycling or repeated starting and stopping of the chiller, especially with ambient temperatures below freezing. Keep in mind that chiller control algorithms may prevent a rapid compressor restart after shutting down when the evaporator has been operating near or below the LERTC limit.
- Maintain refrigerant charge at appropriate levels. If charge is in question, contact Trane service. A reduced or low level of charge can increase the likelihood of freezing conditions in the evaporator and/or LERTC diagnostic shutdowns.



Low Evaporator Refrigerant Cutout and Glycol Requirements

The tables below show the low evaporator temperature cutout for different glycol levels. Additional glycol beyond what is required for freeze protection will adversely effect unit performance. The unit efficiency will be reduced and the saturated evaporator temperature will be reduced. For some operating conditions this effect can be significant.

Always use the applied actual percent glycol to establish the low refrigerant cutout and low water temperature cutout setpoints.

Note: Tables below should not be interpreted as suggesting operating ability or performance characteristics at all tabulated glycol percentages. Full unit simulation is required for proper prediction of unit performance for specific operating conditions. For information on specific conditions, contact Trane product support.

Table 20. Ethylene glycol — low evaporator refrigerant temperature cutout (LERTC) and low water temperature cutout (LWTC)

Unit Sizes 115 to 270 tons				Unit Sizes 280 to 520 tons			
Glycol Percentage (%)	Solution Freeze Point (°F)	Minimum Recommended LERTC (°F)	Minimum Recommended LWTC (°F)	Glycol Percentage (%)	Solution Freeze Point (°F)	Minimum Recommended LERTC (°F)	Minimum Recommended LWTC (°F)
0	32.0	28.6	35.0	0	32.0	32.0	37.0
2	31.0	27.6	34.0	2	31.0	29.5	36.0
4	29.7	26.3	32.7	4	29.7	28.2	34.7
5	29.0	25.6	32.0	5	29.0	27.5	34.0
6	28.3	24.9	31.3	6	28.3	26.8	33.3
8	26.9	23.5	29.9	8	26.9	25.4	31.9
10	25.5	22.1	28.5	10	25.5	24.0	30.5
12	23.9	20.5	26.9	12	23.9	22.4	28.9
14	22.3	18.9	25.3	14	22.3	20.8	27.3
15	21.5	18.1	24.5	15	21.5	20.0	26.5
16	20.6	17.2	23.6	16	20.6	19.1	25.6
18	18.7	15.3	21.7	18	18.7	17.2	23.7
20	16.8	13.4	19.8	20	16.8	15.3	21.8
22	14.7	11.3	17.7	22	14.7	13.2	19.7
24	12.5	9.1	15.5	24	12.5	11.0	17.5
25	11.4	8.0	14.4	25	11.4	9.9	16.4
26	10.2	6.8	13.2	26	10.2	8.7	15.2
28	7.7	4.3	10.7	28	7.7	6.2	12.7
30	5.1	1.7	8.1	30	5.1	3.6	10.1
32	2.3	-1.1	5.3	32	2.3	0.8	7.3
34	-0.7	-4.1	5.0	34	-0.7	-2.2	5.0
35	-2.3	-5.0	5.0	35	-2.3	-3.8	5.0
36	-3.9	-5.0	5.0	36	-3.9	-5.0	5.0
38	-7.3	-5.0	5.0	38	-7.3	-5.0	5.0
40	-10.8	-5.0	5.0	40	-10.8	-5.0	5.0
42	-14.6	-5.0	5.0	42	-14.6	-5.0	5.0
44	-18.6	-5.0	5.0	44	-18.6	-5.0	5.0
45	-20.7	-5.0	5.0	45	-20.7	-5.0	5.0
46	-22.9	-5.0	5.0	46	-22.9	-5.0	5.0
48	-27.3	-5.0	5.0	48	-27.3	-5.0	5.0
50	-32.1	-5.0	5.0	50	-32.1	-5.0	5.0

Table 21. Propylene glycol – low evaporator refrigerant temperature cutout (LERTC) and low water temperature cutout (LWTC)

Unit Sizes 115 to 270 tons				Unit Sizes 280 to 520 tons			
Glycol Percentage (%)	Solution Freeze Point (°F)	Minimum Recommended LERTC (°F)	Minimum Recommended LWTC (°F)	Glycol Percentage (%)	Solution Freeze Point (°F)	Minimum Recommended LERTC (°F)	Minimum Recommended LWTC (°F)
0	32.0	28.6	35.0	0	32.0	32.0	37.0
2	31.0	27.6	34.0	2	31.0	29.5	36.0
4	29.9	26.5	32.9	4	29.9	28.4	34.9
5	29.3	25.9	32.3	5	29.3	27.8	34.3
6	28.7	25.3	31.7	6	28.7	27.2	33.7
8	27.6	24.2	30.6	8	27.6	26.1	32.6
10	26.4	23.0	29.4	10	26.4	24.9	31.4
12	25.1	21.7	28.1	12	25.1	23.6	30.1
14	23.8	20.4	26.8	14	23.8	22.3	28.8
15	23.1	19.7	26.1	15	23.1	21.6	28.1
16	22.4	19.0	25.4	16	22.4	20.9	27.4
18	20.9	17.5	23.9	18	20.9	19.4	25.9
20	19.3	15.9	22.3	20	19.3	17.8	24.3
22	17.6	14.2	20.6	22	17.6	16.1	22.6
24	15.7	12.3	18.7	24	15.7	14.2	20.7
25	14.8	11.4	17.8	25	14.8	13.3	19.8
26	13.8	10.4	16.8	26	13.8	12.3	18.8
28	11.6	8.2	14.6	28	11.6	10.1	16.6
30	9.3	5.9	12.3	30	9.3	7.8	14.3
32	6.8	3.4	9.8	32	6.8	5.3	11.8
34	4.1	0.7	7.1	34	4.1	2.6	9.1
35	2.7	-0.7	5.7	35	2.7	1.2	7.7
36	1.3	-2.1	5.0	36	1.3	-0.2	6.3
38	-1.8	-5.0	5.0	38	-1.8	-3.3	5.0
40	-5.2	-5.0	5.0	40	-5.2	-5.0	5.0
42	-8.8	-5.0	5.0	42	-8.8	-5.0	5.0
44	-12.6	-5.0	5.0	44	-12.6	-5.0	5.0
45	-14.6	-5.0	5.0	45	-14.6	-5.0	5.0
46	-16.7	-5.0	5.0	46	-16.7	-5.0	5.0
48	-21.1	-5.0	5.0	48	-21.1	-5.0	5.0
50	-25.8	-5.0	5.0	50	-25.8	-5.0	5.0



Installation Electrical

General Recommendations

As you review this manual, keep in mind that:

- All field-installed wiring must conform to National Electric Code (NEC) guidelines, and any applicable state and local codes. Be sure to satisfy proper equipment grounding requirements per NEC.
- Compressor motor and unit electrical data (including motor kW, voltage utilization range, rated load amps) is listed on the chiller nameplate.
- All field-installed wiring must be checked for proper terminations, and for possible shorts or grounds.

Note: Always refer to wiring diagrams shipped with chiller or unit submittal for specific electrical schematic and connection information.

⚠ WARNING

Hazardous Voltage w/Capacitors!

Failure to disconnect power and discharge capacitors before servicing could result in death or serious injury. Disconnect all electric power, including remote disconnects and discharge all motor start/run capacitors before servicing. Follow proper lockout/tagout procedures to ensure the power cannot be inadvertently energized. For variable frequency drives or other energy storing components provided by Trane or others, refer to the appropriate manufacturer's literature for allowable waiting periods for discharge of capacitors. Verify with an appropriate voltmeter that all capacitors have discharged.

For additional information regarding the safe discharge of capacitors, see PROD-SVB06*-EN.

⚠ WARNING

Proper Field Wiring and Grounding Required!

Failure to follow code could result in death or serious injury. All field wiring MUST be performed by qualified personnel. Improperly installed and grounded field wiring poses FIRE and ELECTROCUTION hazards. To avoid these hazards, you MUST follow requirements for field wiring installation and grounding as described in NEC and your local/state electrical codes.

NOTICE:

Use Copper Conductors Only!

Failure to use copper conductors could result in equipment damage as unit terminals are not designed to accept other types of conductors.

Important: To prevent control malfunctions, do not run low voltage wiring (<30 V) in conduit with conductors carrying more than 30 volts.

Installer-Supplied Components

Power Supply Wiring

NOTICE:

Use Copper Conductors Only!

Failure to use copper conductors could result in equipment damage as unit terminals are not designed to accept other types of conductors.

Cut holes into the sides of the control panel for the appropriately-sized power wiring conduits. The wiring is passed through these conduits and connected to the terminal blocks or circuit breakers.

To provide proper phasing of 3-phase input, see field wiring drawings for correct wiring. Proper equipment grounds must be provided to each ground connection in the panel.

Control Power Supply

Chiller is provided with control power transformer. It is not necessary to provide additional control power voltage to the unit. No other loads should be connected to the control power transformer.

All units are factory-connected for appropriate labeled voltages.

Heater Power Supply

It is required to provide an independent power source (115V 60Hz, 220V 50Hz) with a fused-disconnect. The heaters are factory wired back to the unit control panel (at terminals 1X6-1 and 1X6-2).

The evaporator shell is insulated from ambient air and protected from freezing for temperatures down to -4°F by shell trace heaters and two thermostatically-controlled immersion heaters, combined with evaporator pump activation through Tracer™ UC800. Whenever the ambient temperature drops below 32°F, the thermostat energizes the heaters and the Tracer UC800 activates the pumps. If ambient temperatures below -4°F are expected, contact your Trane local office.

NOTICE:

Equipment Damage!

Control panel main processor does not verify thermostat operation. A qualified technician must confirm operation of the thermostat to avoid catastrophic damage to the evaporator.

NOTICE:

Equipment Damage!

If evaporator water is drained, evaporator heaters must be disconnected to prevent overheating.

Chilled Water Pump Control

NOTICE:

Evaporator Damage!

If the microprocessor calls for a pump to start and water does not flow, the evaporator may be damaged catastrophically. It is the responsibility of the installing contractor and/or the customer to ensure that a pump will always be running when called upon by the chiller controls.

An evaporator water pump output relay closes when the chiller is given a signal to go into the Auto mode of operation from any source. The contact is opened to turn off the pump in the event of most machine level diagnostics to prevent the build up of pump heat.

The relay output is required to operate the Evaporator Water Pump (EWP) contactor. Contacts should be compatible with 115/240 VAC control circuit. Normally, the EWP relay follows the AUTO mode of the chiller. Whenever the chiller has no diagnostics and is in the AUTO mode, regardless of where the auto command is coming from, the normally open relay is energized. When the chiller exits the AUTO mode, the relay is timed to open in an adjustable 1 to 30 minutes (using Tracer™ TU). The non-AUTO modes in which the pump is stopped, include Reset, Stop, External Stop, Remote Display Stop, Stopped by Tracer, Start Inhibited by Low Ambient Temp, and Ice Building complete.

Table 22. Pump relay operations

Chiller Mode	Relay Operation
Auto	Instant Close
Ice Building	Instant Close
Tracer Override	Timed Open
Stop	Timed Open
Ice Complete	Instant Open
Diagnostics	Instant Open

When going from Stop to Auto, the EWP relay is energized immediately. If evaporator water flow is not established in 20 minutes (for normal transition) or 4 minutes, 15 seconds (for pump commanded ON due to an override safety), the UC800 de-energizes the EWP relay and generates a non-latching diagnostic. If flow returns (e.g. someone else is controlling the pump), the diagnostic is cleared, the EWP is re-energized, and normal control resumed.

If evaporator water flow is lost once it had been established, the EWP relay remains energized and a non-

latching diagnostic is generated. If flow returns, the diagnostic is cleared and the chiller returns to normal operation.

In general, when there is either a non-latching or latching diagnostic, the EWP relay is turned off as though there was a zero time delay. Exceptions whereby the relay continues to be energized occur with:

- **Low Chilled Water Temperature diagnostic** (non-latching unless also accompanied by an Evap Leaving Water Temperature Sensor Diagnostic)
- or
- **Interrupt Failure diagnostic** in which a compressor continues to draw current even after commanded to have shutdown.
- or
- **Loss of Evaporator Water Flow diagnostic** (non-latching) and the unit is in the AUTO mode, after initially having proven evaporator water flow.

Programmable Relays

A programmable relay concept provides for enunciation of certain events or states of the chiller, selected from a list of likely needs, while only using four physical output relays, as shown in the field wiring diagram.

The four relays are provided (generally with a Quad Relay Output LLID) as part of the Programmable Relay Option. The relays contacts are isolated Form C (SPDT), suitable for use with 120 VAC circuits drawing up to 2.8 amps inductive, 7.2 amps resistive, or 1/3 HP and for 240 VAC circuits drawing up to 0.5 amp resistive.

The list of events/states that can be assigned to the programmable relays can be found in the table below. Chiller events/Status description. The relay will be energized when the event/state occurs.

Table 23. Alarm and status relay output configuration

	Description
Alarm - Latching	This output is true whenever there is any active latching shutdown diagnostic that targets the Unit, Circuit, or any of the Compressors on a circuit.
Alarm - NonLatching	This output is true whenever there is any active non-latching shutdown diagnostic that targets the Unit, Circuit, or any of the Compressors on a circuit.
Alarm	This output is true whenever there is any active latching or non-latching shutdown diagnostic that targets the Unit, Circuit, or any of the Compressors on a circuit.
Alarm Ckt 1	This output is true whenever there is any active latching or non-latching shutdown diagnostic that targets Circuit 1, or any of the Compressors on Circuit 1.
Alarm Ckt 2	This output is true whenever there is any active latching or non-latching shutdown diagnostic that targets Circuit 2, or any of the Compressors on Circuit 2.



Installation Electrical

Table 23. Alarm and status relay output configuration (continued)

	Description
Unit Limit Mode	This output is true whenever a circuit on the unit has been running in one of the limit modes continuously for the Limit Relay debounce time. A given limit or overlapping of different limits must be in effect continuously for the debounce time prior to the output becoming true. It will become false if no limits are present for the debounce time.
Compressor Running	The output is true whenever any compressor is running.
Circuit 1 Running	The output is true whenever any compressor of Circuit 1 is running.
Circuit 2 Running	The output is true whenever any compressor of Circuit 2 is running.
Ice Building	This output is true when Ice Building status is active.
Maximum Capacity	The output is true whenever the unit has reached maximum capacity continuously for the Max Capacity Relay s time. The output is false when the unit is not at maximum capacity continuously for the filter time.
Evaporator Water Freeze Avoidance Request	This relay output is energized any time either the Low Evaporator Water Temperature – Unit Off or the Low Evaporator Temperature Ckt x – Unit Off diagnostics are active. This relay is intended for use as an external interlock for a field engineered and provided solution to mitigate the freeze danger implied by these diagnostics. Generally, this would be used in cases where operation of the evaporator water pump is unacceptable due to the system constraints, (i.e. such as mixing unconditioned warm water with controlled supply water as provided by other parallel chillers. The relay's output can provide the method to close bypass valves so the circulation becomes local to the evap and excludes the load, or can be used to defeat the evap pump override entirely while initiating an independent source of heat / flow to the evap.
None:	This selection is desirable to provide an easy way for a customer to defeat the effect of the relay, if it has already been wired. For instance, if the relay was normally programmed as an "alarm" relay, and was wired to a claxon, it may be desirable to temporarily defeat the feature without changing wiring.
Service request (for Unit, Compressor(s) or water pump):	This relay will be energized when at least one Maintenance alert condition (refer to Service required message specification) occurs, as long as at least one of associated informational diagnostic(s) will be active.

Relay Assignments Using Tracer TU

Tracer™ TU Service Tool is used to install the Programmable Relay Option package and assign any of the above lists of events or status to each of the four relays provided with the option. The relays to be programmed are referred to by the relay's terminal numbers on the LLID board 1K23.

The default assignments for the four available relays of the Programmable Relay option are:

Table 24. Default assignments - module 1

Relay	Output	Default
Relay 1	Terminals J2-1, 2, 3	Evaporator Water Freeze Avoidance Request
Relay 2	Terminals J2-4, 5, 6	Maximum Capacity
Relay 3	Terminals J2-7, 8, 9	Compressor Running
Relay 4	Terminals J2-10, 11, 12	Latching Alarm

Table 25. Default assignments - module 2 (if present)

Relay	Output	Default
Relay 5	Terminals J2-1, 2, 3	Alarm Ckt2
Relay 6	Terminals J2-4, 5, 6	Alarm Ckt1
Relay 7	Terminals J2-7, 8, 9	Alarm (Latching or Non-Latching)
Relay 8	Terminals J2-10, 11, 12	Non-Latching Alarm

If any of the Alarm/Status relays are used, provide electrical power, 115 VAC with fused-disconnect to the panel and wire through the appropriate relays (terminals on 1A10). Provide wiring (switched hot, neutral, and ground connections) to the remote annunciation devices. Do not use power from the chiller's control panel transformer to power these remote devices. See the field diagrams which are shipped with the unit.

Low Voltage Wiring

The remote devices described below require low voltage wiring. All wiring to and from these remote input devices to the Control Panel must be made with shielded, twisted pair conductors. Be sure to ground the shielding only at the panel.

Important: *To prevent control malfunctions, do not run low voltage wiring (<30 V) in conduit with conductors carrying more than 30 volts.*

Emergency Stop

UC800 provides auxiliary control for a customer specified/ installed latching trip out. When this customer-furnished remote contact 6S2 is provided, the chiller will run normally when the contact is closed. When the contact opens, the unit will trip on a manually resettable diagnostic. This condition requires manual reset at the front of the control panel.

Connect low voltage leads to terminal strip locations on 1K2. Refer to the field diagrams that are shipped with the unit.

Silver or gold-plated contacts are recommended. These customer-furnished contacts must be compatible with 24 VDC, 12 mA resistive load.

External Auto/Stop

If the unit requires the external Auto/Stop function, the installer must provide remote contact 6S1.

The chiller will run normally when the contacts are closed. When either contact opens, the compressor(s), if operating, will go to the RUN:UNLOAD operating mode and cycle off. Unit operation will be inhibited. Closure of the contacts will permit the unit to return to normal operation.

Field-supplied contacts for all low voltage connections must be compatible with dry circuit 24 VDC for a 12 mA resistive load. Refer to the field diagrams that are shipped with the unit.

Ice Building Option

UC800 provides auxiliary control for a customer specified/ installed contact closure for ice building if so configured and enabled. This output is known as the Ice Building Status Relay. The normally open contact will be closed when ice building is in progress and open when ice building has been normally terminated either through Ice Termination setpoint being reached or removal of the Ice Building command. This output is for use with the ice storage system equipment or controls (provided by others) to signal the system changes required as the chiller mode changes from "ice building" to "ice complete". When contact 5K3 is provided, the chiller will run normally when the contact is open.

UC800 will accept either an isolated contact closure (External Ice Building command) or a Remote Communicated input (Tracer) to initiate and command the Ice Building mode.

UC800 also provides a "Front Panel Ice Termination Setpoint", settable through Tracer[®] TU, and adjustable from 20 to 31°F (-6.7 to -0.5°C) in at least 1°F (1°C) increments.

Note: *When in the Ice Building mode, and the evaporator entering water temperature drops below the ice termination setpoint, the chiller terminates the Ice Building mode and changes to the Ice Building Complete Mode.*

NOTICE:

Equipment Damage!

Freeze inhibitor must be adequate for the leaving water temperature. Failure to do so will result in damage to system components.

Tracer[™] TU must also be used to enable or disable Ice Machine Control. This setting does not prevent the Tracer from commanding Ice Building mode.

Upon contact closure, the UC800 will initiate an ice building mode, in which the unit runs fully loaded at all times. Ice building shall be terminated either by opening the contact or based on the entering evaporator water

temperature. UC800 will not permit the ice building mode to be reentered until the unit has been switched out of ice building mode (open 5K3 contacts) and then switched back into ice building mode (close 5K3 contacts.)

In ice building, all limits (freeze avoidance, evaporator, condenser, current) will be ignored. All safeties will be enforced.

If, while in ice building mode, the unit gets down to the freeze stat setting (water or refrigerant), the unit will shut down on a manually resettable diagnostic, just as in normal operation.

Connect leads from 5K3 to the proper terminals of 1K22. See the field diagrams which are shipped with the unit.

Silver or gold-plated contacts are recommended. These customer furnished contacts must be compatible with 24 Vdc, 12 mA resistive load.

External Chilled Water Setpoint (ECWS) Option

The UC800 provides inputs that accept either 4-20 mA or 2-10 VDC signals to set the external chilled water setpoint (ECWS). This is not a reset function. The input defines the setpoint. This input is primarily used with generic BAS (building automation systems). The chilled water setpoint is set via the Tracer[®] AdaptiView[™] TD7 or through digital communication with Tracer (Comm3).

The chilled water setpoint may be changed from a remote location by sending either a 2-10 VDC or 4-20 mA signal to the 1K24, terminals 2 and 3 LLID. The 2-10 VDC and 4-20 mA each correspond to a 10 to 65°F (-12 to 18°C) external chilled water setpoint.

The following relationships exist:

Voltage Signal	External Water Setpoint
< 1 VDC	Invalid
1 VDC to 2 VDC	min
2 VDC to 10 VDC	$\text{min} + (\text{max}-\text{min}) * (\text{Signal}-2)/8$
10 VDC to 11 VDC	max
> 11 VDC	Invalid
Current Signal	External Water Setpoint
< 2 mA	Invalid
2 mA to 4 mA	min
4 ma to 20 mA	$\text{min} + (\text{max}-\text{min}) * (\text{Signal}-4)/16$
20 mA to 22 mA	max
>22 mA	Invalid

If the ECWS input develops an open or short, the LLID will report either a very high or very low value back to the main processor. This will generate an informational diagnostic and the unit will default to using the Front Panel (TD7) Chilled Water Setpoint.

Tracer TU Service Tool is used to set the input signal type from the factory default of 2-10 VDC to that of 4-20 mA. Tracer TU is also used to install or remove the External

Chilled Water Setpoint option as well as a means to enable and disable ECWS.

External Demand Limit Setpoint (EDLS) Option

Similar to the above, the UC800 also provides for an optional External Demand Limit Setpoint that will accept either a 2-10 VDC (default) or a 4-20 mA signal. The Demand Limit Setting can also be set via the Tracer AdaptiView™ TD7 or through digital communication with Tracer (Comm 3). The arbitration of the various sources of demand limit is described in the flow charts at the end of this section. The External Demand Limit Setpoint may be changed from a remote location by hooking up the analog input signal to the 1K24 LLID terminals 5 and 6. Refer to the following paragraph on Analog Input Signal Wiring Details. The following equations apply for EDLS:

	Voltage Signal	Current Signal
As generated from external source	$VDC + 0.133 * (\%) - 6.0$	$mA = 0.266 * (\%) - 12.0$
As processed by UCM	$\% = 7.5 * (VDC) + 45.0$	$\% = 3.75 * (mA) + 45.0$

If the EDLS input develops an open or short, the LLID will report either a very high or very low value back to the man processor. This will generate an informational diagnostic and the unit will default to using the Front Panel (Tracer AdaptiView™ TD7) Current Limit Setpoint.

The Tracer™ TU Service Tool must be used to set the input signal type from the factory default of 2-10 VDC to that of 4-20 mA current. Tracer TU must also be used to install or remove the External Demand Limit Setpoint Option for field installation, or can be used to enable or disable the feature (if installed).

EDLS and ECWS Analog Input Signal Wiring Details:

Both the ECWS and EDLS can be connected and setup as either a 2-10 VDC (factory default), 4-20 mA, or resistance input (also a form of 4-20mA) as indicated below. Depending on the type to be used, the Tracer TU Service Tool must be used to configure the LLID and the MP for the proper input type that is being used. This is accomplished by a setting change on the Custom Tab of the Configuration View within Tracer TU.

Important: For proper unit operation, BOTH the EDLS and ECWS settings MUST be the same (2-10 VDC or 4-20mA), even if only one input is to be used.

The J2-3 and J2-6 terminal is chassis grounded and terminal J2- 1 and J2-4 can be used to source 12 VDC. The ECLS uses terminals J2-2 and J2-3. ECWS uses terminals J2-5 and J2-6. Both inputs are only compatible with high-side current sources.

Figure 35. Wiring examples for EDLS and ECWS

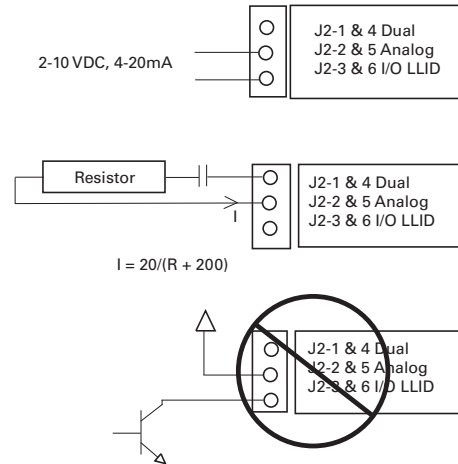

Chilled Water Reset (CWR)

UC800 resets the chilled water temperature set point based on either return water temperature, or outdoor air temperature. Return Reset is standard, Outdoor Reset is optional.

The following shall be selectable:

- One of three Reset Types: None, Return Water Temperature Reset, Outdoor Air Temperature Reset, or Constant Return Water Temperature Reset.
- Reset Ratio Set Points.
For outdoor air temperature reset there shall be both positive and negative reset ratio's.
- Start Reset Set Points.
- Maximum Reset Set Points.

The equations for each type of reset are as follows:

Return

$$CWS' = CWS + \text{RATIO} (\text{START RESET} - (TWE - TWL))$$

$$\text{and } CWS' > \text{ or } = CWS$$

$$\text{and } CWS' - CWS < \text{ or } = \text{Maximum Reset}$$

Outdoor

$$CWS' = CWS + \text{RATIO} * (\text{START RESET} - \text{TOD})$$

$$\text{and } CWS' > \text{ or } = CWS$$

$$\text{and } CWS' - CWS < \text{ or } = \text{Maximum Reset}$$

where

CWS' is the new chilled water set point or the "reset CWS"

CWS is the active chilled water set point before any reset has occurred, e.g. normally Front Panel, Tracer, or ECWS

RESET RATIO is a user adjustable gain

START RESET is a user adjustable reference

TOD is the outdoor temperature

TWE is entering evap. water temperature

TWL is leaving evap. water temperature

MAXIMUM RESET is a user adjustable limit providing the maximum amount of reset. For all types of reset, $CWS' - CWS < \text{or} = \text{Maximum Reset}$.

Range		Increment				
Reset Type	Reset Ratio	Start Reset	Max Reset	IP Units	SI Units	Factory Default
Return	10 to 120%	4 to 30 F	0 to 20 F	1%	1%	50%
		(2.2 to 16.7 C)	(0.0 to 11.1 C)			
Outdoor	80 to -80%	50 to 130 F	0 to 20 F	1%	1%	10%
		(10 to 54.4 C)	(0.0 to 11.1 C)			

In addition to Return and Outdoor Reset, the MP provides a menu item for the operator to select a Constant Return Reset. Constant Return Reset will reset the leaving water temperature set point so as to provide a constant entering water temperature. The Constant Return Reset equation is the same as the Return Reset equation except on selection of Constant Return Reset, the MP will automatically set Ratio, Start Reset, and Maximum Reset to the following.

$$\text{RATIO} = 100\%$$

$$\text{START RESET} = \text{Design Delta Temp.}$$

$$\text{MAXIMUM RESET} = \text{Design Delta Temp.}$$

The equation for Constant Return is then as follows:

$$CWS' = CWS + 100\% (\text{Design Delta Temp.} - (TWE - TWL))$$

and $CWS' > \text{or} = CWS$

$$\text{and } CWS' - CWS < \text{or} = \text{Maximum Reset}$$

When any type of CWR is enabled, the MP will step the Active CWS toward the desired CWS' (based on the above equations and setup parameters) at a rate of 1 degree F every 5 minutes until the Active CWS equals the desired CWS'. This applies when the chiller is running.

When the chiller is not running, CWS is reset immediately (within one minute) for Return Reset and at a rate of 1 degree F every 5 minutes for Outdoor Reset. The chiller will start at the Differential to Start value above a fully reset CWS or CWS' for both Return and Outdoor Reset.

AFD Drive

Trane TR200 drive is an electronic motor controller that converts AC mains input into a variable AC waveform output. The frequency and voltage of the output are regulated to control the motor speed or torque.

TR200 drive includes the following features:

- Soft start to minimize inrush current
- Improved harmonic mitigation with DC link reactor
- Integrated power fuse
- Graphical LCD keypad
- Unit Mounted with factory pre-wiring
- 'Trane Drive Utility' for configuration and tracking

See Service Manual BAS-SVM01*-EN for more information.

AFD Drive Installation

The AFD drive is manufactured with a jumper installed between terminal 12 (+24Vdc source) and terminal 37 (Safe Stop digital input). This jumper must be removed prior to unit operation. See figure below for view of jumper as it would be installed on drive from manufacturer.

NOTICE:

Equipment Damage!

Verify/remove jumper between AFD terminals 12 and 37 before unit operation. Failure to remove jumper could cause equipment damage.

Figure 36. AFD jumper



Jumper between terminals 12 and 37 must be removed prior to unit operation.



Installation Electrical

AFD Drive Programming

Field replacement drives must be programmed via the keypad interface. Program parameters sequentially by ID values as defined in tables below.

Table 26. Non-compressor specific parameter settings

ID	Description	Setting
0-03	Region Settings	[1] North American
0-20	Display Line 1.1 Small	[1612] Motor Voltage
0-24	Display Line 3 Large	[1617] Speed (rpm)
0-40	[Hand on] Key on LCP	[0] Disabled
0-41	[Off] Key on LCP	[0] Disabled
0-60	Main Menu Password	999
0-61	Access to Main Menu w/o Password	[1] LCP: Read-only
1-03	Torque Characteristics	[0] Compressor Torque
1-21	Motor Power [HP]	See table below ^(a)
1-22	Motor Voltage	See table below ^(a)
1-23	Motor Frequency	60Hz
1-24	Motor Current	See table below ^(a)
1-25	Motor Nominal Speed	See table below ^(a)
1-71	Start Delay	0s
1-73	Flying Start	[0] Disabled
1-78	Compressor Start Max Speed [Hz]	30Hz
1-79	Compressor Start Max Time to Trip	10s
1-82	Min Speed for Function at Stop [Hz]	10Hz
1-87	Trip Speed Low [Hz]	25Hz
3-02	Minimum Reference	30Hz
3-03 ^(b)	Minimum Reference	See Table 28
3-41	Ramp 1 Ramp Up Time	5s
3-42	Ramp 1 Ramp Down Time	5s
3-82	Starting Ramp Up Time	3s
4-10	Motor Speed Direction	[0] Clockwise
4-12	Motor Speed Low Limit [Hz]	30Hz
4-18	Current Limit	128.4%

Table 26. Non-compressor specific parameter settings (continued)

ID	Description	Setting
4-19	Max Output Frequency	See table below ^(a)
4-14 ^(b)	Motor Speed High Limit [Hz]	See Table 28
5-12	Terminal 27 Digital Input	[2] Coast Inverse
5-13	Terminal 29 Digital Input	[0] No Operation
5-40.0	Function Relay 1	[5] Running
5-40.1	Function Relay 2	[3] Drive Rdy/Rem Ctrl
5-41.0	On Delay, Relay 1	1s
5-41.1	On Delay, Relay 2	1s
5-42.0	Off Delay, Relay 1	1s
5-42.1	Off Delay, Relay 2	1s
6-10	Terminal 53 Low Voltage	2V
6-14	Terminal 53 Low Ref./Feedb. Value	30Hz
6-15 ^(b)	Terminal 53 High Ref./Feedb. Value	See Table 28
6-50	Terminal 42 Output	[133] Motor Cur. 4-20mA
14-03	Overmodulation	[0] Off
14-10	Mains Failure	[4] Kinetic Back-up
14-11	Mains Voltage at Mains Fault	See table below ^(a)
14-20	Reset Mode	[1] Automatic Reset x 1
14-30	Current Lim Ctrl. Proportional Gain	25%
14-31	Current Lim Ctrl. Integration Time	1s
14-50	RFI Filter	[0] Off
14-51	DC Link Compensation	[1] On
22-75	Short Cycle Protection	[1] Enabled
22-76	Interval Between Starts	60s

(a) For unit sizes 115 to 215, see Table 27. For unit sizes 230 to 520 tons, see Table 28.

(b) Parameter for 230 to 520 ton units only.

Table 27. Compressor-specific parameter settings, 115 to 215 tons – 60Hz^(a)

Parameters		L1			L2			M3			M4			N3		
ID	Description	460V	380V	575V	460V	380V	575V	460V	380V	575V	460V	380V	575V	460V	380V	575V
1-21	Motor Power (hp)	86	86	86	102	102	102	122	122	122	144	144	144	177	177	177
1-22	Motor Voltage (V)	460V	380V	575V	460V	380V	575V	460V	380V	575V	460V	380V	575V	460V	380V	575V
1-24	Motor Current (A)	91A	110A	73A	109A	132A	87A	128A	154A	101A	151A	182A	120A	183A	221A	146A
1-25	Motor Nominal Speed (rpm)	3461	3460	3461	3459	3466	3461	3502	3505	3503	3494	3494	3494	3494	3495	3493
4-19	Max Output Frequency (Hz)	61	61	61	61	61	61	61	61	61	61	61	61	61	61	61
14-11	Voltage at Main Fault (V)	391V	323V	489V	391V	323V	489V	391V	323V	489V	391V	323V	489V	391V	323V	489V

(a) 400V/50 Hz units use 380V/60Hz compressor settings.

Table 28. Compressor-specific parameter settings, 230 to 500 tons – 60Hz^(a)

Parameters		M3			N5			N6			N6E2
ID	Description	460V	380V	575V	460V	380V	575V	460V	380V	575V	460V
1-21	Motor Power (hp)	122	122	122	177	177	177	209	209	209	215
1-22	Motor Voltage (V)	460	380	575	460	380	575	460	380	575	380
1-24	Motor Current (A)	128	154	101	183	221	146	220	266	175	274
1-25	Motor Nominal Speed (rpm)	3502	3505	3503	3494	3495	3495	3466	3468	3468	3462
3-03	Maximum Reference (Hz)	60	60	60	60	60	60	60	60	60	70
4-19	Max Output Frequency (Hz)	61	61	61	61	61	61	61	61	61	71
4-14	Motor Speed High Lim (Hz)	60	60	60	60	60	60	60	60	60	70
6-15	Term 53 High Ref Val (Hz)	60	60	60	60	60	60	60	60	60	70
14-11	Voltage at Main Fault (V)	391	323	489	391	323	489	391	323	489	391

(a) 400V/50Hz units use 380V/60Hz compressor settings.

Communication Interfaces

LonTalk Interface (LCI-C)

UC800 provides an optional LonTalk[®] Communication Interface (LCI-C) between the chiller and a Building Automation System (BAS). An LCI-C LLID shall be used to provide “gateway” functionality between a LonTalk compatible device and the Chiller. The inputs/outputs include both mandatory and optional network variables as established by the LONMARK[®] Functional Chiller Profile 8040.

Note: For more information see ACC-SVN100*-EN.

BACnet Interface (BCI-C)

Optional BACnet[®] Communication Interface for Chillers (BCI-C) is comprised of a Tracer UC800 controller with interface software. It is a non-programmable communications module that allows units to communicate on a BACnet communications network.

Note: For more information, see BAS-SVP01*-EN.

Modbus Remote Terminal Unit Interface

Modicon Communication Bus (Modbus[™]) enables the chiller controller to communicate as a slave device on a Modbus network. Chiller setpoints, operating modes, alarms and status can be monitored and controlled by a Modbus master device.

Note: For more information, see BAS-SVP01*-EN.



Operating Principles

Refrigerant Circuit

Each unit has two refrigerant circuits, with one or two rotary screw compressors per circuit. Each refrigerant circuit includes compressor suction and discharge service valves, liquid line shut off valve, removable core liquid line filter, liquid line sight glass, charging port, pressure relief valves on both high and low side of system, and electronic expansion valve. Fully modulating compressor and electronic expansion valve provide variable capacity modulation over the entire operating range.

Refrigerant Cycle

Typical refrigerant cycle is represented on the pressure enthalpy diagram shown in the figure below. Key state points are indicated on the figure. The cycle for the full load design point is represented in the plot.

Figure 37. Pressure-enthalpy diagram

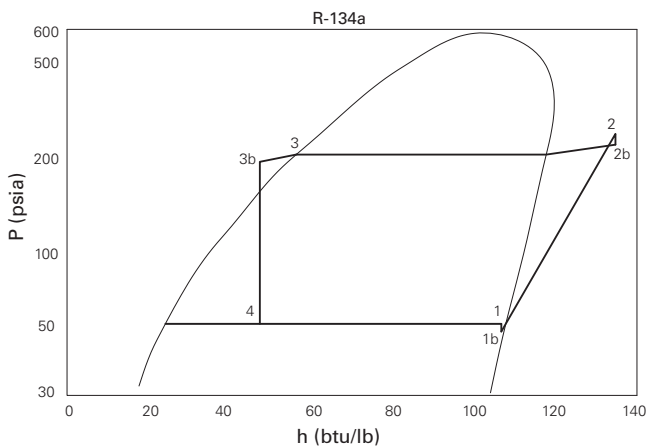

The chiller uses a shell and tube evaporator design with refrigerant evaporating on the shell side and water flowing inside tubes having enhanced surfaces (states 4 to 1). The suction lines are designed to minimize pressure drop (states 1 to 1b) the compressor is a twin-rotor helical rotary compressor designed similarly to the compressors offered in other Trane screw compressor based chiller (states 1b to 2). The discharge lines include a highly efficient oil separation system that removes 99.8% of the oil from the refrigerant stream going to the heat exchangers (states 2 to 2b). De-superheating, condensing and sub-cooling are accomplished in a microchannel air-air-cooled heat exchanger where refrigerant is condensed inside the microchannel (states 2b to 3b). Refrigerant flow through the system is balanced by an electronic expansion valve (states 3b to 4).

Refrigerant and Oil

Use only R-134a or R-513A as shown on unit nameplate, and selected in unit model number digit 16.

Digit 16 = 1 or 3: R-513A

Digit 16 = 2 or 4: R-134a

The Sintesis™ chiller uses environmentally friendly refrigerants. Trane believes that responsible refrigerant practices are important to the environment, our customers, and the air conditioning industry. All technicians who handle refrigerants must be certified. The Federal Clean Air Act (Section 608) sets forth the requirements for handling, reclaiming, recovering and recycling of certain refrigerants and the equipment that is used in these service procedures. In addition, some states or municipalities may have additional requirements that must also be adhered to for responsible management of refrigerants. Know the applicable laws and follow them.

R-134a and R-513A are medium pressure refrigerants. They may not be used in any condition that would cause the chiller to operate in a vacuum without a purge system. Sintesis is not equipped with a purge system. Therefore, the chiller may not be operated in a condition that would result in a saturated refrigerant condition in the chiller of -15°F (-26°C) or lower.

Use only the specific POE oil as designated on the unit nameplate.

Compressor and Lube Oil System

The rotary screw compressor is semi-hermetic, direct drive, with rolling element bearings and oil heater. The motor is a suction gas cooled, hermetically sealed, two-pole squirrel cage induction motor.

An adaptive frequency drive provides capacity control of the lead compressor on each circuit. For maximum efficiency, larger tonnage units utilize both fixed speed and variable speed compressors staged in the same circuit. Proven Trane controls manage the staging and loading of the fixed and variable speed compressors for maximum unit efficiency and stability.

Oil separator is provided separate from the compressor. Oil filtration is provided internal to the compressor. Check valves in the compressor discharge and lube oil system are also provided.

Condenser and Fans

See Figure 3, p. 11 for condenser fan designator locations.

The air-cooled microchannel condenser coils use all aluminum brazed fin construction. The condenser coil has an integral subcooling circuit. The maximum allowable working pressure of the condenser is 350 psig.

Condensers are factory proof and leak tested at 525 psig. Coils can be cleaned with water.

Direct-drive vertical-discharge airfoil condenser fans are dynamically balanced. The condenser fan motors are permanent magnet motors with integrated drive to provide variable speed fan control for all fans.

All condenser fan motors are designed with permanently lubricated ball bearings and internal temperature and current overload protection.

Evaporator

The evaporator is a tube-in-shell heat exchanger design constructed from carbon steel shells and tubesheets with internally and externally finned seamless copper tubes mechanically expanded into the tube sheets. The evaporator is designed, tested and stamped in accordance with the ASME Boiler and Pressure Vessel Code for a refrigerant side working pressure of 200 psig. The evaporator is designed for a water side working pressure of 150 psig.

Note: When free-cooling option is selected, waterside working pressure is 90 psig.

Standard water connections are grooved for Victaulic style pipe couplings, with flange style connections optionally available. Waterboxes are provided in a 2 pass configuration on units up to 270 tons. Evaporators for 280 to 520 ton units utilize a 1-pass configuration. Each waterbox includes a vent, drain and fittings for temperature control sensors. A factory installed flow switch is installed on the supply waterbox in the evaporator inlet connection.

Evaporators are insulated with 3/4 in closed cell insulation.

Evaporator shell heaters and waterbox heaters with thermostat are provided to help protect the evaporator from freezing at ambient temperatures down to -4°F (-20°C).

Note: A separate field supplied 120V power source is required to power the evaporator freeze protection. See “[Installer-Supplied Components](#),” p. 48 and “[Freeze Avoidance](#),” p. 45 for more information.

Refrigerant Management

Refrigerant management system varies by unit size.

- Unit sizes 115 to 215 tons with design sequence AE and earlier use an actuated suction valve.
- Unit sizes 230 to 520 tons, and sizes 115 to 215 tons and design sequence AF and later, utilize a receiver tank.

Free-Cooling — Operating Modes

The advantage of optional chiller integrated free-cooling is the ability to utilize outdoor air temperatures to assist in making chilled water when appropriate. The unit controls direct flow through or around the free-cooling coils to optimize chiller efficiency. Determining the operating mode depends on four temperatures:

- Ambient air temperature
- Evaporator entering fluid temperature
- Evaporator leaving fluid temperature
- Chilled water set point

Mechanical Cooling Mode

In this operating mode, ambient temperature is the same or higher than the temperature of the fluid entering the evaporator. Free-cooling coils are bypassed, compressors are running, and the controls modulate compressors and fans to meet cooling load at optimum efficiency.

Combined Mechanical and Free-Cooling Mode

If the ambient temperature is below the evaporator entering fluid temperature, and free-cooling only cannot satisfy the load, the controls modulate compressors and fans to meet the remaining cooling load at optimum efficiency. Fluid will continue to flow through free-cooling coils, reducing the evaporator entering fluid temperature.

Note: Depending on load, one or both circuits may engage mechanical cooling.

Free-Cooling Only Mode

In this operating mode, free-cooling is enabled and capable of meeting the cooling load without the need for mechanical cooling. As ambient falls below the temperature at which full load capacity is provided by free-cooling only (or the load drops), fan control modulates fan speed down to a minimum of 15%. If ambient (or load) continues to drop, valve control provides modulation between free-cooling coils.

Table 29. Free-cooling operation

Component	Mechanical Cooling	Combined Mechanical and Free-Cooling	Free-Cooling Only	
			Fan Control	Valve Control
Ambient Air	Greater Than Fluid	Less Than Fluid	Less Than Fluid	Less Than Fluid
Compressors	On — Modulating	On — Modulating	Off	Off
Fans	On — Modulating	On — Modulating	Modulating	15%
Free-Cooling Coil Flow	Off	100%	100%	Modulating



Controls

Overview

Sintesis™ RTAF chillers utilize the following control/ interface components:

- Tracer™ UC800 Controller
- Tracer AdaptiView™ TD7 Operator Interface

UC800 Specifications

This section covers information pertaining to the UC800 controller hardware.

Wiring and Port Descriptions

Figure below illustrates the UC800 controller ports, LEDs, rotary switches, and wiring terminals. The numbered list below the figure corresponds to the numbered callouts in the illustration.

Figure 38. Wiring locations and connection ports

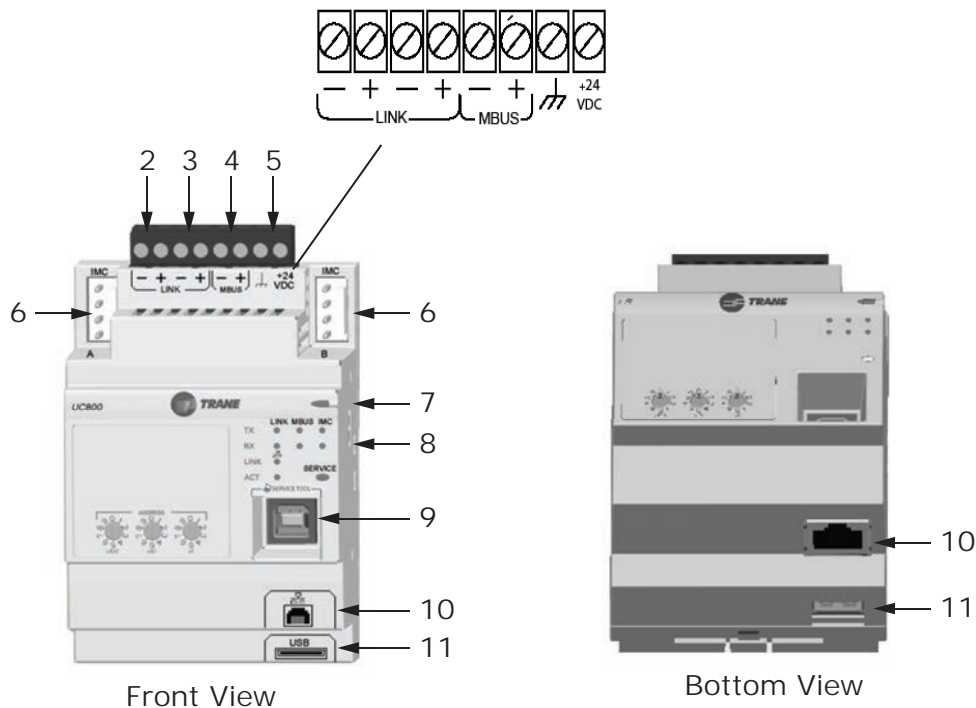

1. Rotary Switches for setting BACnet® MAC address or MODBUS ID.
2. LINK for BACnet MS/TP, or MODBUS Slave (two terminals, ±). Field wired if used.
3. LINK for BACnet MS/TP, or MODBUS Slave (two terminals, ±). Field wired if used.
4. Machine bus for existing machine LLIDs (IPC3 Tracer bus 19.200 baud). *IPC3 Bus: used for Comm4 using TCI or LonTalk® using LCI-C.*
5. Power (210 mA at 24 Vdc) and ground terminations (same bus as item 4). Factory wired.
6. Not used.
7. Marquee LED power and UC800 Status indicator (Table 30, p. 59).
8. Status LEDs for the BAS link, MBus link, and IMC link.
9. USB device type B connection for the service tool (Tracer TU).
10. The Ethernet connection can *only* be used with the Tracer AdaptiView display.
11. USB Host (not used).

Communication Interfaces

There are four connections on the UC800 that support the communication interfaces listed. See [Figure 38, p. 58](#) for the locations of each of these ports.

- BACnet[®] MS/TP
- MODBUS[™] Slave
- LonTalk[™] using LCI-C (from the IPC3 bus)
- Comm 4 using TCI (from the IPC3 bus)

Rotary Switches

There are three rotary switches on the front of the UC800 controller. Use these switches to define a three-digit address when the UC800 is installed in a BACnet or MODBUS system (e.g., 107, 127, etc.).

Note: Valid addresses are 001 to 127 for BACnet and 001 to 247 for MODBUS.

LED Description and Operation

There are 10 LEDs on the front of the UC800. Figure below shows the locations of each LED and [Table 30](#) describes their behavior in specific instances.

Figure 39. LED locations

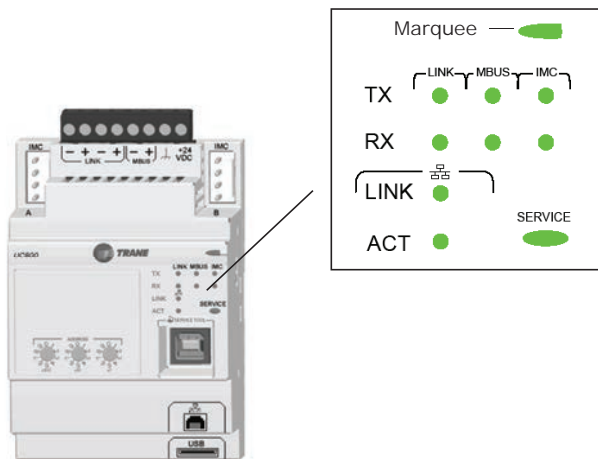

Table 30. LED behavior

LED	UC800 Status
Marquee LED	Powered. If the Marquee LED is green solid, the UC800 is powered and no problems exist.
	Low power or malfunction. If the Marquee LED is red solid, the UC800 is powered, but there are problems present.
	Alarm. The Marquee LED blinks Red when an alarm exists.
LINK, MBUS, IMC	The TX LED blinks green at the data transfer rate when the UC800 transfers data to other devices on the link.
	The Rx LED blinks yellow at the data transfer rate when the UC800 receives data from other devices on the link.
Ethernet Link	The LINK LED is solid green if the Ethernet link is connected and communicating. The ACT LED blinks yellow at the data transfer rate when data flow is active on the link.
Service	The Service LED is solid green when pressed. For qualified service technicians only. Do not use.

Important: Maintain at least 6 inches between low-voltage (<30V) and high voltage circuits. Failure to do so could result in electrical noise that could distort the signals carried by the low-voltage wiring, including IPC.

Tracer AdaptiView TD7 Display

Operator Interface

Information is tailored to operators, service technicians, and owners. When operating a chiller, there is specific information you need on a day-to-day basis—setpoints, limits, diagnostic information, and reports. Day-to-day operational information is presented at the display. Logically organized groups of information—chiller modes of operation, active diagnostics, settings and reports put information conveniently at your fingertips.

Figure 40. TD7 screens



Operator Display Boot Screen



Display Loading Data



Home Screen, Auto Mode

Home Screen

The home screen (shown below) provides the most frequently needed chiller status information on “touch targets” (the entire white rectangular areas) for each chiller component. Touching any touch target displays a screen containing more chiller status information related to each component.

Figure 41. Home screen



Table 31. Home screen items

Description	Resolution	Units
Top Level Mode Ckt1		
Top Level Mode Ckt 2		
Outdoor Air Temperature	XXX.X	°F /°C
Percent Air Flow Ckt1/Ckt2	XXX.X/XXX.X	%
Active Chilled Water Setpoint	XXX.X	°F /°C
Chiller Load Command	X.X	%
Evaporator Water Flow Status	Flow/No Flow	
Evap Entering/Leaving Water Temp	XXX.X/XXX.X	°F /°C

Viewing Operating Modes

On the Reports screen, touch Operating Modes to view the current operating status of the chiller in terms of the top-level operating mode and submodes.

Note: You can also access the Chiller Operating Modes screen from the chiller status button in the upper left corner of the screen.

Figure 42. Chiller operating modes

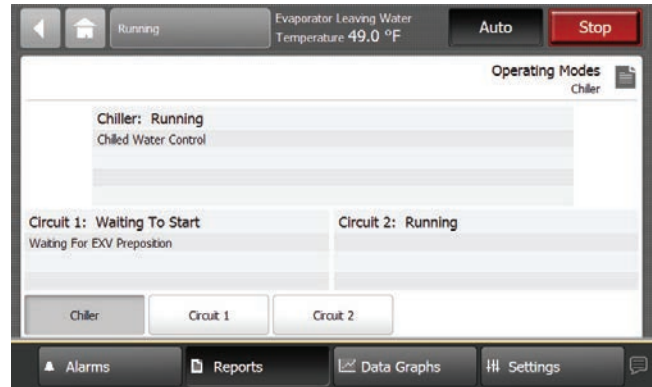

Touch Circuit 1 or Circuit 2 on Operating Modes screen to view circuit and compressor modes and submodes.

Figure 43. Circuit operating modes

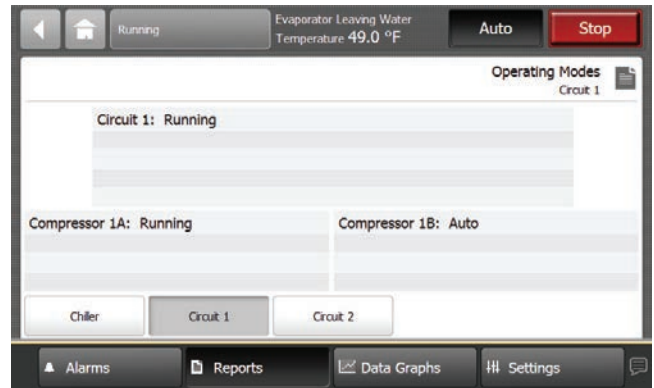

Table 32. Operating modes – chiller

Chiller Modes	Description
MP Resetting	The main processor is going through reset
	No chiller sub-modes.
Stopped	The chiller is not running either circuit and cannot run without intervention. Further information is provided by the sub-mode:
Local Stop	Chiller is stopped by TD7 Stop button command– cannot be remotely overridden.
Immediate Stop	Chiller is stopped by the TD7 Panic Stop (by pressing Stop then Immediate Shutdown in succession) – previous shutdown was manually commanded to shutdown immediately.
No Circuits Available	The entire chiller is stopped by circuit diagnostics or lockouts that may automatically clear.
Diagnostic Shutdown – Manual Reset	The chiller has been shut down on a latching diagnostic that requires manual intervention to reset.
Chilled Water Control	Chiller is running to provide a chilled water temperature per the active chilled water setpoint (may be as arbitrated from various sources). (For cooling only units, this mode may be suppressed.)

Table 32. Operating modes – chiller (continued)

Chiller Modes	Description
Starting is Inhibited by Low Ambient Temperature	The chiller is inhibited based on the outdoor air temperature.
Starting is Inhibited by External Source	The chiller is inhibited from starting or running by the “external stop” hardwired input.
Power Up Delay Inhibit: min:sec	On power up, the chiller will wait for the Power Up Delay Timer to expire.
Run Inhibit	The chiller is currently being inhibited from starting (and running), but may be allowed to start if the inhibiting or diagnostic condition is cleared. Further information is provided by the sub-mode:
No Circuits Available	The entire chiller is stopped by circuit diagnostics or lockouts that may automatically clear.
Ice Building Is Complete	The chiller is inhibited from running as the Ice Building process has been normally terminated on the evaporator entering temperature. The chiller will not start unless the ice building command (hardwired input or Building Automation System command) is removed or cycled.
Ice to Normal Transition Inhibit	The chiller is inhibited from running for a brief period of time if it is commanded from active ice building mode into normal cooling mode via the ice building hardwired input or Tracer. This allows time for the external system load to “switchover” from an ice bank to the chilled water loop, and provides for a controlled pull down of the loop’s warmer temperature. This mode is not seen if the ice making is automatically terminated on return brine temperature per the mode below.
Start Inhibited by BAS	The chiller is stopped by Tracer® or other Building Automation System (BAS).
Starting is Inhibited by External Source	The chiller is inhibited from starting or running by the “external stop” hardwired input.
Diagnostic Shutdown – Auto Reset	The entire chiller is stopped by a diagnostic that may automatically clear.
Starting is Inhibited by Low Ambient Temperature	The chiller is inhibited based on the outdoor air temperature.
Power Up Delay Inhibit: min:sec	On power up, the chiller will wait for the Power Up Delay Timer to expire.
Chilled Water Control	Chiller is running to provide a chilled water temperature per the active chilled water setpoint (may be as arbitrated from various sources). (For cooling only units, this mode may be suppressed.)
Auto	The chiller is not currently running but can be expected to start at any moment given that the proper conditions and interlocks are satisfied. Further information is provided by the sub-mode:
Waiting For Evaporator Water Flow	The chiller will wait up to 20 minutes in this mode for evaporator water flow to be established per the flow switch hardwired input.
Waiting for A Need to Cool	The chiller will wait indefinitely in this mode, for an evaporator leaving water temperature higher than the Chilled Water Setpoint plus some control dead-band.
Chilled Water Control	Chiller is running to provide a chilled water temperature per the active chilled water setpoint (may be as arbitrated from various sources). (For cooling only units, this mode may be suppressed.)
Waiting to Start	The chiller is not currently running and there is a call for cooling but lead circuit start is delayed by certain interlocks or proofs.
	No chiller sub-modes.
Running	The chiller, circuit, and compressor are currently running. Further information is provided by the sub-mode:
Chilled Water Control	Chiller is running to provide a chilled water temperature per the active chilled water setpoint (may be as arbitrated from various sources). (For cooling only units, this mode may be suppressed.)
Maximum Capacity	The chiller is operating at its maximum capacity.
Capacity Control Softloading	The control is limiting the chiller loading due to capacity based softloading settings.
Demand Limit Softloading	The chiller is running, and loading of individual compressors may be limited by a gradual filter of the chiller’s softloading demand limit setpoint. The starting demand limit and the settling time of this filter is user adjustable as part of the demand limit softload feature. The mode will be displayed as long as the Demand Limit Softloading is ramping or “settling”.
Free Cooling	The chiller is running and Free Cooling is active and delivering cooling capacity without compressor operation. If Free Cooling cannot satisfy the cooling load, mechanical cooling can be sequenced on to satisfy the remaining load.
Free Cooling Bypass Valve Preposition	The Free Cooling bypass valve is prepositioning (i.e. after a power cycle) to its prestart minimum position.
Free Cooling Prestart	This mode is annunciated during the time between the Free Cooling demand going active and when the Free Cooling valve begins to modulate for Free Cooling control.
Running – Limited	At least one circuit on the chiller is currently running, but the operation of any of the circuits on the chiller is being actively limited by a chiller level limit. Other sub modes that apply to the Chiller Running top level modes may also be displayed here. Refer to the list of circuit limit modes for circuit limits that will cause display of this Chiller Level Running Limit mode.

Controls

Table 32. Operating modes – chiller (continued)

Chiller Modes	Description
Demand Limit	The chiller is running and the compressor capacity is unloaded or restricted to load slowly or not at all to keep the chiller from exceeding the demand limit set by the customer.
Demand Limit Softloading	The chiller is running, and loading of individual compressors may be limited by a gradual filter of the chiller's softloading demand limit setpoint. The starting demand limit and the settling time of this filter is user adjustable as part of the demand limit softload feature. The mode will be displayed as long as the Demand Limit Softloading is ramping or "settling".
Shutting Down	The chiller is still running but shutdown is imminent. The chiller is going through a compressor run-unload or extended operational pumpdown of the lag circuit/compressor (or all circuits simultaneously).
Evaporator Water Pump Off Delay min: sec	The evaporator water pump is continuing to run past the shutdown of the compressors, executing the pump off delay timer.
Local Stop, Maximum Capacity	Chiller is in the process of being stopped by TD7 Stop button command
Misc	These sub-modes may be displayed in most of the top level circuit modes.
Manual Evaporator Pump Override	The evaporator water pump relay is on due to a manual command.
Diagnostic Evaporator Water Pump Override	The evaporator water pump relay is on due to a diagnostic.
Manual Compressor Control Signal	Chiller capacity control is being controlled by Operator Display or Service Tool.
Noise Reduction Request	The Noise Reduction Request feature has been activated. If the unit is running, fans will be running at lower speed.
Chilled Water Control	These modes are mutually exclusive and they indicate that the chiller is controlling to the active chilled water setpoint, or the active ice termination setpoint respectively. Chiller is running to provide a chilled water temperature per the active chilled water setpoint (may be as arbitrated from various sources). (For cooling only units, this mode may be suppressed.)
Ice Building	
Evaporator Water Pump X Locked Out	Evaporator Water Pump X has been locked out by manual override from TD7 or TU.
Waiting for BAS Communications	The chiller has not detected communication with the BAS. This mode is only supported by LonTalk systems. Depending on configurations and Setpoint source setting, lack of communication may cause the chiller to shut down and or become inhibited from starting, but if so, the "Starting is Inhibited by BAS" mode will also occur.
Manual Free Cooling Pump Override	Free Cooling pump is being controlled by the Operator Display or Service Tool.

Table 33. Operating modes – circuit

Circuit Level Modes	Description
Stopped	The circuit is not running, and cannot run without intervention.
Front Panel Circuit Lockout	The circuit is manually locked out by the circuit lockout setting – the nonvolatile lockout setting is accessible through either the Operator Display or Service Tool.
External Circuit Lockout	The respective circuit is locked out by the external circuit lockout binary input.
No Compressors Available	The circuit cannot run because necessary compressors are being prevented from running.
Diagnostic Shutdown - Manual Reset	The chiller has been shut down on a latching diagnostic that requires manual intervention to reset.
Run Inhibit	The given circuit is currently being inhibited from starting (and running), but may be allowed to start if the inhibiting or diagnostic condition is cleared.
Diagnostic Shutdown - Auto Reset	The circuit has been shutdown on a diagnostic that may clear automatically.
No Compressors Available	The circuit cannot run because necessary compressors are being prevented from running.
Auto	The circuit is not currently running but can be expected to start at any moment given that the proper conditions are satisfied.
Calibrating EXV	This submode is displayed when the EXV is performing a calibration. A calibration is only performed when the chiller is not running and never more frequently than once every 24 hours.
Waiting to Start	The chiller is going through the necessary steps to allow the lead circuit to start.
Start Inhibited Waiting For Oil	The compressor (and thus its circuit) will wait up to 2 minutes in this mode for oil level to appear in the oil tank.
Waiting For EXV Preposition	The circuit will wait for the time it takes the EXV to get to its commanded pre-position prior to starting the compressor. This is typically a relatively short delay and no countdown timer is necessary (less than 15 seconds)
Evaporator Isolation Valve Opening	The evaporator isolation valve, if installed, is going through the opening process to allow the circuit to start. This submode can occur with other top level modes, but this is the most common scenario.
Running	A compressor on the given circuit is currently running.
Part-Load Efficiency Optimization	The circuit has part-load efficiency optimization that is active. Condenser fan speed will be decreased while evaporator capacity is held constant to improve unit EER.
Evaporator Isolation Valve Opening	The evaporator isolation valve, if installed, is going through the opening process to allow the circuit to start. This submode can occur with other top level modes, but this is the most common scenario.
Free Cooling Bypass Valve Preposition	The Free Cooling bypass valve is repositioning (i.e. after a power cycle) to its prestart minimum position.
Free Cooling Prestart	This mode is annunciated during the time between the Free Cooling demand going active and when the Free Cooling valve begins to modulate for Free Cooling control.
Running – Limit	The circuit, and compressor are currently running, but the operation of the chiller/compressor is being actively limited by the controls. Further information is provided by the sub-mode.* See the section below regarding criteria for annunciation of limit modes
Condenser Pressure Limit	The circuit is experiencing condenser pressures at or near the condenser limit setting. Compressors on the circuit will be unloaded to prevent exceeding the limits.*
Evaporator Temperature Limit	The circuit is experiencing saturated evaporator temperatures at or near the Low Refrigerant Temperature Cutout setting. Compressors on the circuit will be unloaded to prevent tripping.*
EXV Capacity Limit	The EXV is near or beyond 95% wide open, and the capacity of the circuit (compressor speed) is being held or reduced in order to prevent loss of oil return or insufficient drive cooling.
Establishing Minimum Capacity – Low Differential Pressure	For circuits with manifolded compressors only, the compressor(s) are being loaded to meet requested capacity. See Low Compressor Differential Pressure Limit spec. Note: This mode can be displayed at a Compressor level as well.
Shutting Down	The circuit is preparing to de-energize the compressor.
Operational Pumpdown	The circuit is in the process shutting down by performing an operational pumpdown just prior to stopping the last running compressor. The EXV is commanded closed. Pumpdown will terminate when both the liquid level and the evap pressure are low (below specific criteria) or after a specific time has expired.
Evaporator Isolation Valve Closing	The evaporator isolation valve, if installed, is going through the closing process to avoid charge migration and freeze risks. This submode can occur with other top level modes, but this is the most common scenario.
Misc.	These sub modes may be displayed in most of the top level circuit modes.
EXV Pressure Equalization	The circuit is performing an EXV Equalization process. This can occur either during the circuit off mode, or as part of the circuit startup sequence.
Diagnostic Shutdown - Manual Reset	The circuit has been shut down on a latching diagnostic that requires manual intervention to reset.



Controls

Table 34. Operating modes – compressor

Compressor Level Modes	Description
Stopped	The compressor is not running, and cannot run without intervention.
Diagnostic Shutdown - Manual Reset	The compressor has been shut down on a latching diagnostic that requires manual intervention to reset.
Front Panel Compressor Lockout	Compressor is manually locked out by the compressor lockout setting – the nonvolatile lockout setting is accessible through either the Operator Display or Service Tool.
Low Oil Flow Cool Down Time min:sec	See oil flow protection spec.
Run Inhibit	The given compressor is currently being inhibited from starting (and running), but may be allowed to start if the inhibiting or diagnostic condition is cleared.
Diagnostic Shutdown - Auto Reset	The compressor has been shut down on a diagnostic that may clear automatically.
Auto	The circuit is not currently running but can be expected to start at any moment given that the proper conditions are satisfied.
Running	A compressor on the given circuit is currently running.
Minimum Capacity – High Discharge Temperature	The compressor is running with high discharge temperatures and is being forced loaded to its step load point, without regard to the leaving water temperature control, to prevent tripping on high compressor discharge temperature.
Establishing Minimum Capacity – High Oil Temperature	The compressor is running with high oil temperatures and is being force loaded to its step load point, without regard to the leaving water temperature control, to prevent tripping on high compressor oil temperature.
Running - Limit	The compressor is currently running, but the operation of the chiller/compressor is being actively limited by the controls. Further information is provided by the sub-mode.* See the section below regarding criteria for annunciation of limit modes
High Motor Temp Limit	Current operating conditions are generating a risk of a high motor temperature that may result in overheating of the rotor or stator.
Current Limit	The compressor is running and its capacity is being limited by high currents. The current limit setting is 120% RLA (to avoid overcurrent trips) or lower as set by the compressor's "share" of the active current limit (demand limit) setting for the entire chiller.*
Hot Start Limit	This mode will occur if the compressor's suction saturated temperature exceeds the Hot Start Threshold Temperature at the point at which the step load for the respective circuit would be desired. This is often the case in a high water temperature pulldown. While in this mode, the compressor will not be allowed to load past its minimum load capacity step, but it will not inhibit other compressors from staging on. This mode is necessary to prevent nuisance trips due to compressor overcurrent or high pressure cutout. Reasonable pulldown rates can still be expected despite this limit, since the compressor's capacity even at partial load is much greater at high suction saturated temperatures.
Compressor Differential Pressure Limit	The compressor is running and is inhibited to load or unload in order to prevent conditions that would exceed safety trip points. See High Compressor Differential Pressure Limitation spec.
Compressor Pressure Ratio Limit	The compressor is running and is inhibited to load or unload in order to prevent conditions that would exceed safety trip points. See High Compressor Differential Pressure Limitation spec.
Establishing Minimum Capacity – Low Differential Pressure	For manifolded compressors only, the Compressor's Low Differential Pressure Protection Integral has risen to 30% of its trip value. This will force load the female load step on that circuit's compressor. Note: This mode can be displayed at a Circuit level as well.
Oil Return Limit	A compressor is in this limit due to low discharge superheat. The oil return solenoid valve will be cycled closed/open which allows the discharge gas temperature and the corresponding discharge superheat to increase, improving oil quality to the compressor.
Shutting Down	The circuit is preparing to de-energize the compressor.
Compressor Unloading	The compressor is in its run unload time. The run unload time must expire before the compressor will shut down. (The unload time is typically about 5 seconds.)
Misc.	The circuit is preparing to de-energize the compressor.
Service Pumpdown	The compressor is currently performing a service pumpdown.
Restart Inhibit min:sec	If there is accumulated Restart Inhibit Time, it must expire before a compressor is allowed to start.

Alarms

You can use the display to view alarms and to reset them. Alarms are communicated to the display immediately upon detection.

Viewing the Alarms Screen

Touch the Alarms button in the home screen menu (Figure 41, p. 60) to view the Alarms screen. A table of active alarms appears that is organized chronologically with the most recent at the top of the list, as shown below. This example shows the default view, which appears each time you return to the screen. List can be sorted by any of the other columns if desired.

Note: A page number appears in the lower right corner of the screen. If a screen contains more than one page, up/down arrows also appear for viewing the other pages.

Figure 44. Alarm screen

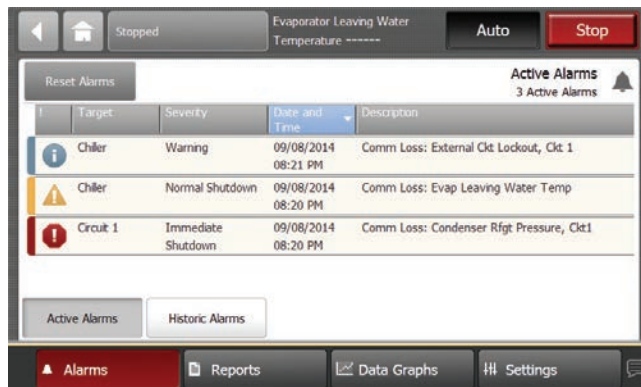

The Alarms screen is accessible by depressing the Alarms enunciator. A verbal description will be provided.

A scrollable list of the last active Alarms is presented. Performing a “Reset Alarms” will reset all active Alarms regardless of type, machine or circuit. The scrollable list will be sorted by time of occurrence.

“Alarms” Key Behavior:

- Alarm Shutdown (immediate) has occurred: Flash red
- Alarm Shutdown (normal) has occurred: Flash yellow
- Informational warning is present: Flash blue
- No alarms present: Default button color, not flashing

Reports

You can use the Tracer display to view a variety of reports and to create and edit a custom report. All reports contain live data that refreshes every 2–5 seconds.

Viewing the Reports Screen

Touch the Reports button in the main menu area (Figure 4) to view the Reports screen. The Reports screen contains the following buttons:

- Custom Report1

- Custom Report2
- Custom Report3
- Evaporator
- Condenser
- Compressor
- Motor
- About
- Operating Modes
- Log Sheet
- ASHRAE Chiller Log

Each button links to the report named on the button.

Figure 45. Report screen

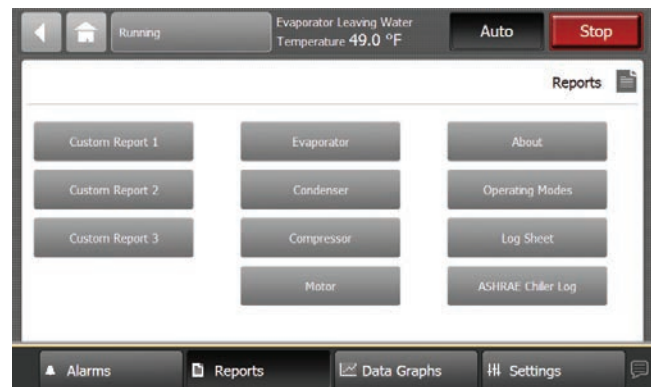

The Reports tab allows a user to select from a list of reports headings. Each report will generate a list of status items as defined in the tables that follow.

Editing a Custom Report

You can edit the custom report by adding, removing, or re-order data as follows:

1. On the Custom Report screen, touch Edit. The Edit Custom Report screen appears.
2. Add, remove, or re-order as follows:
 - a. To add an item to the custom report, touch it. It responds by changing to blue. You can use the arrows to scroll through the rest of the items that can be added to the custom report. Then touch Add to move the selected item to the box on the right side of the screen.
 - b. To remove an item from the custom report, touch it. It responds by changing to blue. You can use the arrows to scroll through the rest of the items that can be removed from the custom report. Then touch Remove to move the selected item to the box on the left side of the screen.
 - c. To re-order items in the custom report, touch it. It responds by changing to blue. Use the arrows to change the order of a highlighted item.

- To save and view your edited custom report, touch Save.

Figure 46. Edit custom report screen

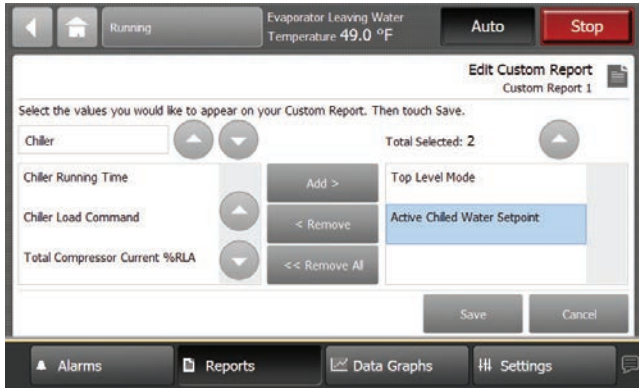

Figure 47. Report evaporator screen

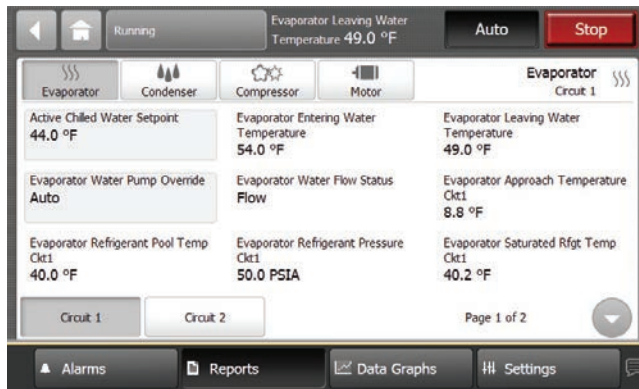

Table 35. Report evaporator screen items

Description	Resolution	Units
Active Chilled Water Setpoint	XXX.X	°F/°C
Evaporator Entering Water Temperature	XXX.X	°F/°C
Evaporator Leaving Water Temperature	XXX.X	°F/°C
Evaporator Water Pump Override	Auto/On	
Evaporator Water Flow Status	Flow/No Flow	
Evaporator Approach Temperature CktX	XXX.X	°F/°C
Evaporator Refrigerant Pool Temp CktX	XXX.X	°F/°C
Evaporator Refrigerant Pressure CktX	XXX.X	PSI/kPa
Evaporator Saturated Rfgt Temp CktX	XXX.X	°F/°C
Evap Isolation Valve Status CktX	Closed/Open/ Closing/ Opening/ Unknown	
Evaporator Shell Rfgt Pressure CktX	XXX.X	PSI/kPa
Evaporator Shell Sat Rfgt Temp CktX	XXX.X	°F/°C
Oil return Solenoid Valve CprsrXA	Open/Closed	
Oil return Solenoid Valve CprsrXB	Open/Closed	
EXV Percent Open CktX	XXX.X	%
Evaporator Differential Water Pressure	XXX.X	PSID/kPad

Table 35. Report evaporator screen items (continued)

Description	Resolution	Units
Water System Differential Water Pressure	XXX.X	PSID/kPad
Evaporator Water Bypass Valve Position	XXX.X	%
Evaporator Water Pump Speed Command	XXX.X	%
Evaporator Water Pump Running Time Pump 1	XXXX:XX	Hr: Min
Evaporator Water Pump Running Time Pump 2	XXXX:XX	Hr: Min
Free Cooling Capacity	XXX.X	%
Free Cooling Valve Percent Open	XXX.X	%
Free Cooling Bypass Valve Percent Open	XXX.X	%
Free Cooling Entering Water Temperature	XXX.X	°F/°C

Figure 48. Report condenser screen

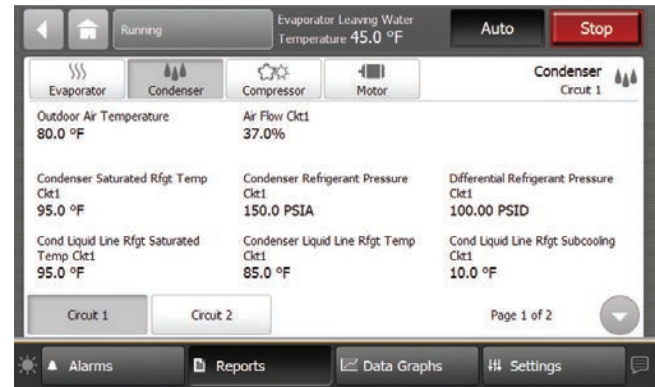

Table 36. Report condenser screen items

Description	Resolution	Units
Outdoor Air Temperature	XXX.X	°F/°C
Air Flow CktX	XXX.X	%
Condenser Saturated Rfgt Temp CktX	XXX.X	°F/°C
Condenser Refrigerant Pressure CktX	XXX.X	PSI/kPa
Differential Refrigerant Pressure CktX	XXX.X	PSID/kPad
Cond Liquid Line Rfgt Saturated Temp CktX	XXX.X	°F/°C
Condenser Liquid Line Rfgt Temp CktX	XXX.X	°F/°C
Condenser Liquid Line Rfgt Subcooling CktX	XXX.X	°F/°C
EXV Percent Open CktX	XXX.X	%
Condenser Liquid Line Rfgt Pressure CktX	XXX.X	PSI/kPa
Condenser Refrigerant Tank Valve CktX	Open/Closed	

Figure 49. Report compressor screen

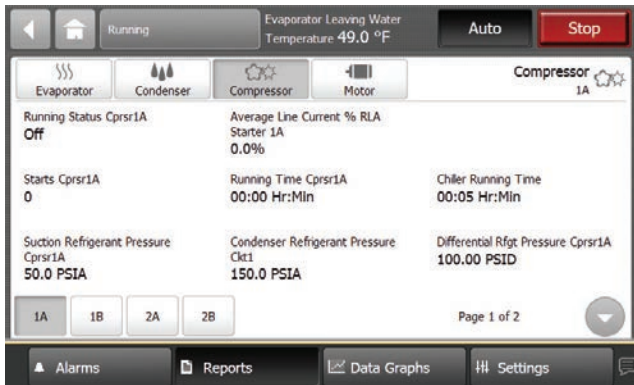
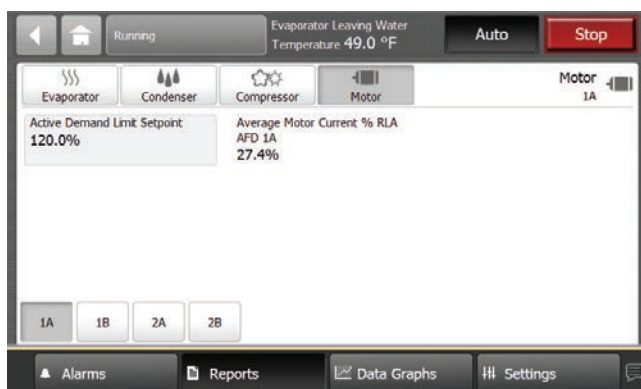

Table 37. Report compressor screen items

Description	Resolution	Units
Running Status	On/Off	
Average Motor Current % RLA AFD XX or Average Line Current % RLA Starter XX	XXX.X	%
Speed Command CprsrXX	XXXX.X	rpm
Starts CprsrXX	XXXX	
Running Time CprsrXX	XXXX.XX	Hr: Min
Chiller Running Time	XXXX.XX	Hr: Min
Suction Refrigerant Pressure CprsrXX	XXX.X	PSI/kPa
Condenser Refrigerant Pressure CktX	XXX.X	PSI/kPa
Differential Rfght Pressure CprsrXX	XXX.XX	PSID/kPaD
Oil Loss Level Sensor CktX	Wet/Dry	
Discharge Temperature CprsrXX	XXX.X	°F/°C
Discharge Superheat CprsrXX	XXX.X	°F/°C
Oil Pressure CprsrXX	XXX.X	PSI/kPa
Oil Temperature CprsrXX	XXX.X	°F/°C

**Figure 50. Report motor screen—
compressors 1A and 2A**



**Table 38. Report motor screen items —
compressors 1A and 2A**

Description	Resolution	Units
Active Demand Limit Setpoint	XXX.X	%
Average Motor Current % RLA AFD XX	XXX.X	%

**Figure 51. Report motor screen—
compressors 1B and 2B (if present)**

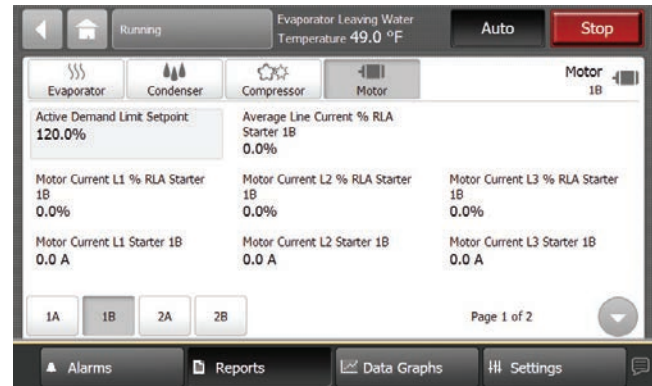

**Table 39. Report motor screen items —
compressors 1B and 2B (if present)**

Description	Resolution	Units
Active Demand Limit Setpoint	XXX.X	%
Average Line Current %RLA AFD XX	XXX.X	%
Motor Voltage AB Starter XX	XXXX.X	Volts
Motor Current L1 % RLA Starter XX	XXX.X	%
Motor Current L2 % RLA Starter XX	XXX.X	%
Motor Current L3 % RLA Starter XX	XXX.X	%
Motor Current L1 Starter XX	XXX.X	Amps
Motor Current L2 Starter XX	XXX.X	Amps
Motor Current L3 Starter XX	XXX.X	Amps
Energy Consumption Last Reset		MM/DD/YYYY HH:MM AM/PM
Energy Consumption Resettable	XXXX	kWh
Energy Consumption NonReset	XXXX	kWh
Unit Power Consumption	XXXX	kW
Chiller Power Demand	XXXX	kW

Equipment Settings

You can use the TD7 display to monitor and change a variety of equipment settings.

Viewing the Settings Screen

Touch the Settings button in the main menu area (see [Figure 41, p. 60](#)) to view the Settings screen. Equipment Settings identifies a column of buttons located on the screen (see the outlined column in [Figure 52](#)). The buttons are:

- Chiller Settings
- Feature Settings
- Chilled Water Reset
- Manual Control Settings
- Service Settings

Each of these buttons provide access to a screen that contains additional buttons related to each topic. This section provides detailed information about these screens.

Figure 52. Setting screen

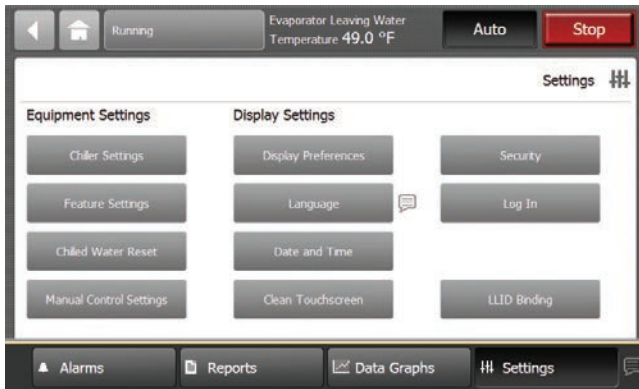

Viewing and Changing Equipment Settings

Each button in the Equipment Settings column on the Settings screen takes you to a menu screen that contains a group of buttons. Each button displays the name of a setting and its current value (see figure below). Touch any button to view a screen where you can change the setting for the feature shown on the button.

Note: A page number appears in the lower right corner of the screen. If a screen contains more than one page, up/down arrows also appear for viewing the other pages, as in figure below.

Figure 53. Equipment setting screen (Chiller setting shown)

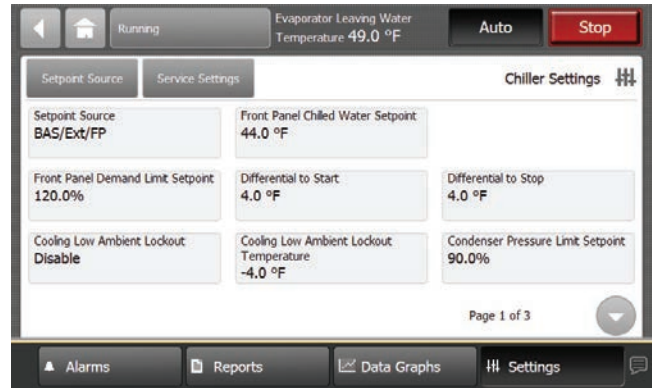

To change an equipment setting, follow this procedure:

1. Touch one of the button in the Equipment Settings column on the Settings screen, such as Chiller Settings. The corresponding screen appears (in this case, the Chiller Settings screen).
2. Touch the button that shows the equipment setting you want to change. A screen that allows you to change the equipment setting appears. There are two types of these screens:
 - a. For screens with button selections ([Figure 54](#)), touch the button that represents the setting you want. The button becomes shaded, and a Save button appears at the bottom of the screen.
 - b. For screens with numerical keypads ([Figure 55](#)), touch the appropriate numbers to change the current value. The new value appears above the keypad.
3. Touch Save to complete the change. The current value is updated in the upper left side of the screen, demonstrating that the change has been communicated to the Tracer UC800 controller. The screen you were previously viewing appears.

Figure 54. Chilled water reset type screen

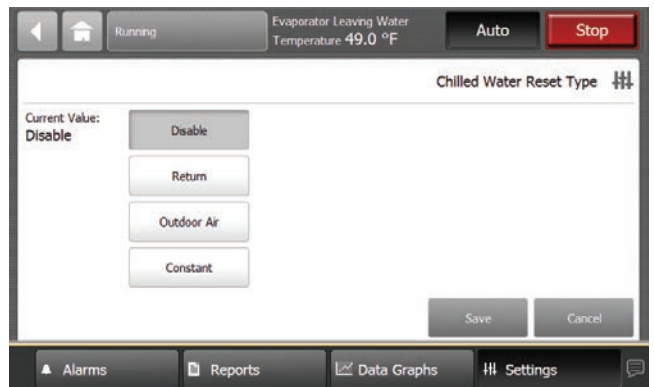
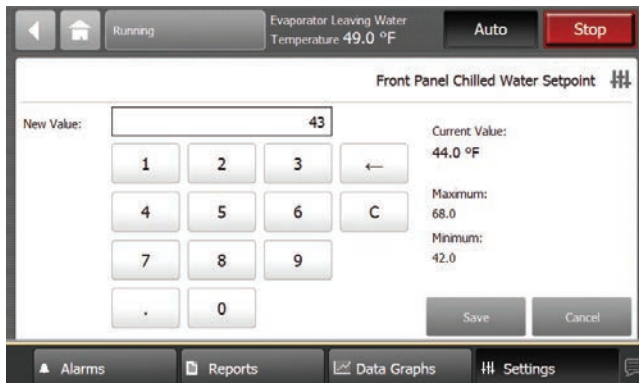

Figure 55. Changed chilled water setpoint screen



Keypad features:

- When you enter a new number, the value in the New value field is deleted and replaced with the new entry.
- The backspace (arrow) key deletes the characters you previously entered.
- If the keypad is used to enter a setpoint that is out of range, an error dialog will appear when you touch the Save button.
- Keypads that allow negative numbers have positive and negative number (+/-) keys.

Table 40. Settings screen items

Description	
Chiller Settings	
Setpoint Source	
Front Panel Chilled Water Setpoint	
Auxiliary Chilled Water Setpoint	
Front Panel Demand Limit Setpoint	
Differential to Start	
Differential to Stop	
Evaporator Water Pump Off Delay	
Evaporeator Diff Water Pressure Setpoint	
Water System Diff Water Pressure Setpoint	
Front Panel Ice Building Command	
Front Panel Ice Termination Setpoint	
Front Panel Noise Reduction Request	
Noise Reduction Cond Fan Speed Clamp	
Power-Up Start Delay	
Chiller Power Demand Time Period	
Front Panel Free Cooling Command	
Free Cooling Target Offset	
Feature Settings	
External Chiller Water Setpoint Enable	
External Demand Limit Setpoint Enable	
Staging Sequence	
LCI-C Diagnostic Encoding	
Ice Building Feature Enable	

Table 40. Settings screen items (continued)

Description	
Manual Control Settings - Chiller	
Manual Capacity Control	Auto/Manual
Evaporator Water Pump Override	Auto/On
Clear Energy Consumption	XXX kWh
Evaporator Water Pump Lockout Pump 1	Not Locked Out/ Locked Out
Evaporator Water Pump Lockout Pump 2	Not Locked Out/ Locked Out
Free Cooling Valve Override	Auto/Manual
Free Cooling Bypass Valve Override	Auto/Manual
Manual Control Settings - Circuit 1	
Front Panel Circuit Lockout Ckt1	Not Locked Out/ Locked Out
EXV Manual Control Override Ckt1	Auto/Manual
Evap Isolation Valve Override Ckt1	Auto/Close/Open
Front Panel Compressor Lockout Cprsr 1A	Not Locked Out/ Locked Out
Service Pumpdown Command Cprsr1A	Abort/Start
Front Panel Compressor Lockout Cprsr 1B	Not Locked Out/ Locked Out
Service Pumpdown Command Cprsr1B	Abort/Start
Manual Control Settings - Circuit 2	
Front Panel Circuit Lockout Ckt2	Not Locked Out/ Locked Out
EXV Manual Control Override Ckt2	Auto/Manual
Evap Isolation Valve Override Ckt2	Auto/Close/Open
Front Panel Compressor Lockout Cprsr 2A	Not Locked Out/ Locked Out
Front Panel Compressor Lockout Cprsr 2B	Not Locked Out/ Locked Out
Service Pumpdown Command Cprsr2A	Abort/Start
Service Pumpdown Command Cprsr2B	Abort/Start

Service Settings

Setpoints on the Service Settings screen are only intended for use by experienced service personnel. Setpoints include security, if enabled.

The Service Settings screen is found through Chiller Settings, and includes a warning message for the user.

Figure 56. Warning message

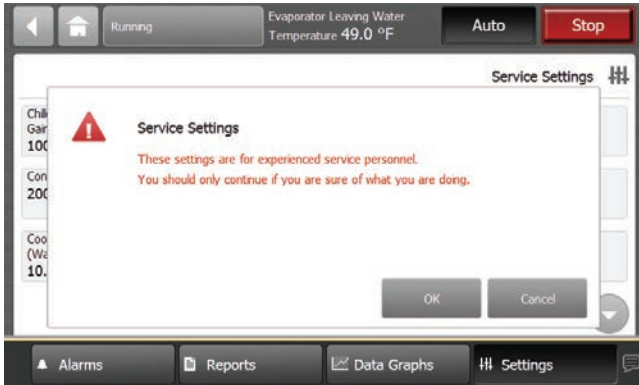
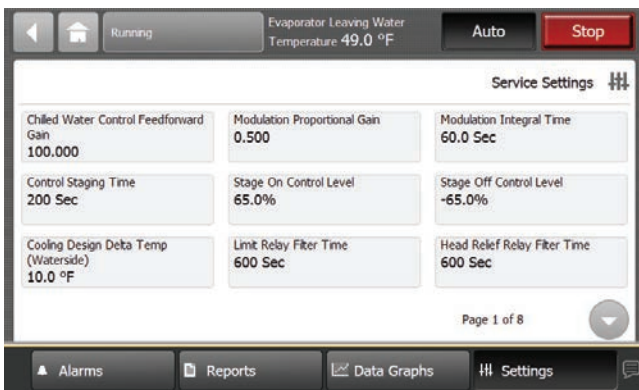

Figure 57. Service settings screen



Display Settings

You can use the Tracer AdaptiView display to change the format of the information that appears on the display, and to clean the touch screen.

Touch the Settings button in the main menu area (Figure 52, p. 68) to view the Settings screen. Display Settings identifies a column of buttons located on the screen (see figure below). The buttons are:

- Display Preferences
- Language
- Date and Time
- Clean Display

Each button provide access to a screen that is related to the button name.

Viewing and Changing Display Preferences

On the Settings screen, touch Display Preferences to view a screen containing these buttons (see figure below):

- Date Format
- Date Separator
- Time Format
- Unit System

- Pressure Units
- Number Format

Figure 58. Display preference screen

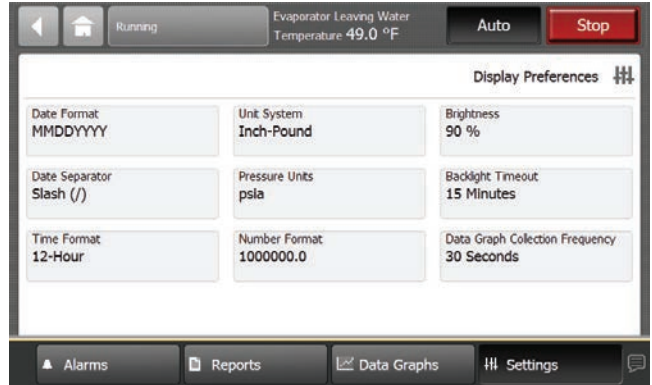

Each of the buttons shows the name of a display preference and its format (current value). Touch any of these buttons to view a screen where you can change the format. The button representing the format currently used is shaded (see the “MMDDYYYY” button).

Figure 59. Date format page

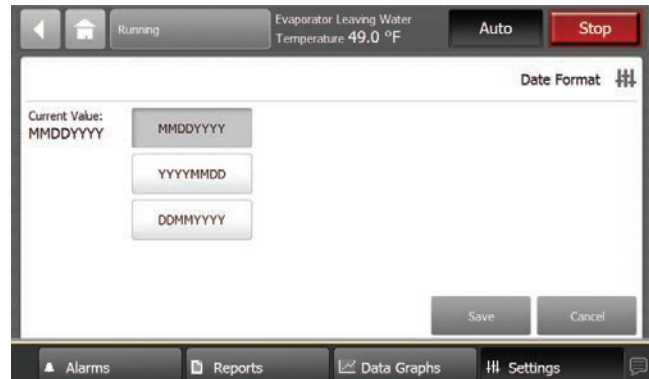

To change the format:

1. Touch the button that shows that format you prefer.
2. Touch Save to confirm your selection and to return to the Display Preferences screen.

Date Format

Use the Date Format screen to choose from the following date formats:

- MMDDYYYY (default)
- YYYYMMDD
- DDMMYYYY

Date Separator

Use the Date Separator screen to choose from the following date formats:

- None
- Slash (default)
- Hyphen

Time Format

Use the Time Format screen to choose from the following time formats:

- 12 hour (default)
- 24 hour

Units System

Use the Display Units screen to choose from the following display units:

- SI
- Inch-Pounds (default)

Pressure Units

Use the Pressure Units screen to choose from the following pressure units:

- kPaA (default if “SI” is chosen for display units)
- kPaG
- PSIA (default if “Inch-Pound” is chosen for display units)
- PSIG

Number Format

- 1000000.0
- 1000000,0

Figure 60. Language page



The language that is currently in use on the display is expressed as the current value on the Language screen. The button that displays the current value is shaded (see the “English” button in Figure 19 as an example).

To change the language:

1. Touch the button that identifies the language you prefer.

2. Touch Save to confirm your selection and to return to the Settings screen.

Figure 61. Date and time screen

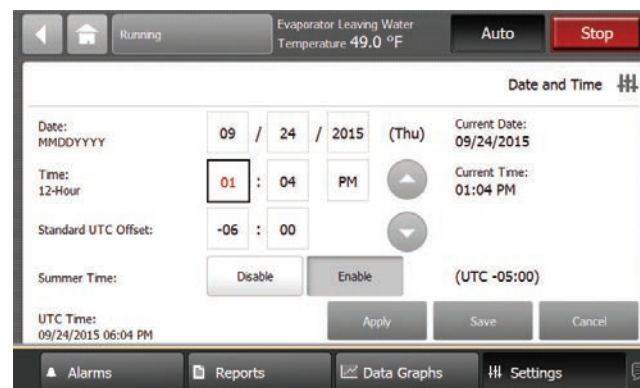

The current date and time for the display is expressed as the current value. The current value appears below the center line on the screen.

Above the center line, the following date and time attributes appear:

- Month
- Day
- Year
- Hour
- Minute
- AM/PM

To change the date or time:

1. Touch the square presenting the attribute you want to change. The square becomes highlighted.
2. Touch the up or down arrow key on the screen until the your desired selection appears. Repeat the process for any other attributes you want to change.
3. Touch Save to confirm your selection and return to the Settings screen.

Note: Alternately, fields can be edited by touching the highlighted square a second time to access a keypad.

Cleaning the Display

On the Settings screen, touch Clean Display to disable the Tracer AdaptiView display screen for 5 seconds after finger is removed. This process allows screen cleaning without it responding to touch. During this time, the screen is black with a number in the center that counts down the seconds. After 5 seconds, the Settings screen reappears.

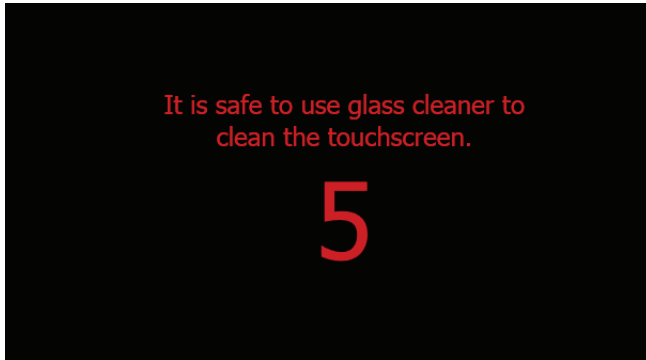
Figure 62. Countdown screen

Security Settings

If security is enabled, the Tracer AdaptiView display requires that you log in with a four-digit security PIN to make setting changes that are protected by security. This feature prevents unauthorized personnel from doing so. There are two levels of security, each allowing specific changes to be made.

You can view all data without logging in. The log-in screen appears only when you try to change a setting that is protected by security, or when you touch the Log in button from the Settings screen.

Disabling/Enabling Security

The Tracer AdaptiView display gives you the ability to disable or enable the security feature that allows a user to log in and log out.

To disable security, you must be logged in:

1. From the Settings screen, touch the Security button. The Security screen appears (see figure below).

Note: If you are logged out, the Log in screen appears.

2. Touch the Disable button. The button becomes shaded.
3. Touch Save. The Settings screen appears with only the Security button visible. The Log in/Logout button is gone.

To enable security:

1. From the Settings screen, touch the Security button. The Security screen appears.
2. Touch the Enable button. The button becomes shaded.
3. Touch Save. The Settings screen appears with a Log out button, in addition to the Security button.

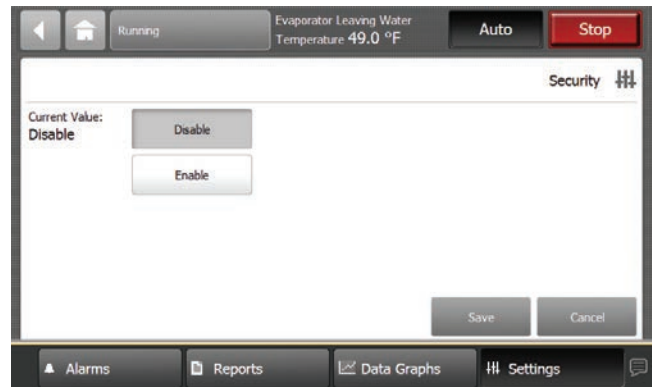
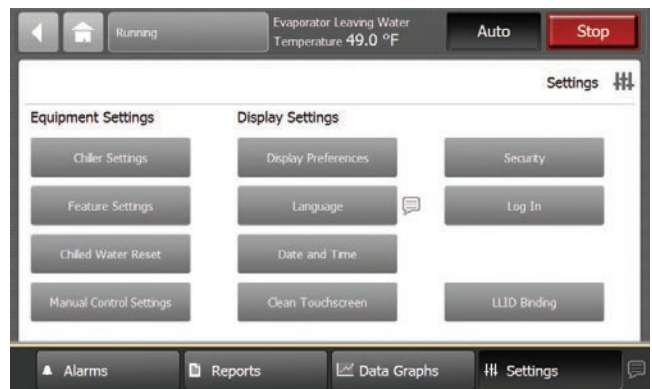
Figure 63. Security screen - disable

Figure 64. Security settings screen

Logging In

There are two levels of security:

- Security Level 1 allows users to change a limited group of secure settings. The default security PIN is 1111.
- Security Level 2 allows users to change all secure settings. The default security PIN is 7123.

A technician must use the Tracer TU service tool to define a different PIN, or to recall a PIN that has been forgotten. When defining a PIN in Tracer TU, the technician enters a 4-digit PIN that corresponds with the desired level of security.

To log in:

1. Touch the Log in button. The Log in screen appears.
2. Use the keypad to enter your PIN.
 - a. The PIN is a four-digit number, which was configured for your system with the Tracer TU service tool.
 - b. As you enter the number, the PIN remains hidden by asterisks.

Note: If you enter an invalid PIN, an error message appears on the Log in screen.

3. Touch Save.

- a. If you viewed the Log in screen from touching Log in on the Settings screen, the Settings screen appears with a Log out button on it.
- b. If the Log in screen appeared when you tried to change a setting, you return to that setting screen.

Note: The PIN is valid until 30 minutes of inactivity passes, or until you log out.

Figure 65. Log in screen

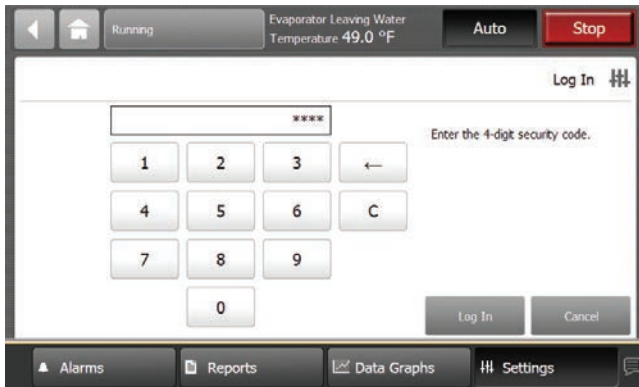

Logging Out

To log out:

1. Touch the Log out button. A confirmation screen appears as shown below.
2. Touch Yes to confirm that you want to log out. The Settings screen appears with a Log in button on it.

Figure 66. Log out confirmation screen

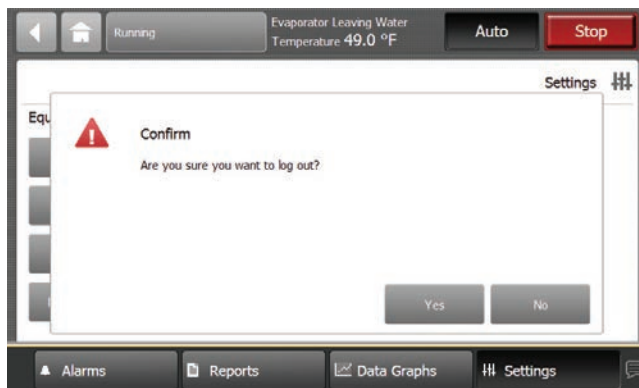

Tracer TU

The AdaptiView™ TD7 operator interface allows for daily operational tasks and setpoint changes. However, to adequately service Sintesis chillers, Tracer® TU service tool is required. (Non-Trane personnel, contact your local Trane office for software purchase information.) Tracer TU adds a level of sophistication that improves service technician effectiveness and minimizes chiller downtime. This portable PC-based service-tool software supports service and maintenance tasks, and is required for software upgrades, configuration changes and major service tasks.

Tracer® TU serves as a common interface to all Trane® chillers, and will customize itself based on the properties of the chiller with which it is communicating. Thus, the service technician learns only one service interface.

The panel bus is easy to troubleshoot using LED sensor verification. Only the defective device is replaced. Tracer TU can communicate with individual devices or groups of devices.

All chiller status, machine configuration settings, customizable limits, and up to 100 active or historic diagnostics are displayed through the service-tool software interface.

LEDs and their respective Tracer TU indicators visually confirm the availability of each connected sensor, relay, and actuator.

Tracer TU is designed to run on a customer's laptop, connected to the Tracer AdaptiView control panel with a USB cable. Your laptop must meet the following hardware and software requirements:

- 1 GB RAM (minimum)
- 1024 x 768 screen resolution
- Ethernet 10/100 LAN card
- Available USB 2.0 port
- Microsoft® Windows® 7 Enterprise or Professional operating system (32-bit or 64-bit) or Windows 8.1.

Important: TracerTU V8.6 was the final release to support Windows XP. Beginning with Tracer TU V9.0, you will need to migrate to Windows 7 or Windows 8.1 operating system.

Notes:

- Tracer TU is designed and validated for this minimum laptop configuration. Any variation from this configuration may have different results. Therefore, support for Tracer TU is limited to only those laptops with the configuration previously specified.
- For more information, see TTU-SVN01*-EN Tracer TU Getting Started Guide.



Controls

Integrated Rapid Restart

Figure 67. Tracer TU

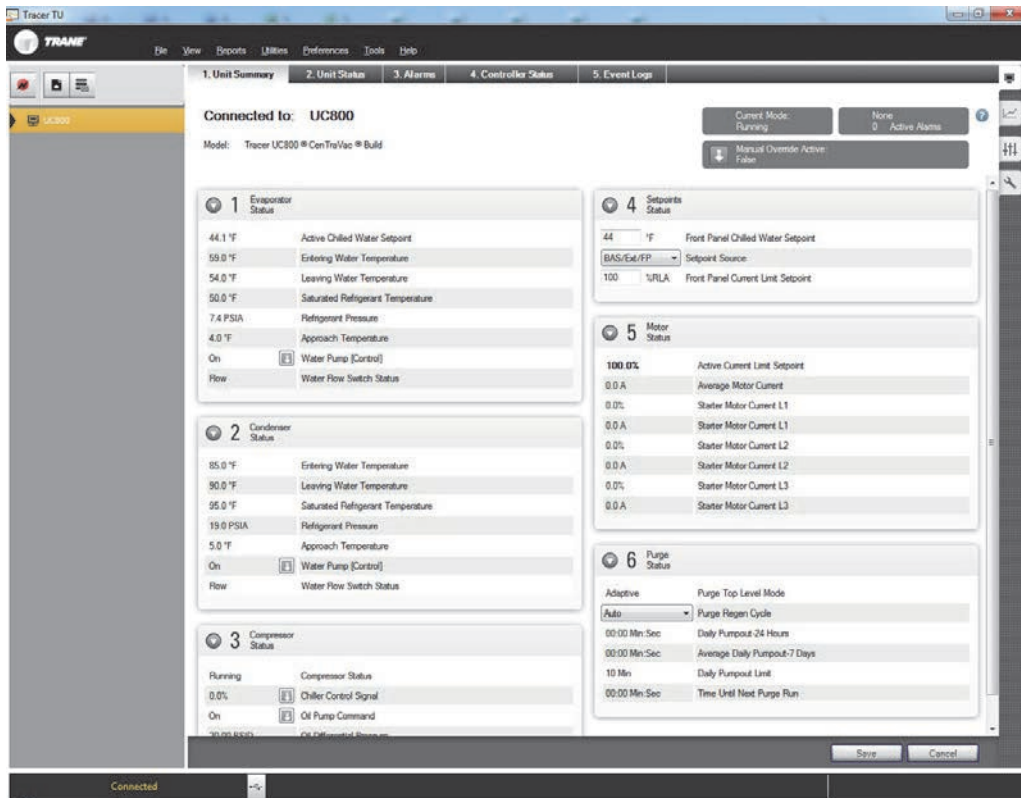

Chiller controls are designed and engineered for Rapid Restart. In the event of a power interruption, the chiller will start a compressor before the front panel display is fully powered up eliminating the need for UPS. Advanced features and functionality are built into the chillers. Bringing a chiller back online rapidly after a loss of power is critical to operations in mission critical environments, which demand the highest levels of reliability.

Under optimal conditions, it can restart in as little as 45 seconds with no need for uninterrupted power supply (UPS). 80 percent cooling load can be achieved in less than 2.5 minutes after power restoration.



Pre-Start

Upon completion of installation, complete the Sintesis™ RTAF Installation Completion Check Sheet and Request for Trane Service checklist in chapter “[Log and Check Sheets](#),” p. 117.

Important: *Start-up must be performed by Trane or an agent of Trane specifically authorized to perform start-up and warranty of Trane products. Contractor shall provide Trane (or an agent of Trane specifically authorized to perform start-up) with notice of the scheduled start-up at least two weeks prior to the scheduled start-up.*



Start-Up and Shutdown

Important: Initial unit commissioning start-up must be performed by Trane or an agent of Trane specifically authorized to perform start-up and warranty of Trane products. Contractor shall provide Trane (or an agent of Trane specifically authorized to perform start-up) with notice of the scheduled start-up at least two weeks prior to the scheduled start-up.

Unit Start-Up

NOTICE:

Equipment Damage!

Ensure that the compressor and oil sump heaters have been operating properly for a minimum of 24 hours before starting. Failure to do so could result in equipment damage.

If required, once the system has been operating for approximately 30 minutes and has become stabilized, complete the remaining start-up procedures, as follows:

1. Check the evaporator refrigerant pressure and the condenser refrigerant pressure under Refrigerant Report on the AdaptiView™ TD7. The pressures are referenced to sea level (14.6960 psia).
2. Check the EXV sight glasses after sufficient time has elapsed to stabilize the chiller. The refrigerant flow past the sight glasses should be clear. Bubbles in the refrigerant indicate either low refrigerant charge or excessive pressure drop in the liquid line or a stuck open expansion valve. A restriction in the line can sometimes be identified by a noticeable temperature differential between the two sides of the restriction. Frost will often form on the line at this point. Proper refrigerant charges are shown in the General Information Section.

Important: A clear sight glass alone does not mean that the system is properly charged. Also check system subcooling, liquid level control and unit operating pressures.

If chiller is limited by any limiting conditions, contact local Trane service organization for more information.

Temporary Shutdown And Restart

To shut the unit down for a short time, use the following procedure:

1. Press the STOP key on the Adaptiview TD7. The compressors will continue to operate and an operational pumpdown cycle will be initiated.
2. UC800 pump control will turn off the pump (after a minimum 1 min. delay) when the STOP key is pressed

and automatically restart the pump when the unit starts normally.

3. The unit will start normally, provided the following conditions exist:
 - a. The UC800 receives a call for cooling and the differential-to-start is above the setpoint.
 - b. All system operating interlocks and safety circuits are satisfied.

Extended Shutdown Procedure

The following procedure is to be followed if the system is to be taken out of service for an extended period of time, e.g. seasonal shutdown:

1. Test the unit for refrigerant leaks and repair as necessary.
2. Open the electrical disconnect for the chilled water pump. Lock the switches in the "OPEN" position.

NOTICE:

Pump Damage!

To prevent pump damage, lock the chilled water pump disconnects open and verify pump is off before draining water.

3. Close all chilled water supply valves. Drain the water from the evaporator.
4. With the water drained from evaporator, disconnect 115 power from evaporator heaters at terminals 1X4-1 and 1X4-2.

NOTICE:

Evaporator Heater Damage!

Applying power to the evaporator heaters when no water is present could result in damage to heaters.

5. Open the main electrical disconnect and lock in the "OPEN" position.

NOTICE:

Equipment Damage!

Lock the disconnect in the "OPEN" position to prevent accidental start-up and damage to the system when it has been shut down for extended periods.

6. At least every three months (quarterly), check the refrigerant pressure in the unit to verify that the refrigerant charge is intact.

Seasonal Unit Start-Up Procedure

1. Close all valves and re-install the drain plugs in the evaporator.
2. Service the auxiliary equipment according to the start-up/maintenance instructions provided by the respective equipment manufacturers.
3. Close the vents in the evaporator chilled water circuits.
4. Open all the valves in the evaporator chilled water circuits.
5. Open all refrigerant valves to verify they are in the open condition.
6. If the evaporator was previously drained, vent and fill the evaporator and chilled water circuit. When all air is removed from the system (including each pass), install the vent plugs in the evaporator water boxes.
7. Check the adjustment and operation of each safety and operating control.
8. Refer to the sequence for daily unit startup for the remainder of the seasonal startup.

System Restart After Extended Shutdown

NOTICE:

Equipment Damage!

Ensure that the compressor and oil sump heaters have been operating properly for a minimum of 24 hours before starting. Failure to do so could result in equipment damage.

Follow the procedures below to restart the unit after extended shutdown:

1. Verify that the liquid line service valves, oil line, compressor discharge service valves and suction service valves are open (backseated).

NOTICE:

Compressor Damage!

Catastrophic damage to the compressor will occur if the oil line shut off valve or the isolation valves are left closed on unit start-up.

2. Check the oil sump level.
3. Fill the evaporator water circuit. Vent the system while it is being filled. Open the vent on the top of the evaporator and condenser while filling and close when filling is completed.

NOTICE:

Proper Water Treatment!

The use of untreated or improperly treated water in this equipment could result in scaling, erosion, corrosion, algae or slime. It is recommended that the services of a qualified water treatment specialist be engaged to determine what water treatment, if any, is required. Trane assumes no responsibility for equipment failures which result from untreated or improperly treated water, or saline or brackish water.

4. Close the fused-disconnect switches that provides power to the chilled water pump.
5. Start the evaporator water pump and, while water is circulating, inspect all piping for leakage. Make any necessary repairs before starting the unit.
6. While the water is circulating, adjust the water flows and check the water pressure drops through the evaporator. See "[Evaporator Waterside Pressure Drop](#)," p. 35 and water flow rates in "[General Data](#)," p. 12.
7. Verify proper operation of flow switch on the evaporator waterbox.
8. Stop the water pump. The unit is now ready for start-up as described previously.

Sequence of Operation

This section will provide basic information on chiller operation for common events. With microelectronic controls, ladder diagrams cannot show today's complex logic, as the control functions are much more involved than older pneumatic or solid state controls.

Adaptive control algorithms can also complicate the exact sequence of operations. This section illustrates common control sequences.

Software Operation Overview

The Software Operation Overview shown below is a diagram of the five possible software states. This diagram can be thought of as a state chart, with the arrows and arrow text depicting the transitions between states.

Figure 68. Software operation overview

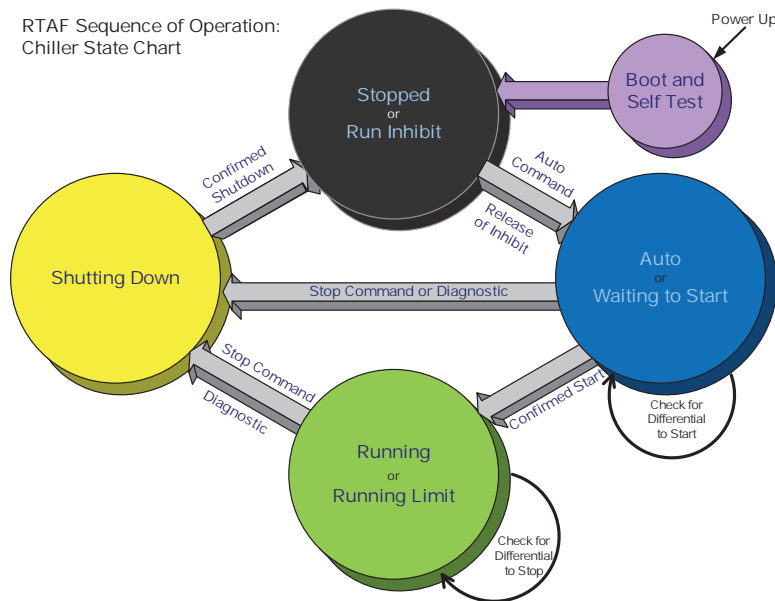

- The text in the circles is the visible top level operating mode displayed on Tracer™ AdaptiView.
- The shading of each software state circle corresponds to the shading on the time lines that show the state the chiller is in.

There are five generic states that the software can be in:

- Power Up
- Stopped
- Starting
- Running
- Stopping

Timelines

- The time line indicates the upper level operating mode, as it would be viewed on the Tracer AdaptiView.
- The shading color of the cylinder indicates the software state.
- Text in parentheses indicates sub-mode text as viewed on Tracer AdaptiView.
- Text above the time line cylinder is used to illustrate inputs to the Main Processor. This may include user input to the Tracer AdaptiView Touch screen, control inputs from sensors, or control inputs from a Generic BAS.
- Boxes indicate control actions such as turning on relays, or pulsing compressor load or unload solenoids.
- Smaller cylinders under the main cylinder indicate diagnostic checks.

- Text outside a box or cylinder indicates time based functions.
- Solid double arrows indicate fixed timers.
- Dashed double arrows indicate variable timers.

Important: *Sequence of events timelines include options that may not be available on specific unit configurations.*

Power Up Diagram

The figure below shows the respective TD-7 AdaptiView screens during a power up of the UC800 and display. This process takes 25 seconds for the UC800 and 90 seconds for the display. On all power ups, the software model always

will transition through the 'Stopped' Software state independent of the last mode. If the last mode before power down was 'Auto', the transition from 'Stopped' to 'Starting' occurs, but it is not apparent to the user.

Figure 69. Sequence of operation: power up diagram

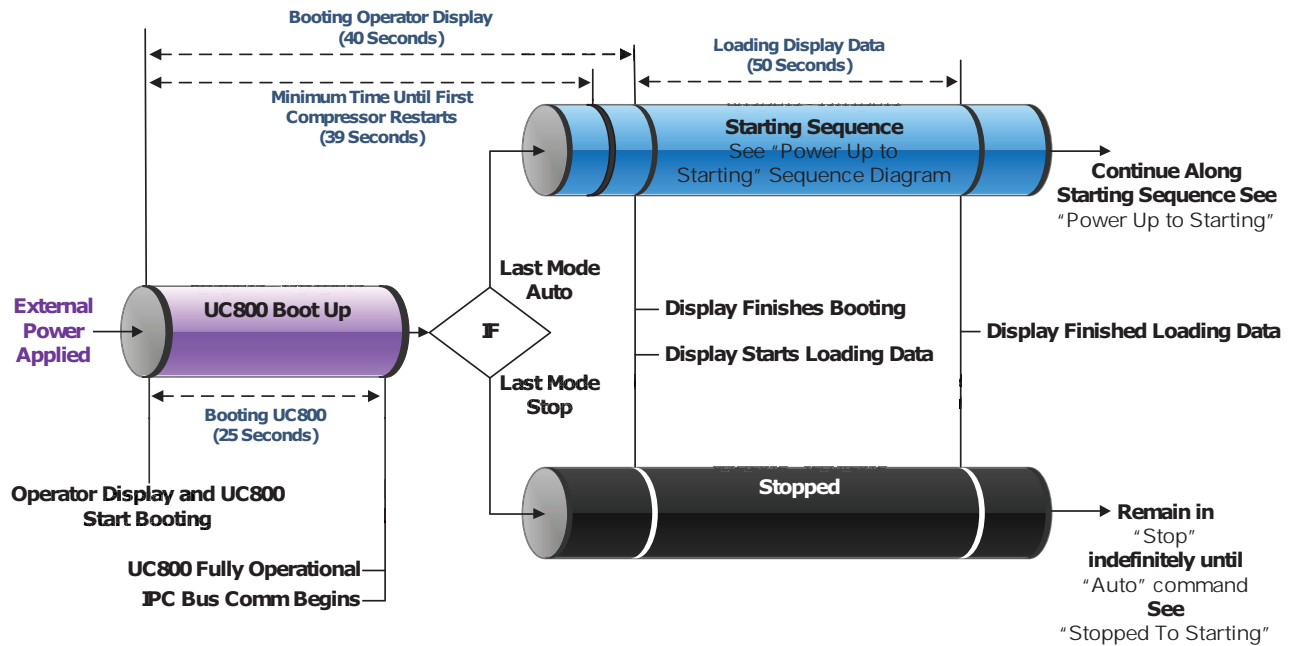

**Display will show either Auto or Stop button active once it is fully loaded*

Power Up to Starting

The figure below shows the timing from a power up event to energizing the first compressor. The shortest allowable time would be under the following conditions:

- No motor restart inhibit time left from subsequent starts
- Evaporator Water flow occurs quickly with pump on command
- Power up Start Delay set to 0 minutes

- Need to cool (differential to start) already exists
- Oil level is detected immediately

The above conditions would allow for a minimum power up to starting the first compressor time of about 45 seconds (variations may exist due to options installed). Note that it is not advisable to start a chiller "cold", the oil heaters should be in operation for a sufficient length of time prior to first start. Consult the chiller's IOM for specifics.

Figure 70. Sequence of events: power up to starting

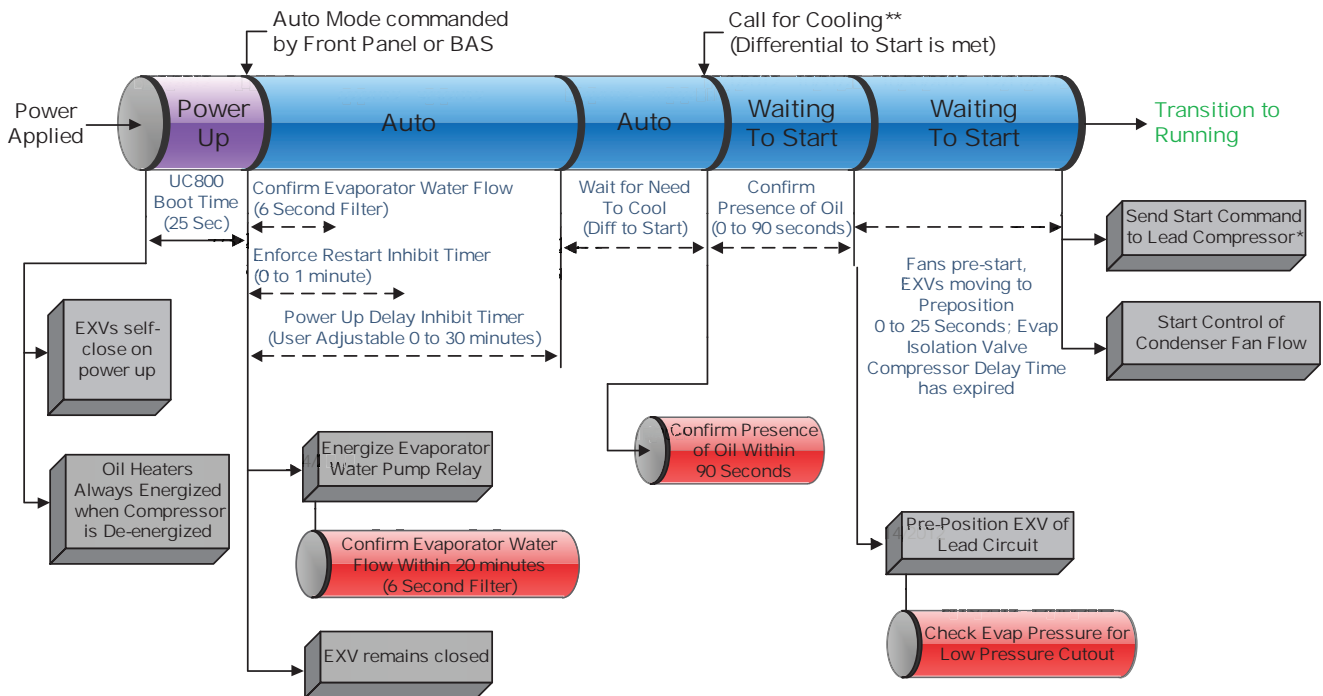

**If Free Cooling is available, it shall be the first level control to start.

Total Free Cooling: balanced starts and hours or circuit x lead are available. However, just like Partial Free Cooling, both compressors on a circuit should be running before starting the other circuit.

* Lead Compressor (and its lead circuit) is determined by staging algorithm – "Balanced", "Circuit 1 Lead", or "Circuit 2 Lead" selection – also influenced by lockouts, restart inhibit, or diagnostics present

Stopped to Starting

The figure below shows the timing from a stopped mode to energizing the first compressor. The shortest allowable time would be under the following conditions:

- No motor restart inhibit time left from subsequent starts

- Evaporator Water flow occurs quickly with pump on command
- Need to cool (differential to start) already exists

The above conditions would allow a compressor to start in about 20 seconds.

Figure 71. Sequence of events: stopped to starting

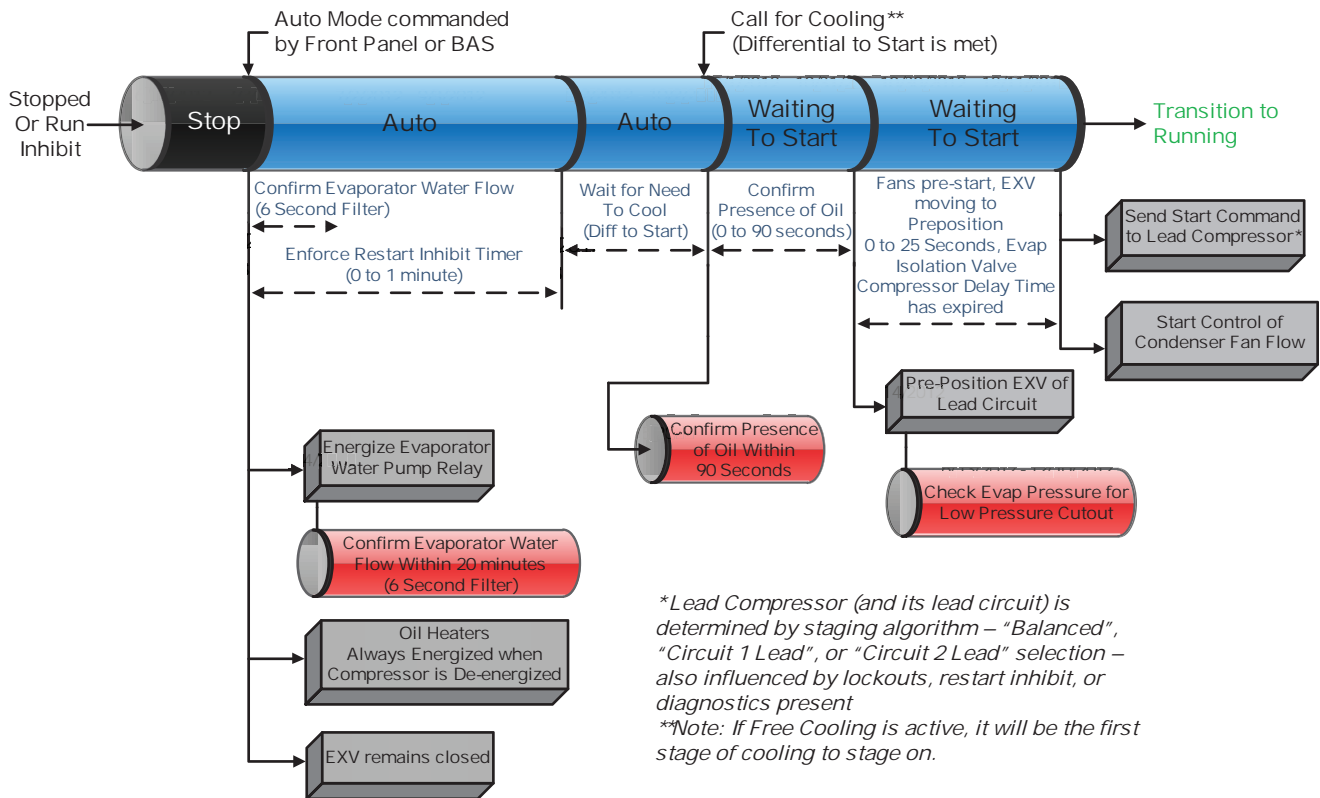

Running (Lead Compr/Circuit Start - Run)

The figure below shows a typical start and run sequence for the lead compressor and its circuit.

Figure 72. Sequence of operation: running (lead compressor/circuit start and run)

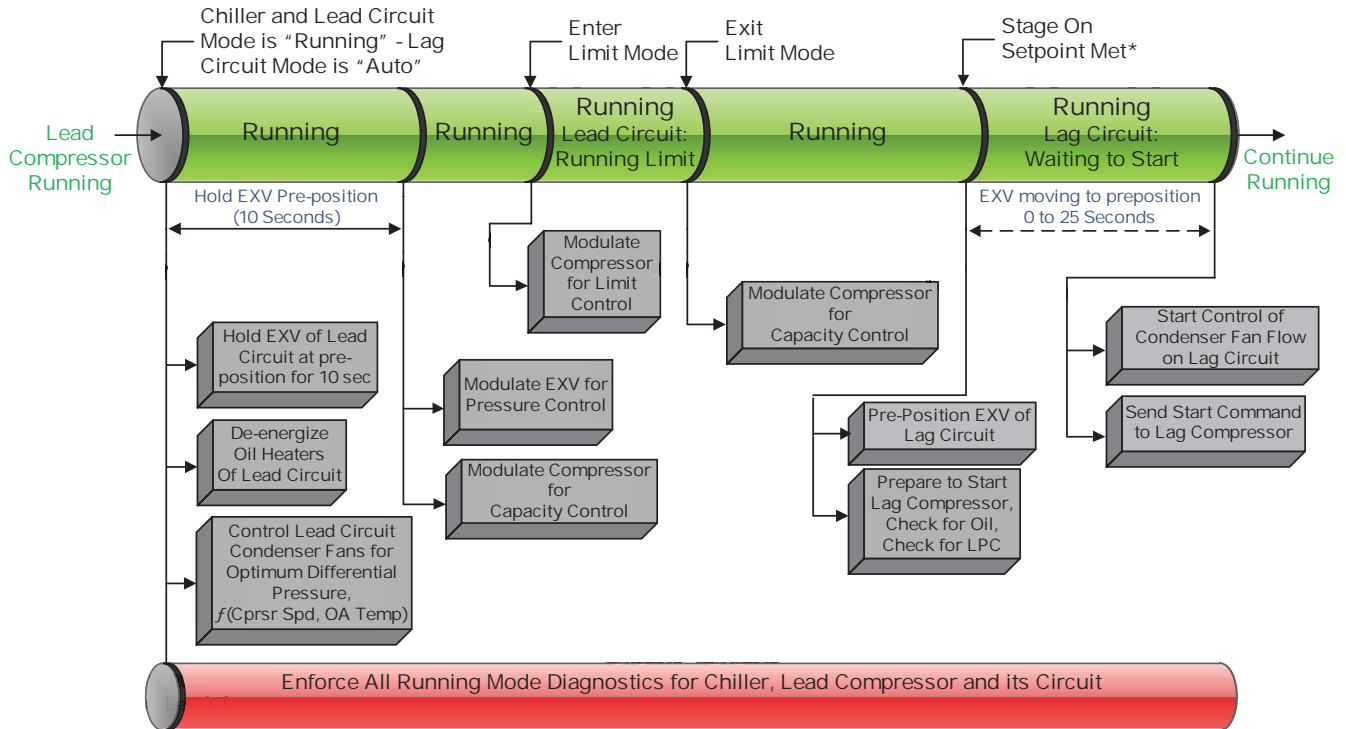

**Note: The decision to stage on or off another compressor is determined by the Average Running Compressor Load Command, Water Temperature Error, and Time Since Last Stage Circuit X Lead: A compressor on the selected circuit will lead followed by a compressor on the alternate circuit, given an appropriately increasing chiller load. Additional compressors will alternate between lead and lag circuits. Variable speed compressors will always be the first compressors to start and last compressors to stop.*

Running (Lag Compr/Circuit Start - Run)

The figure below shows a typical start and run sequence for the lag compressor and its circuit.

Figure 73. Sequence of operation: running (lag compressor/circuit start and run)

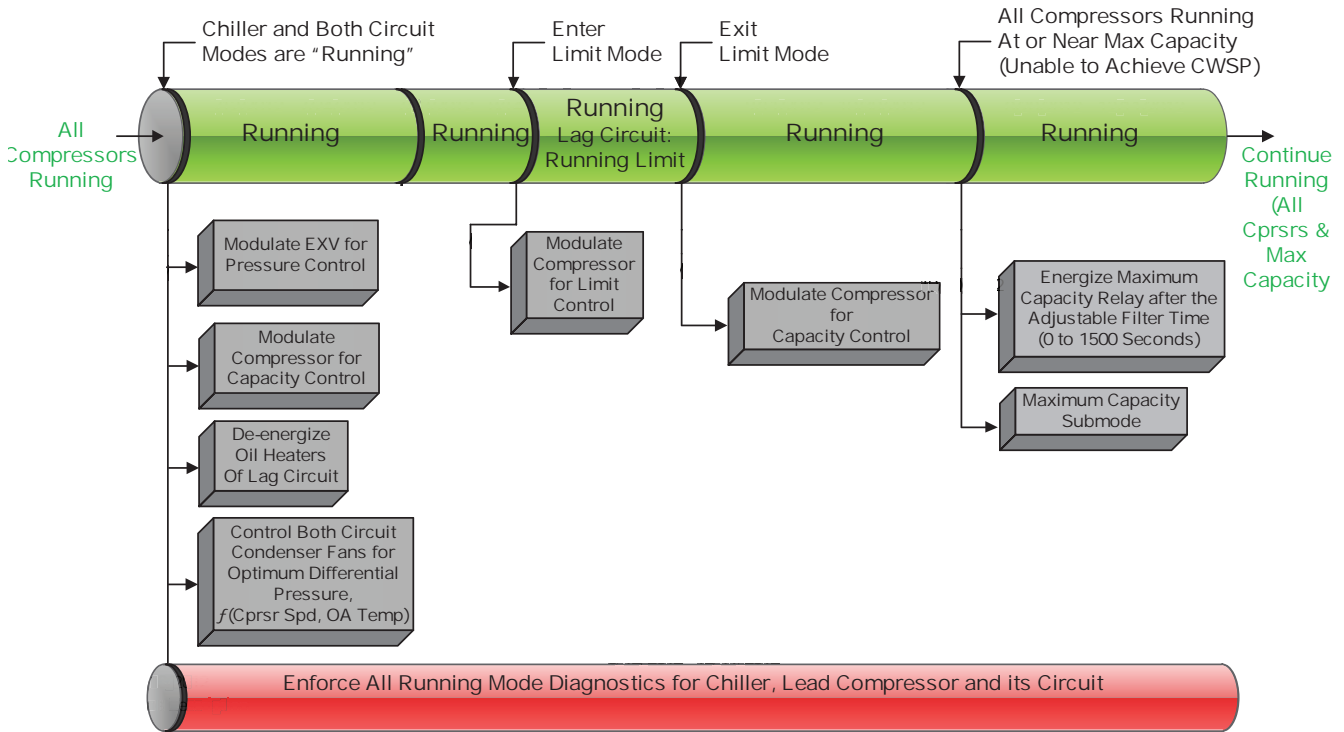

**Note: The decision to stage on or off another compressor is determined by the Average Running Compressor Load Command, Water Temperature Error, and Time Since Last Stage*

Satisfied Setpoint

The figure below shows the normal transition from Running to shutting down due to the Evap Leaving water temp falling below the differential to stop setpoint.

Figure 74. Sequence of events: satisfied setpoint

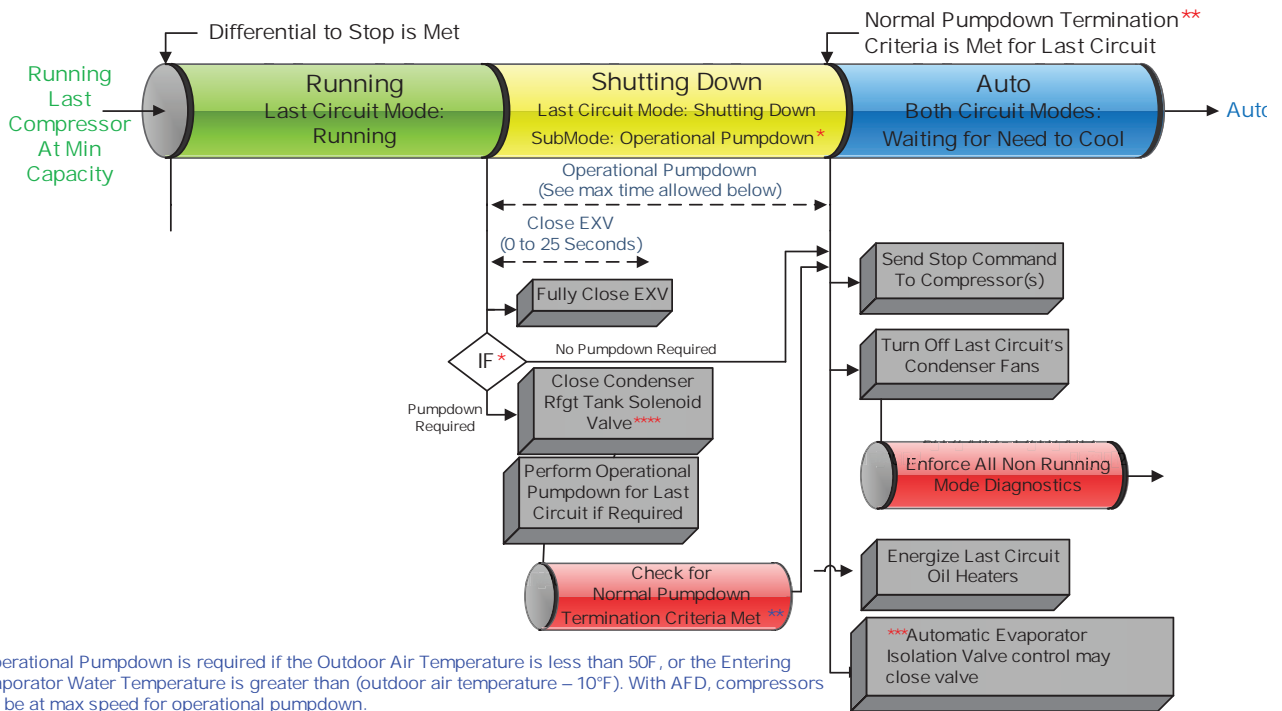

*Operational Pumpdown is required if the Outdoor Air Temperature is less than 50F, or the Entering Evaporator Water Temperature is greater than (outdoor air temperature – 10°F). With AFD, compressors will be at max speed for operational pumpdown.

** Operational pumpdown is terminated normally in the following configurations when:

Water with 2-Pass Evaporator:

- The evaporator (suction) pressure is at or below the "Pumpdown Termination Pressure" setting OR LERTC saturated pressure (28.6F), which ever is greater
- The condenser (compressor discharge) pressure exceeds 315psia.
- The compressor pressure ratio exceeds 8.
- The system differential pressure exceeds 265psid or <25min.

Glycol with 2-Pass Evaporator:

- The evaporator (suction) pressure is at or below the "Pumpdown Termination Pressure" setting OR LERTC saturated pressure (per guidance -5F minimum), which ever is greater
- The condenser (compressor discharge) pressure exceeds 315psia.
- The compressor pressure ratio exceeds 8.
- The system differential pressure exceeds 265psid or <25min.

Water with Single Pass Evaporator:

- The evaporator (suction) pressure is at or below the "Pumpdown Termination Pressure" setting OR LERTC saturated pressure (32F), which ever is greater
- The condenser (compressor discharge) pressure exceeds 315psia.
- The compressor pressure ratio exceeds 12.3
- The system differential pressure exceeds 265psid.

Glycol with Single Pass Evaporator:

- The evaporator (suction) pressure is at or below the "Pumpdown Termination Pressure" setting OR LERTC saturated pressure (per guidance -5F minimum), which ever is greater
- The condenser (compressor discharge) pressure exceeds 315psia.
- The compressor pressure ratio exceeds 12.3
- The system differential pressure exceeds 265psid.

The maximum allowed time for Operational Pumpdown is Max Pumpdown Time setting (default to 120 sec.) * number of compressors configured on the circuit.

***Automatic evaporator isolation valve control will close valve if Outdoor Ambient Air Temperature at circuit shutdown is less than evaporator leaving water cutout setpoint plus 3°C.

****If Condenser Refrigerant Tanks are installed

Unloading Unstaging

The figure below shows the normal transition from full load to minimum load while the chiller is running.

Figure 75. Sequence of events: unloading unstaging

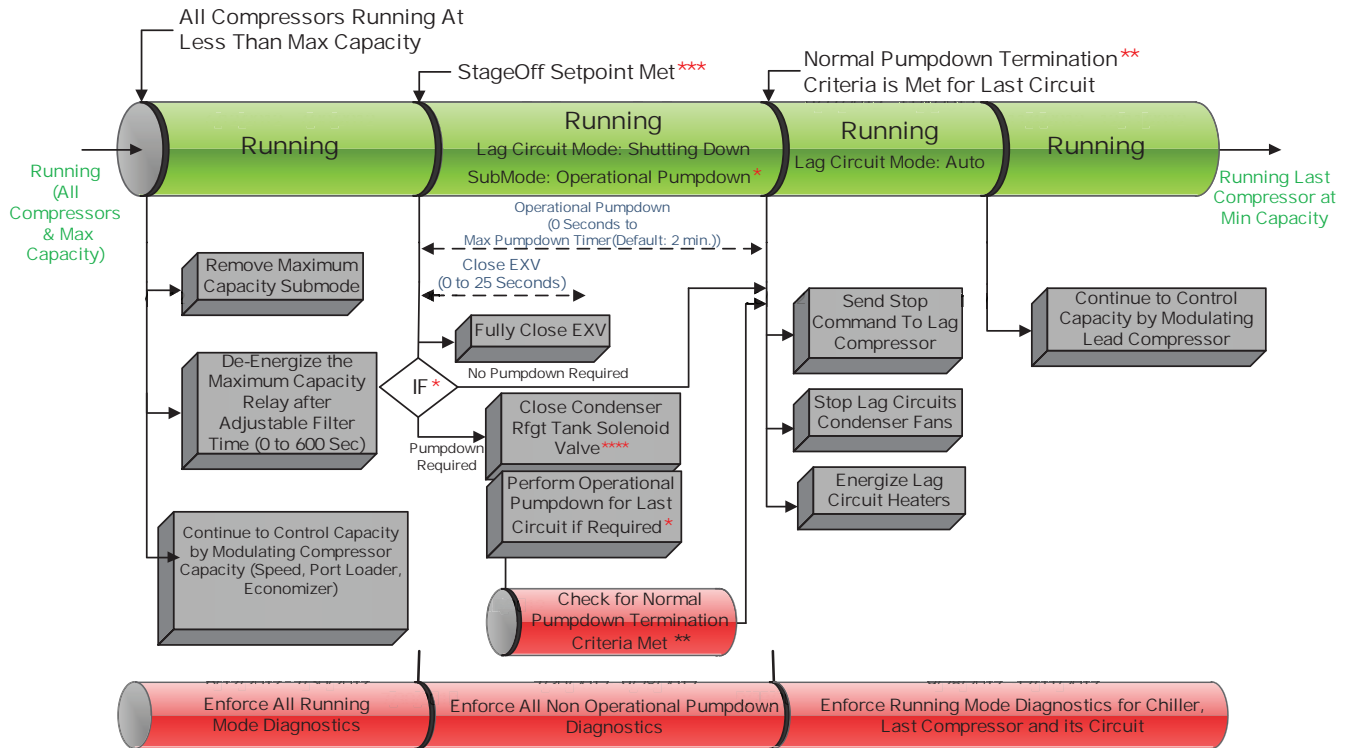

* Operational Pumpdown is required if the Outdoor Air Temperature is less than 50F, or the Entering Evaporator Water Temperature is greater than (outdoor air temperature – 10F). With AFD, compressors will be at max speed for operational pumpdown.

**Operational Pumpdown - See Satisfied Setpoint Operational Pumpdown sequence diagram for specific criteria.

*** Note: The decision to stage off another compressor is determined by the Average Running Compressor Load Command, Water Temperature Error, and Time since Last Stage. Compressors will stage off in the reverse order they staged on. All fixed speed compressors will stage off before variable speed compressors stage off.

**** If Condenser Refrigerant Tank is installed.

Normal Shutdown to Stopped or Run Inhibit

The figure below shows the Transition from Running through a Normal (friendly) Shutdown. The Dashed lines on the top attempt to show the final mode if you enter the stop via various inputs.

Figure 76. Sequence of events: normal shutdown to stopped or run inhibit

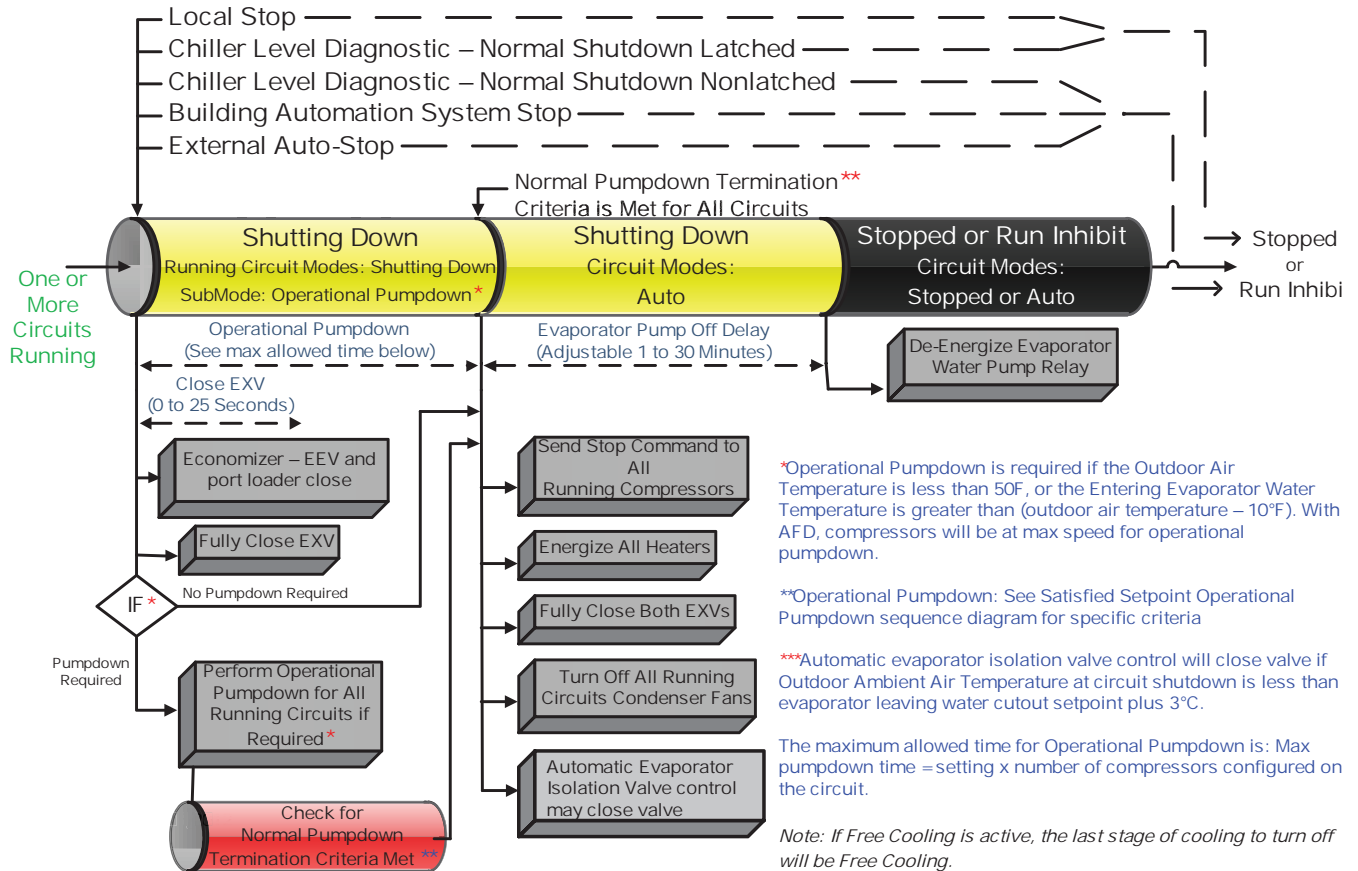

Immediate Shutdown to Stopped or Run Inhibit

The figure below shows the transition from Running through an Immediate Shutdown. The dashed lines on the top attempt to show the final mode if you enter the stop via various inputs.

Figure 77. Sequence of events: immediate shutdown to stopped or run inhibit

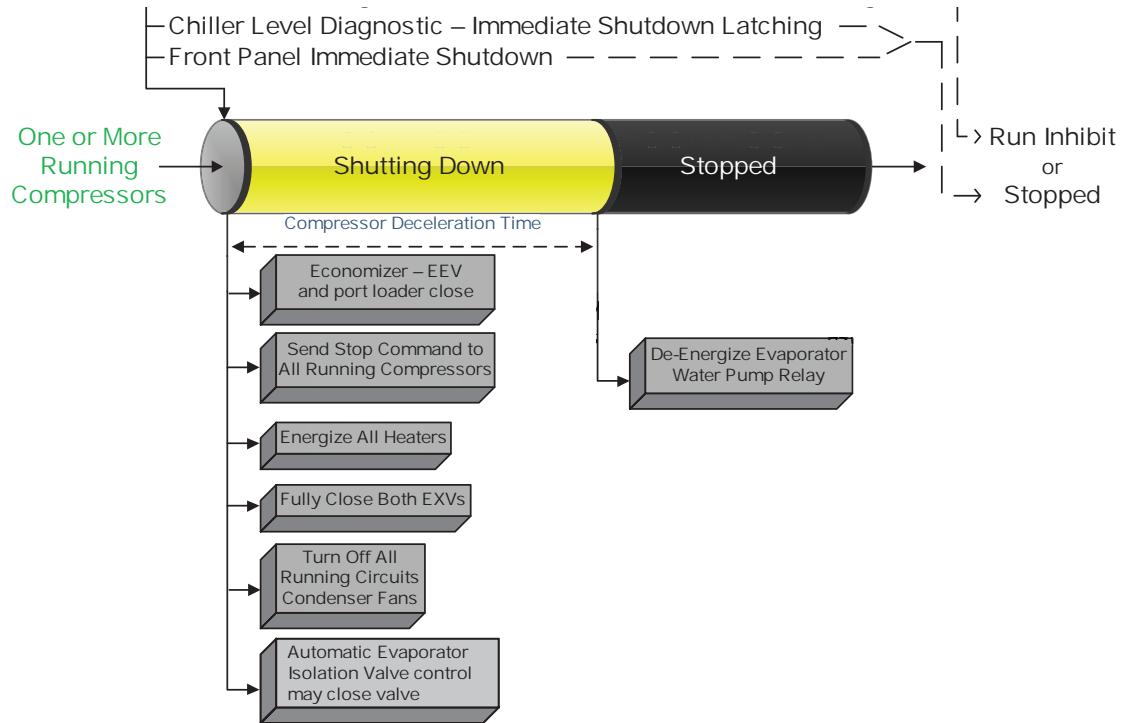

Ice Making (Running to Ice Making to Running)

The figure below shows the transition from normal cooling to Ice making, back to normal cooling.

Figure 78. Sequence of events: ice making (running to ice making to running)

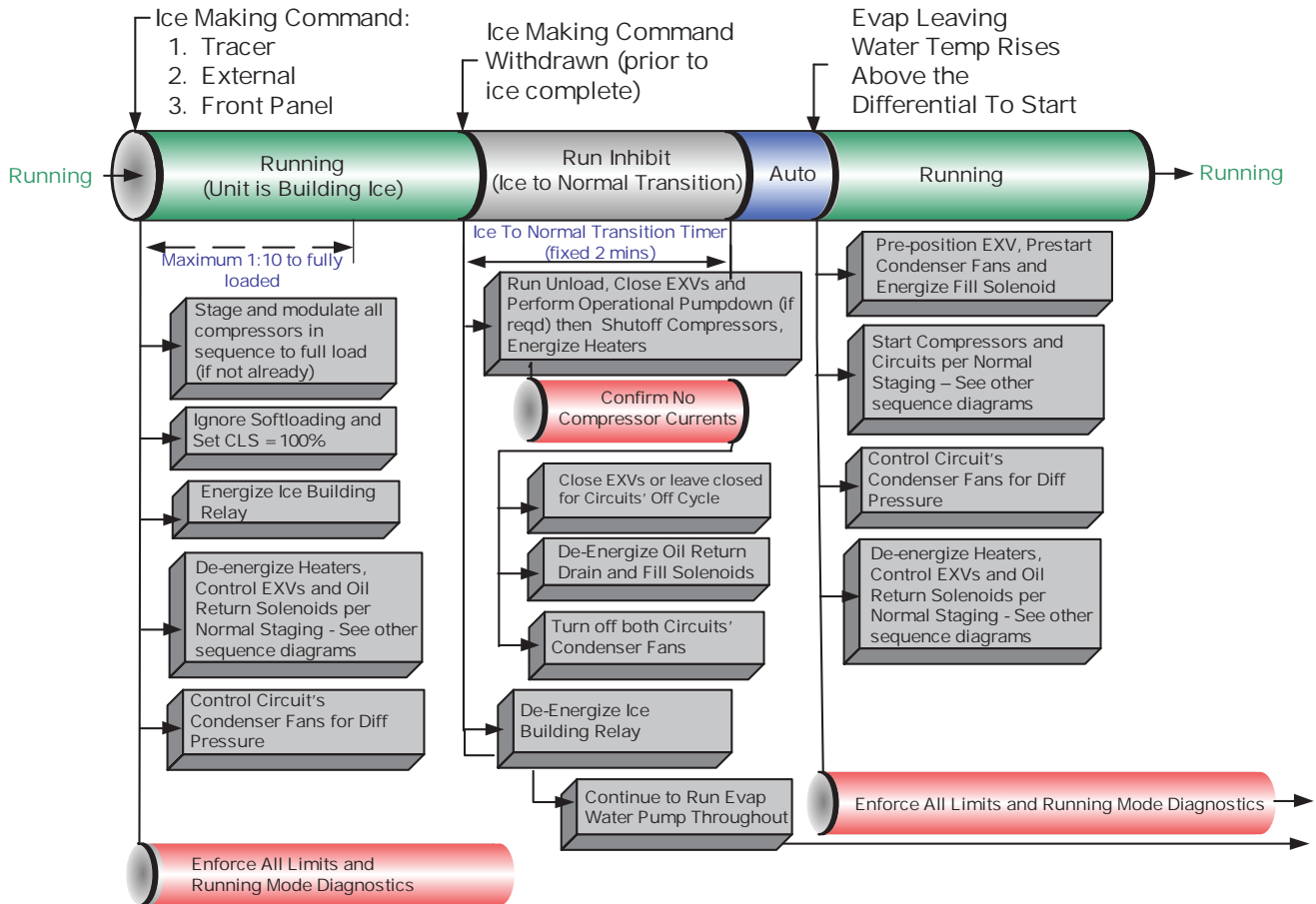

Ice Making (Auto to Ice Making to Ice Making Complete)

The figure below shows the transition from Auto to ice making, to Ice Making Complete.

Figure 79. Sequence of events: ice making (auto to ice making to ice making complete)

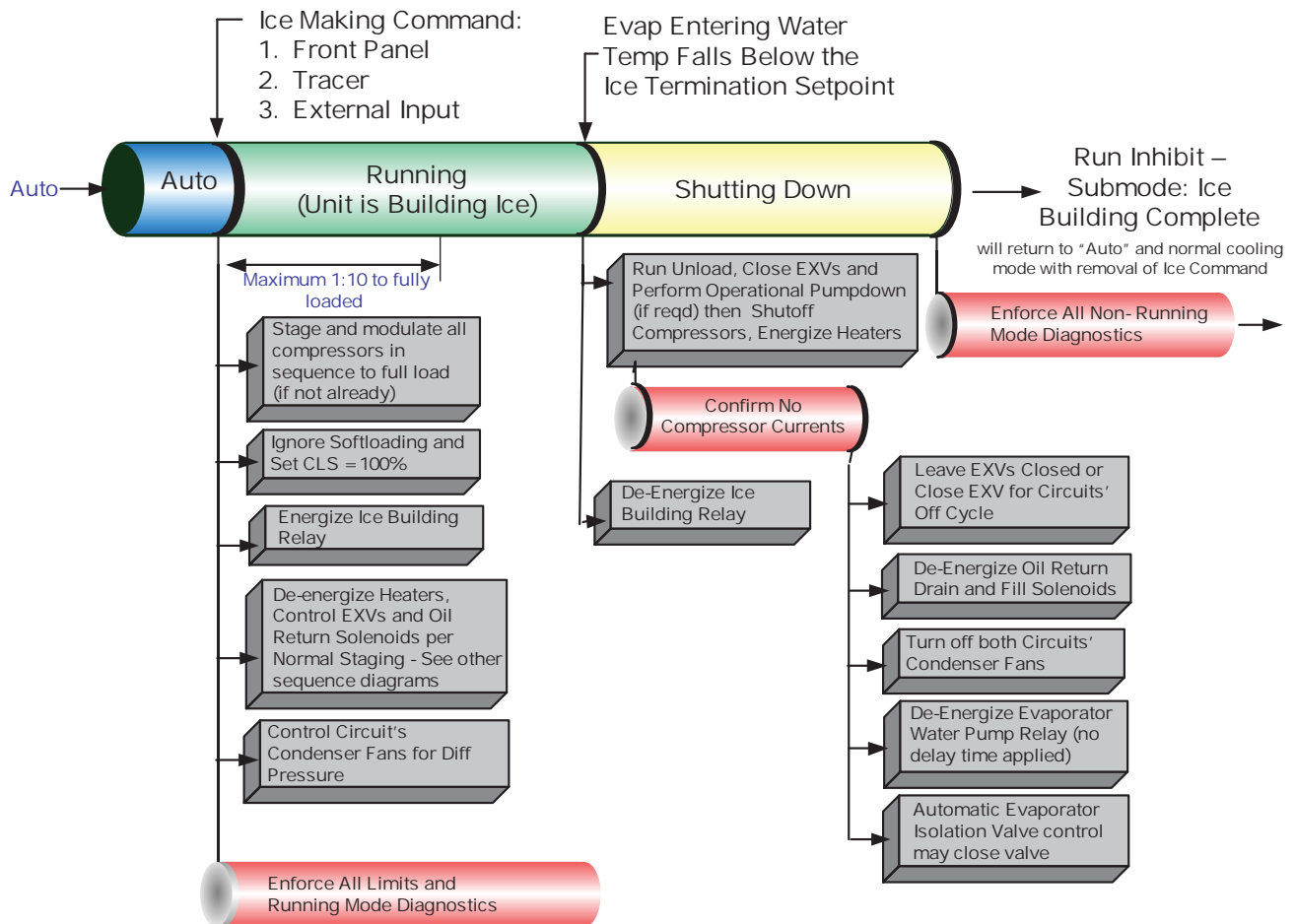



Maintenance

⚠ WARNING

Hazardous Voltage w/Capacitors!

Failure to disconnect power and discharge capacitors before servicing could result in death or serious injury. Disconnect all electric power, including remote disconnects and discharge all motor start/run capacitors before servicing. Follow proper lockout/tagout procedures to ensure the power cannot be inadvertently energized. For variable frequency drives or other energy storing components provided by Trane or others, refer to the appropriate manufacturer's literature for allowable waiting periods for discharge of capacitors. Verify with an appropriate voltmeter that all capacitors have discharged.

For additional information regarding the safe discharge of capacitors, see PROD-SVB06*-EN.

This section describes the basic chiller preventive maintenance procedures, and recommends the intervals at which these procedures should be performed. Use of a periodic maintenance program is important to ensure the best possible performance and efficiency from a Sintesis™ chiller.

Use Operator Log in Log and Check Sheet chapter to record an operating history for unit. The log serves as a valuable diagnostic tool for service personnel. By observing trends in operating conditions, an operator can anticipate and prevent problem situations.

If unit does not operate properly during inspections, see Diagnostics chapter.

Recommended Maintenance

Perform all maintenance procedures and inspections at the recommended intervals. This will increase the life of the chiller and minimize the possibility of costly failures.

Weekly

- At AdaptiView™ TD7 or Tracer™ TU service tool, check pressure for evaporator, condenser and intermediate oil.
- Observe liquid line sight glass on EXV. If liquid line sight glass has bubbles measure the subcooling entering the EXV. Subcooling should always be greater than 10°F.

Important: A clear sight glass alone does not mean that the system is properly charged. Also check the rest of the system operating conditions.

- Inspect the entire system for unusual operation.
- Inspect the condenser coils for dirt and debris. If the coils are dirty, see "Microchannel Condenser Coils," p. 92.

NOTICE:

Coil Damage!

Do not use detergents to clean coils. Use clean water only. Use of detergents on coils could cause damage to coils.

- Ensure exterior of panel enclosures (including remote VFD, if installed) are clear of any dust or debris.

Important: Panel cooling air lets must be regularly inspected and kept clean and free of debris. Failure to do so can cause reduced cooling to drives, resulting in unit trips on drive over-temperature.

Monthly

- Perform all weekly maintenance procedures.
- Record the system subcooling.
- Record the system superheat.
- Make any repairs necessary.

Annual

- Perform all weekly and monthly procedures
- Check the oil level while the unit is off. See "Oil Sump Level Check," p. 91.
 - Routine changing of the oil is not required. Make an oil analysis to determine the condition of the oil.
- Have Trane or another qualified laboratory perform a compressor oil analysis to determine system moisture content and acid level.
- Contact a qualified service organization to leak-test the chiller, to check operating and safety controls, and to inspect electrical components for deficiencies
- Clean and repaint any areas that show signs of corrosion.
- Clean the condenser coils. See "Microchannel Condenser Coils," p. 92.

NOTICE:

Coil Damage!

Do not use detergents to clean coils. Use clean water only. Use of detergents on coils could cause damage to coils.

- Clean the air filters in the bottom inlet hoods that extend from the back of the electrical panel.
- Check and tighten all electrical connections as necessary.

Refrigerant and Oil Charge Management

Proper oil and refrigerant charge is essential for proper unit operation, unit performances, and environmental protection. Only trained and licensed service personnel should service the chiller.

Table below lists baseline measurements for Sintesis™ units running at AHRI standard operating conditions. If chiller measurements vary significantly from values listed below, problems may exist with refrigerant and oil charge levels. Contact your local Trane office.

Note: *Low temperature applications units will have values that vary from the table below. Contact your local Trane office for more information.*

Table 41. Typical Sintesis baselines (AHRI conditions)

Measurement	Baseline
Evaporator Pressure	50.5 psia
Evaporator Approach	3°F
EXV Position	45% open
Evaporator Fluid delta T - entering	54°F
Evaporator Fluid delta T - leaving	44°F
Discharge Superheat	25°F
Condenser Pressure	195 psia
Subcooling	18°F

Lubrication System

Oil Sump Level Check

Figure 80. Oil sump level check

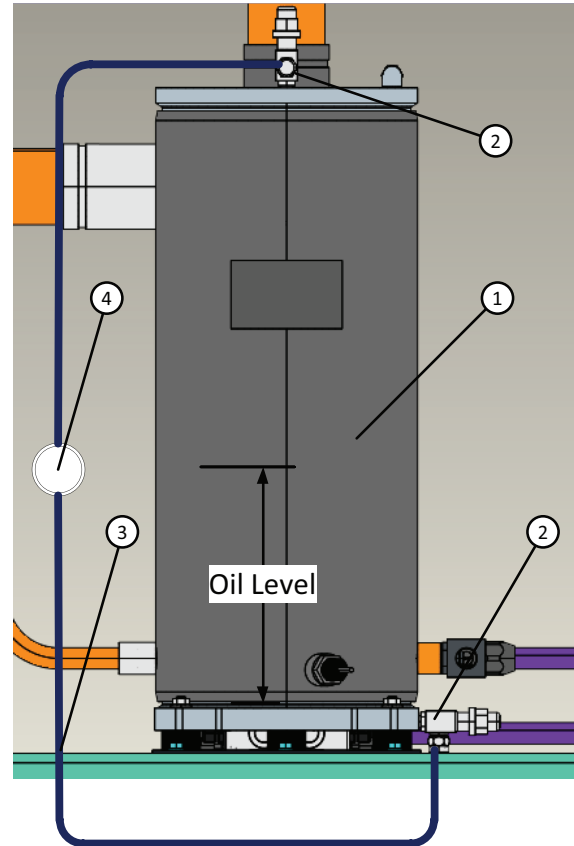

1	Oil Separator	3	Refrigeration hose
2	Valves	4	Sight Glass

The oil level in the sump can be measured to give an indication of the system oil charge. Follow the procedures below to measure the level.

1. Run the unit as near to full load as possible for a minimum of 30 minutes. For an accurate reading, 40 or more minutes at full load with normal/steady discharge superheat readings and no limits/warnings is recommended. Assessing oil charge after running at minimum or low loads may lead to an inaccurate reading.
2. Cycle the compressor offline.
3. Let the chiller sit (powered, but offline) to allow the oil separator heater to boil off the refrigerant that may be in the oil separator. An initial assessment of the oil separator level may be made after heater has been ON for 30 minutes, but oil charge adjustments should not be made without allowing the oil heaters to run for a minimum of 4 hours.



Maintenance

Important: Do not operate the unit with the sight glass service valves opened. Close the valves while running before and after checking the oil level. Oil system function may be affected and level reading will not be accurate during operation if valves are opened during operation.

- Attach a 3/8" or 1/2" hose with a sightglass in the middle to the oil sump service valve (3/8" flare) and the oil separator service valve (3/8" flare). See [Figure 80, p. 91](#) for valve locations.

Note: Using high pressure rated clear hose with appropriate fittings can help speed up the process. Hose must be rated to withstand system pressures as found on unit nameplate.

- After the unit is off line for 30 minutes, move the sightglass along the side of the oil sump.
- The nominal oil level from the bottom of the oil separator should be approximately within the range shown in the table below. Depending on running conditions and the time the oil heater has been on, some deviation from nominal levels is expected.

Important: If level is outside range shown in table below, contact your local Trane office.

Table 42. Nominal oil levels

Unit Sizes	Ckt	Minimum		Maximum	
		in	mm	in	mm
115, 130, 150, 170, 180	1, 2	2	50	4.5	115
200	2				
200	1	2	50	5.5	140
215, 230, 250, 270	1, 2				
280, 310, 350, 390	2	2	50	6	150
280, 310, 350, 390	1				
410, 450, 500, 520	1, 2				

Travel Restraint

⚠ WARNING

Falling Off Equipment!

Failure to use travel restraint slots and equipment could result in individual falling off the unit which could result in death or serious injury. This unit is built with travel restraint slots located on unit top that **MUST** be used during servicing. These slots are to be used with travel restraint equipment that will not allow an individual to reach the unit edge. However such equipment will **NOT** prevent falling to the ground, for they are **NOT** designed to withstand the force of a falling individual.

This unit is built with travel restraint slots located on unit top that must be used during servicing.

Microchannel Condenser Coils

For proper operation, microchannel condenser coils must be cleaned regularly. Eliminate pollution and other residual material help to extend the life of the coils and the unit.

Regular coil maintenance, including annual cleaning, enhances the unit's operating efficiency by minimizing compressor head pressure and amperage draw. The condenser coil should be cleaned at minimum once each year, or more if the unit is located in a "dirty" or corrosive environment.

Coil Cleaning

NOTICE:

Coil Damage!

Do not use detergents to clean coils. Use clean water only. Use of detergents on coils could cause damage to coils.

Cleaning with cleansers or detergents is strongly discouraged due to the all-aluminum construction. Water should prove sufficient. Any breach in the tubes can result in refrigerant leaks.

⚠ WARNING

Hazardous Voltage w/Capacitors!

Failure to disconnect power and discharge capacitors before servicing could result in death or serious injury. Disconnect all electric power, including remote disconnects and discharge all motor start/run capacitors before servicing. Follow proper lockout/tagout procedures to ensure the power cannot be inadvertently energized. For variable frequency drives or other energy storing components provided by Trane or others, refer to the appropriate manufacturer's literature for allowable waiting periods for discharge of capacitors. Verify with an appropriate voltmeter that all capacitors have discharged.

For additional information regarding the safe discharge of capacitors, see *PROD-SVB06*-EN*.

- Disconnect Power to the unit.
- Use a soft brush or vacuum to remove base debris or surface loaded fibers from both sides of the coil.

Note: When possible, clean the coil from the opposite direction of normal air flow (inside of unit out) to push debris out.

- Using a sprayer and water **ONLY**, clean the coil following the guidelines below.
 - Sprayer nozzle pressure should not exceed 580 psi.
 - The maximum source angle should not exceed 25° to the face of the coil. See figure below. For best results spray the microchannel perpendicular to face of the coil.

- c. Spray nozzle should be approximately 1" - 3" from the coil surface.
- d. Use at least a 15° fan type of spray nozzle.

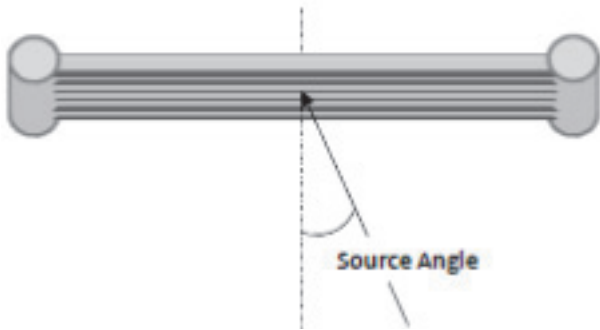
Figure 81. Sprayer source angle

Note: To avoid damage from the spray wand contacting the coil, make sure the 90° attachment does not come in contact with the tube and fin as abrasion to the coil could result.

Free-Cooling Option Maintenance

Free-Cooling Coil Cleaning

Follow coil cleaning procedures found in [Figure , p. 92](#) for free-cooling microchannel coils.

Free-Cooling By-Pass Valve Adjustment

For intervention on free-cooling by-pass valve it is recommended to consult the valve service literature. For every new referencing of the motor end travel, an adaptation of the motor should be done by pushing button 2. To change the bypass percentage, follow procedure below:

- No tuning is needed on free cooling valve which always stays on full open/close.
- For Belimo bypass valve, minimum opening can be adjusted by pushing the release button (4) and by turning handle 5 to 50% opening for instance (45°).

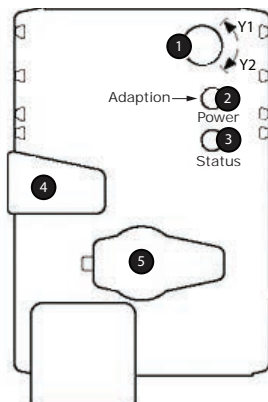
Figure 82. Belimo operating controls and indicators

Table 43. Belimo operating controls descriptions

Ref	Description	Setting	Action
1	Direction of Rotation Switch	Switch Over	Direction of Rotation Change
2	Push-button and LED display (green)	Off	No power supply or malfunction
		On	In operation
		Press Button	Triggers angle of rotation adaption, followed by standard mode.
3	Push-button and LED display (yellow)	Off	Standard mode
		On	Adaptation or synchronizing process active
		Press Button	No function
4	Gear disengagement button	Press Button	Gear disengages, motor stops, manual override possible
		Release Button	Gear engages, synchronization starts, followed by standard mode
5	Service Plug		For connecting parameterization and service tools.
2 and 3	Check Power Supply Connection	2 Off and 3 On	Possible wiring error in power supply

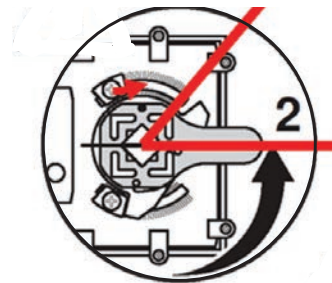
Use a Phillips screwdriver to make adjustments. Setting should keep an opening between minimum desired, and 100%. See figure below for an example with 50% setting.

Figure 83. By-pass valve setting

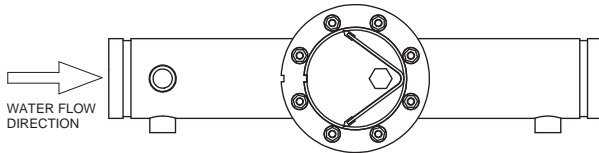
Figure 84. By-pass valve setting photo

If the minimum opening is modified after unit start-up, motor recalibration is needed to validate new operating range. When motor is powered, push green LED button (2). Motor memorizes the new reference of end of travel position on its signal (2-10 VDC).

Water Strainer
Figure 85. In-line strainer

The water strainer is factory-installed with taps for pressure gauges on the inlet and outlet. For maximum efficiency, a differential pressure gauge installed across the inlet and outlet will indicate pressure loss due to clogging and may be used as a guide to determine when cleaning is required.

To determine if strainer requires cleaning, install pressure gauges across inlet and outlet of strainer, and measure pressure differential. Normally, when differential pressure reaches 5-10 psi, the screen must be cleaned as follows:

1. Isolate the strainer by ensuring free-cooling service shut-off valve and modulating valve 6M4 are closed.
2. Open strainer cover and remove screen.
3. Clean out strainer screen until all sediment is removed.
4. Replace screen and reinstall cover.

Free-Cooling Fluid Management
NOTICE:
Equipment Damage!

Failure to follow instructions below could cause equipment damage.

DO NOT USE UNTREATED WATER. Glycol solution must be utilized with the Direct Free Cooling option. Glycol percentage should be based on freeze avoidance requirements. The glycol solution requires an inhibitor package to be carefully chosen with the aid of a qualified water treatment specialist to abate corrosion in a mixed metal system.

The building glycol loop should not be vented to atmosphere. A closed system is required to limit oxidation potential within the loop.

Make-up water should be avoided.

NOTICE:
Coil Damage!

Failure to follow instructions below could result in free-cooling coil freeze.

For units with free-cooling option, introduction of uninhibited water into the system is not recommended, as it could lead to internal corrosion and risk of coil freeze. To avoid free-cooling coil damage:

- If the building loop needs to be charged with water for testing purposes, isolate free-cooling coils by closing free-cooling service shut-off valve and modulating valve 6M4.
- Completely drain any water inadvertently introduced into the system, and replace with glycol fluid as required for the free-cooling system.
- If water was introduced for hydronic testing, and was not immediately replaced with glycol solution, a glycol (freeze inhibitor) solution must be introduced to the free-cooling system/coils for any long term storage.

The direct free cooling option circuit consists of copper, carbon steel, cast iron, zinc, EPDM rubber, brass, and Aluminum AA3102, AA3003, AA4045 in addition to other materials that may be in the building loop connected to the chiller. The inhibited glycol solution should be selected at desired concentration to insure adequate inhibitor content. It is not advised to dilute a stronger concentrate due to inhibitor dilution. Glycol fluid should be free from foreign solid particles. A maintenance schedule should be selected per the glycol manufacturer's requirements to insure adequate protection during product usage.



Diagnostics

Diagnostic Name (Text) and Source:

Black text is the full-context diagnostic name with few or no abbreviations. It has no intrinsic length limit. It may be used as a guide for translation, or in a human interface that can handle the unlimited length text. It is not currently used in any human interface.

Where diagnostic text is different from full-context diagnostic name:

- **Italicized** text is intended for use on the Service Tool or on the operator Display.
- **Underlined** text is intended for use on LCI-C.

Diagnostic Name Source: Diagnostics may be shown in the spec with a source of “xy”. In this case, letter “x” can be either “1” or “2” (signifying which circuit) and letter “y” can be “A” or “B” (signifying which compressor on that circuit).

Affects Target: Defines the “target” or what is affected by the diagnostic. Usually either the entire Chiller, or a particular Circuit or Compressor is affected by the diagnostic (the same one as the source), but in special cases functions are modified or disabled by the diagnostic. None implies that there is no direct affect to the chiller, sub components or functional operation.

Design Note: TU does not support the display of certain targets on its Diagnostics pages although the functionality implied by this table is supported. Targets such as Evap Pump, Ice Mode, Heat Mode, Chilled Water Reset, External Setpoints etc. – are displayed as simply “Chiller” even though they do not imply a chiller shutdown – only a compromise of the specific feature.

Severity: Defines the severity of the above effect. Immediate means immediate shutdown of the affected portion; for AFD generated diagnostics, Immediate implies immediately de-energized compressor windings, while Immediate (decel) implies controlled deceleration to compressor stop. Normal means normal or friendly shutdown of the affected portion, Special Action means a special action or mode of operation (limp along) is invoked, but without shutdown, and Info means an Informational Note or Warning is generated. Design Note: TU does not support display of “Special Action”, on its Diagnostics pages, so that if a diagnostic has a special action defined in the table below, it will be displayed only as “Informational Warning” as long as no circuit or chiller shutdown results. If there is a shutdown and special action defined in the table, then the TU Diagnostics Page display will indicate the shutdown type only.

Persistence: Defines whether or not the diagnostic and its effects are to be manually reset (Latched), or can be either manually or automatically reset when and if the condition returns to normal (Nonlatched).

Active Modes [Inactive Modes]: States the modes or periods of operation that the diagnostic is active in and, as necessary, those modes or periods that it is specifically

“not active” in as an exception to the active modes. The inactive modes are enclosed in brackets, []. Note that the modes used in this column are internal and not generally announced to any of the formal mode displays.

Criteria: Quantitatively defines the criteria used in generating the diagnostic and, if nonlatching, the criteria for auto reset. If more explanation is necessary a hot link to the Functional Specification is used.

Reset Level: Defines the lowest level of manual diagnostic reset command which can clear the diagnostic. The manual diagnostic reset levels in order of priority are: Local or Remote. For example, a diagnostic that has a reset level of Remote, can be reset by either a remote diagnostic reset command or by a local diagnostic reset command.

Help Text: Provides for a brief description of what kind of problems might cause this diagnostic to occur. Both control system component related problems as well as chiller application related problems are addressed (as can possibly be anticipated). These help messages will be updated with accumulated field experience with the chillers.

AFD Diagnostics

Table 44. AFD diagnostics

Diagnostic Name and Source	Affects Target	Severity	Persistence	Active Modes [Inactive Modes]	Criteria	Reset Level
AFD Fault - xA	Cprsr	Immediate	NonLatch	All	AFD Fault. Numerous drive faults can cause this general fault including High Pressure Cutout for AFD compressors.	Local
AFD Motor Current Overload - xA	Circuit	Immediate	Latch	All	Compressor current exceeded overload time vs. trip characteristic. Must trip = 132% RLA, Must hold=125%	Local
AFD Interrupt Failure - xA	Chiller	Immediate Shutdown and Special Action	Latch	AFD Intended to be OFF	Respective AFD is reporting that it is still running the compressor when the MP has commanded the drive/compressor to be Off. Detection time shall be 10 seconds minimum and 15 seconds maximum. On detection and until the controller is manually reset: this diagnostic shall be active and the alarm relay shall be energized, the Evap Pump Output will be energized, the effected compressor will be continually commanded off, and be unloaded, while a normal stop shall be commanded to all other compressors. For as long as compressor operation continues, the MP shall continue oil return and fan control on the circuit affected. During contactor interrupt failure, circuit will not be confirmed off, so THR unit sequence should continue running. If THR turns off due to a diagnostic or lockout during contactor interrupt failure, the circuit reverts to air-cooled condenser fan control within 1 second.	Local

Starter Diagnostics

Table 45. Starter diagnostics

Diagnostic Name and Source	Affects Target	Severity	Persistence	Active Modes [Inactive Modes]	Criteria	Reset Level
Motor Current Overload - xy	Circuit	Immediate	Latch	Cprsr Energized	Compressor current exceeded overload time vs. trip characteristic. Must trip = 140% RLA, Must hold=125%, nominal trip 132.5% in 30 seconds	Local
Over Voltage	Chiller	Normal	NonLatch	Pre-Start and Any Ckt(s) Energzd	Nom. trip: 60 seconds at greater than 112.5%, ? 2.5%, Auto Reset at 110% or less for 10 cont secs.	Remote
Phase Loss - xy	Cprsr	Immediate	Latch	Start Sequence and Run modes	a) No current was sensed on one or two of the current transformer inputs while running or starting (See Nonlatching Power Loss Diagnostic for all three phases lost while running). Must hold = 20% RLA. Must trip = 5% RLA. Time to trip shall be longer than guaranteed reset on Starter Module at a minimum, 3 seconds maximum. Actual design trip point is 10%. The actual design trip time is 2.64 seconds. b) If Phase reversal protection is enabled and current is not sensed on one or more current xformer inputs. Logic will detect and trip in a maximum of 0.3 seconds from compressor start.	Local
Phase Reversal - xy	Cprsr	Immediate	Latch	Compressor energized to transition command [All Other Times]	A phase reversal was detected on the incoming current. On a compressor startup, the phase reversal logic must detect and trip in a maximum of 0.3 second from compressor start.	Local
Power Loss - xy	Cprsr	Immediate	NonLatch	All compressor running modes [all compressor starting and non-running modes]	The compressor had previously established currents while running and then all three phases of current were lost. Design: Less than 10% RLA, trip in 2.64 seconds. This diagnostic will preclude the Phase Loss Diagnostic and the Transition Complete Input Opened Diagnostic from being called out. To prevent this diagnostic from occurring with the intended disconnect of main power, the minimum time to trip must be greater than the guaranteed reset time of the Starter module. Note: This diagnostic prevents nuisance latching diagnostics due to a momentary power loss – It does not protect motor/compressor from uncontrolled power reapplication. See Momentary Power Loss Diagnostic for this protection. This diagnostic is not active during the start mode before the transition complete input is proven. Thus a random power loss during a start would result in either a “Starter Fault Type 3” or a “Starter Did Not Transition” latching diagnostic.	Remote
Severe Current Imbalance xy	Circuit	Immediate	Latch	All Running Modes	A 30% Current Imbalance has been detected on one phase relative to the average of all 3 phases for 90 continuous seconds.	Local
Starter Comm Loss: Main Processor - xy	Cprsr	Immediate	Latch	All	The Starter module detected a continual loss of communication with the main processor for greater than the Communications Loss Time bound setpoint.	Local
Starter Contactor Interrupt Failure – xy	Chiller	Info and Special Action	Latch	Starter Contactor Energized [Starter Contactor Energized]	Detected compressor currents greater than 10% RLA on any or all phases when the compressor was commanded off. Detection time shall be 5 second minimum and 10 seconds maximum. On detection and until the controller is manually reset: generate diagnostic, energize the appropriate alarm relay, continue to energize the Evap Pump Output, continue to command the affected compressor off, fully unload the effected compressor and command a normal stop to all other compressors. For as long as current continues, perform liquid level, oil return, and fan control on the circuit effected.	Local
Starter Did Not Transition - xy	Cprsr	Immediate	Latch	On the first check after transition.	The Starter Module did not receive a transition complete signal in the designated time from its command to transition. The Must Hold time from the Starter Module transition command is 1 second. The Must Trip time from the transition command is 6 seconds. Actual design is 2.5 seconds. This diagnostic is active only for Y-Delta, Auto-Transformer, Primary Reactor, and X-Line Starters.	Local

Diagnostics

Table 45. Starter diagnostics (continued)

Diagnostic Name and Source	Affects Target	Severity	Persistence	Active Modes [Inactive Modes]	Criteria	Reset Level
Starter Dry Run Test - xy	Circuit	Immediate	Latch	Starter Dry Run Mode	While in the Starter Dry Run Mode either 50% Line Voltage was sensed at the Potential Transformers or 10% RLA Current was sensed at the Current Transformers.	Local
Starter Failed to Arm/Start - xy	Cprsr	Immediate	Latch	All	Starter failed to arm or start within the allotted time (15 seconds).	Local
Starter Fault Type I - xy	Cprsr	Immediate	Latch	Starting - Y Delta Starters Only	This is a specific starter test where 1M(1K1) is closed first and a check is made to ensure that there are no currents detected by the CT's. If currents are detected when only 1M is closed first at start, then one of the other contactors is shorted.	Local
Starter Fault Type II - xy	Cprsr	Immediate	Latch	Starting - All types of starters	a. This is a specific starter test where the Shorting Contactor (1K3) is individually energized and a check is made to ensure that there are no currents detected by the CT's. If current is detected when only S is energized at Start, then 1M is shorted. b. This test in a. above applies to all forms of starters (Note: It is understood that many starters do not connect to the Shorting Contactor.)	Local
Starter Fault Type III - xy	Cprsr	Immediate	Latch	Starting [Adaptive Frequency Starter Type]	As part of the normal start sequence to apply power to the compressor, the Shorting Contactor (1K3) and then the Main Contactor (1K1) were energized. 1.6 seconds later there were no currents detected by the CT's for the last 1.2 Seconds on all three phases. The test above applies to all forms of starters except Adaptive Frequency Drives.	Local
Starter Module Memory Error Type 1 - xy (Starter Mem Err Type 1 - xy)	Cprsr	Info	Latch	All	Checksum on RAM copy of the Starter LLID configuration failed. Configuration recalled from EEPROM.	Local
Starter Module Memory Error Type 2 - xy (Starter Mem Err Type 2 - xy)	Cprsr	Immediate	Latch	All	Checksum on EEPROM copy of the Starter LLID configuration failed. Default configuration loaded into RAM and EEPROM.	Local
Transition Complete Input Opened - xy (Trnsn Compl Input Open xy)	Cprsr	Immediate	Latch	All running modes	The Transition Complete input was found to be opened with the compressor motor running after a successful completion of transition. This is active only for Y-Delta, Auto-Transformer, Primary Reactor, and X-Line Starters. To prevent this diagnostic from occurring as the result of a power loss to the contactors, the minimum time to trip must be greater than the trip time for the power loss diagnostic.	Local
Transition Complete Input Shorted - xy (Trnsn Compl Input Short xy)	Cprsr	Immediate	Latch	Pre-Start	The Transition Complete input was found to be shorted before the compressor was started. This is active for all electromechanical starters.	Local
Under Voltage	Chiller	Normal	NonLatch	Pre-Start and Any Ckt(s) Energzd	Nom. trip: 60 seconds at less than 87.5%, ? 2.8% at 200V ? 1.8% at 575V, Auto Reset at 90% or greater for 10 cont secs.	Remote

Main Processor Diagnostics

Table 46. Main processor diagnostics

Diagnostic Name	Affects Target	Severity	Persistence	Active Modes [Inactive Modes]	Criteria	Reset Level
AFD%RLA Feedback - xA	Cprsr	Normal	Latch	All	Out-Of-Range Low or Hi or bad LLID	Remote
BAS Communication Lost	Chiller	Info and Special Action	NonLatch	All	The BAS was setup as "installed" at the MP and the Lontalk LCIC lost communications with the BAS for 15 contiguous minutes after it had been established. Refer to Section on Setpoint Arbitration to determine how setpoints and operating modes may be affected by the comm loss. The chiller follows the value of the Tracer Default Run Command which can be previously written by Tracer and stored nonvolatily by the MP (either use local or shutdown). Note that this diagnostic is never operational for BacNet Communication interface (BCIC) and only operational with a LonTalk Communication interface (LCIC) if so configured by the BAS or Tracer system.	Remote
BAS Failed to Establish Communication <u>BAS Failed to Establish Comm</u>	Chiller	Info and Special Action	NonLatch	At power-up	The BAS was setup as "installed" and the BAS did not communicate with the Lontalk LCIC within 15 minutes after chiller controls power-up. Refer to Section on Setpoint Arbitration to determine how setpoints and operating modes may be affected. Note that this diagnostic is never operational for BacNet Communication interface (BCIC) and only operational with a LonTalk Communication interface (LCIC) if so configured by the BAS or Tracer system.	Remote
Chiller Service Recommended	Chiller	Warning	Latch	Service Messages Enabled	Chiller service interval time has elapsed. Chiller service is recommended.	Remote
Compressor Discharge Refrigerant Temperature Sensor - xy <u>Cprsr Disch Rfgt Temp Sensor - xy</u> <u>Disch Rfgt Temp Sensor - xy</u>	Cprsr	Immediate	Latch	All	Bad Sensor or LLID	Remote
Condenser Refrigerant Pressure Sensor <u>Condenser Rfgt Pressure Sensor</u> <u>Cond Rfgt Pressure Sensor</u>	Circuit	Immediate	Latch	All	Bad Sensor or LLID	Remote
Emergency Stop Feedback Input <u>Emergency Stop</u>	Chiller	Immediate	Latch	All	EMERGENCY STOP FEEBBACK INPUT is open. An external interlock has tripped. Time to trip from input opening to unit stop shall be 0.1 to 1.0 seconds.	Local
Evap Water Pump 1 Svc Recommended Evap Water Pump 1 Svc Recom	Chiller	Info	Latch	Service Messages Enabled	Pump service recommended as service interval hours have elapsed.	Remote



Diagnostics

Table 46. Main processor diagnostics (continued)

Diagnostic Name	Affects Target	Severity	Persistence	Active Modes [Inactive Modes]	Criteria	Reset Level
Evap Water Pump 2 Svc Recommended Evap Water Pump 2 Svc Recom	Chiller	Info	Latch	Service Messages Enabled	Pump service recommended as service interval hours have elapsed.	Remote
Evaporator Approach Error	Circuit	Immediate	Latch	Respective circuit running	The Evaporator approach temperature for the respective circuit (ELWT – Evap Sat Temp Ckt x) is negative by more than 10°F for 1 minute continuously while the circuit / compressor is operating. Either the Evap Leaving Water Temp sensor or Evap Suction Rfgrt Pressure Sensor Ckt x is in error.	Remote
Evaporator Entering Water Pressure <u>Evap Entering Water Pressure</u>	Chiller	Warning	Latch	All	Bad Sensor or LLID	Remote
Evaporator Entering Water Temperature Sensor <u>Evaporator Entering Water Temp Sensor</u> <u>Evap Ent Water Temp Sensor</u>	Chiller	Normal	Latch	All	Bad Sensor or LLID. Note: Entering Water Temp Sensor is used in EXV pressure control as well as ice making so it must cause a unit shutdown even if ice or CHW reset is not installed.	Remote
Evaporator Isolation Valve Closed Switch Failure <u>Evap Isolation Valve Closed Switch Failure</u> <u>Evap Iso Vlv Closed Sw Fail</u>	Circuit	Immediate	Latch	All	Evaporator isolation valve open limit switch state does not match expected value. See Evaporator Isolation Valve spec for details.	Local
Evaporator Isolation Valve Failed To Close <u>Evap Isolation Valve Failed To Close</u> <u>Evap Iso Vlv Failed To Close</u>	Circuit	Immediate	Latch	All	Evaporator isolation valve was commanded to close, but limit switches did not make expected changes within allotted time. See Evaporator Isolation Valve spec for details.	Local

Table 46. Main processor diagnostics (continued)

Diagnostic Name	Affects Target	Severity	Persistence	Active Modes [Inactive Modes]	Criteria	Reset Level
Evaporator Isolation Valve Failed To Open <i>Evap Isolation Valve Failed To Open</i> <u>Evap Iso Vlv Failed To Open</u>	Circuit	Immediate	Latch	All	Evaporator isolation valve was commanded to open, but limit switches did not make expected changes within allotted time. See Evaporator Isolation Valve spec for details.	Local
Evaporator Isolation Valve Illegal Switch State <i>Evap Isolation Valve Illegal Switch State</i> <u>Evap Iso Vlv Illegal Sw Stat</u>	Circuit	Immediate	Latch	All	Both evaporator isolation valve limit switches were closed at the same time, which should not be possible. Check for limit switch failure or improperly adjusted switch points.	Local
Evaporator Isolation Valve Open Switch Failure <i>Evap Isolation Valve Open Switch Failure</i> <u>Evap Iso Vlv Open Sw Fail</u>	Circuit	Immediate	Latch	All	Evaporator isolation valve closed limit switch state does not match expected value. See Evaporator Isolation Valve spec for details.	Local
Evaporator Leaving Water Pressure <u>Evap Leaving Water Pressure</u>	Chiller	Info	Latch	All	Bad Sensor or LLID	Remote
Evaporator Leaving Water Temperature Sensor <i>Evaporator Leaving Water Temp Sensor</i> <u>Evap Leav Water Temp Sensor</u>	Chiller	Normal	Latch	All	Bad Sensor or LLID	Remote
Evaporator Pump 1 Fault	Chiller	Immediate or Warning and Special Action	NonLatch	All	For systems with no evaporator pump, a single evaporator pump, or a single inverter driving dual evaporator pumps, an immediate shutdown shall be performed. For multiple pump systems, detection of a pump fault will generally cause pump control to switch to the redundant pump. For single inverter, dual pump configuration, switching to the redundant pump can only happen after the fault is cleared. Specific details of special action are described in Evaporator_Water_Pump_Control.doc	Remote

Diagnostics

Table 46. Main processor diagnostics (continued)

Diagnostic Name	Affects Target	Severity	Persistence	Active Modes [Inactive Modes]	Criteria	Reset Level
Evaporator Pump 2 Fault	Chiller	Immediate or Warning and Special Action	NonLatch	All	For systems with no evaporator pump, a single evaporator pump, or a single inverter driving dual evaporator pumps, an immediate shutdown shall be performed. For multiple pump systems, detection of a pump fault will generally cause pump control to switch to the redundant pump. For single inverter, dual pump configuration, switching to the redundant pump can only happen after the fault is cleared. Specific details of special action are described in Evaporator_Water_Pump_Control.doc	Remote
Evaporator Refrigerant Pool Temperature Sensor Error <i>Evap Rfgt Pool Temp Sensor Error</i> <u>Evap Pool Temp Error</u>	Circuit	Warning and Special Action	Latch	Ckt Energized [Ckt Not Energized]	The evaporator refrigerant pool temperature measurement is larger than the evaporator entering water temperature by more than 4°C (7.2°F) for 5 continuous minutes. There is an ignore time of 2 minutes following circuit startup. The trip criteria is not evaluated (and time above the threshold is not counted) until the ignore time passes. Invalidate evaporator pool temperature sensor measurement if this diagnostic is active. If evaporator isolation valves are installed, revert to Evaporator Shell Refrigerant Saturated Temperature for freeze protection functions. If evaporator isolation valves are not installed, revert to Evaporator Saturated Temperature for freeze protection functions. Pool Temp Sensor may have failed due to incorrect installation, improper insulation, or an offset pool temperature measurement typically caused by moisture intrusion.	Local
Evaporator Refrigerant Pool Temperature Sensor <i>Evap Rfgt Pool Temp Sensor</i> <u>Evap Rfgt Pool Temp Sensor</u>	Circuit	Warning and Special Action	Latch	All	Bad Sensor or LLID. Note: The Evap Pool Temp Sensors are used for evaporator freeze protection (running and non-running). Invalidate evaporator pool temperature sensor measurement if this diagnostic is active. If evaporator isolation valves are installed, revert to Evaporator Shell Refrigerant Saturated Temperature for freeze protection functions. If evaporator isolation valves are not installed, revert to Evaporator Saturated Temperature for freeze protection functions.	Remote
Evaporator Shell Refrigerant Pressure Sensor <i>Evaporator Shell Rfgt Pressure Sensor</i> <u>Evap Shell Rfgt Press Sensor</u>	Circuit	Normal	Latch	All	Bad Sensor or LLID. Note: The evaporator shell refrigerant pressure sensor is used to avoid high shell pressures, to equalize evaporator and condenser pressure prior to circuit start, and as a backup sensor to the pool temperature sensor.	Remote
Evaporator Water Flow Lost – Pump 1 <u>Evap Water Flow Lost Pump 1</u>	Chiller	Warning and Special Action	NonLatch	All	For dual evaporator pump configurations only. Evaporator Water Flow Lost diagnostic occurred while Pump 1 was the selected pump. Specific details of special action are described in Evaporator_Water_Pump_Control.doc	Remote
Evaporator Water Flow Lost – Pump 2 <u>Evap Water Flow Lost Pump 2</u>	Chiller	Warning and Special Action	NonLatch	All	For dual evaporator pump configurations only. Evaporator Water Flow Lost diagnostic occurred while Pump 2 was the selected pump. Specific details of special action are described in Evaporator_Water_Pump_Control.doc	Remote
Evaporator Water Flow Lost <u>Evap Water Flow Lost</u>	Chiller	Immediate	NonLatch	[All Stop modes]	A. The Evaporator water flow switch input was open for more than 6 contiguous seconds (or 20 seconds for thermal dispersion type flow switch). B. This diagnostic does not de-energize the evap pump output. C. 6 seconds of contiguous flow shall clear this diagnostic.	Remote

Table 46. Main processor diagnostics (continued)

Diagnostic Name	Affects Target	Severity	Persistence	Active Modes [Inactive Modes]	Criteria	Reset Level
Evaporator Water Flow Overdue – Pump 1 <u>Evap_Wtr_Flow_Overdue_Pump_1</u>	Chiller	Warning and Special Action	NonLatch	All	After the pump request was activated, the evaporator water flow overdue wait time elapsed before water flow was established. Special action is to keep the evap pump request active in a diagnostic override mode. See Evaporator_Water_Pump_Control.doc	Remote
Evaporator Water Flow Overdue – Pump 2 <u>Evap_Wtr_Flow_Overdue_Pump_2</u>	Chiller	Warning and Special Action	NonLatch	All	After the pump request was activated, the evaporator water flow overdue wait time elapsed before water flow was established. Special action is to keep the evap pump request active in a diagnostic override mode. See Evaporator_Water_Pump_Control.doc	Remote
Evaporator Water Flow Overdue <u>Evap_Water_Flow_Overdue</u>	Chiller	Normal	NonLatch	Estab. Evap. Water Flow on going from STOP to AUTO or Evap Pump Override.	Evaporator water flow was not proven within 20 minutes of the Evaporator water pump relay being energized in normal “Stop” to “Auto” transition. If the pump is overridden to “On” for certain diagnostics, the delay on diagnostic callout shall be only 255 seconds. The pump command status will not be effected by this diagnostic in either case.	Remote
Excessive Condenser Pressure	Circuit	Immediate	Latch	All	The condenser pressure sensor of this circuit has detected a condensing pressure in excess of the design high side pressure as limited by the particular compressor type.	Remote
External Chilled Water Setpoint <u>Ext_Chilled_Wtr_Setpt</u>	Chiller	Info	Latch	All	a. Function Not “Enabled”: no diagnostics. b. “Enabled “: Out-Of-Range Low or Hi or bad LLID, set diagnostic, default CWS to next level of priority (e.g. Front Panel SetPoint).	Remote
External Demand Limit Setpoint <u>Ext_Demand_Limit_Setpoint</u>	Chiller	Info	Latch	All	a. Not “Enabled”: no diagnostics. b. “Enabled “: Out-Of-Range Low or Hi or bad LLID, set diagnostic, default CLS to next level of priority (e.g. Front Panel SetPoint.)	Remote
EXV Pressure Equalization Failed <u>EXV_Press_Equalization_Fail</u>	Circuit	Immediate	Latch	All	EXV Pressure Equalization process failed to meet the equalization criteria within the allotted time.	Remote
Free Cooling Entering Water Temperature <u>FC_Entering_Water_Temp</u>	Free Cooling	Normal	Latch	All	Bad Sensor or LLID	Remote
Heat Recovery Entering Water Temperature Sensor <u>Heat_Recovery_Entering_Water_Temp_Sensor</u>	Chiller	Info	Latch	All	Bad Sensor or LLID	Remote

Diagnosics

Table 46. Main processor diagnostics (continued)

Diagnostic Name	Affects Target	Severity	Persistence	Active Modes [Inactive Modes]	Criteria	Reset Level
Heat Recovery Leaving Water Temperature Sensor <i>Heat Recovery Leaving Water Temp Sensor</i> <u>Heat Rcvry Leav Water Temp</u>	Chiller	Info	Latch	All	Bad Sensor or LLID	Remote
High Compressor Refrigerant Discharge Temp - xy <i>High Cprsr Rfgt Discharge Temp - xy</i> <u>High Cprsr Disch Temp XY</u>	Cprsr	Immediate	Latch	All [compressor run unload or compressor not running]	The compressor discharge temperature exceeded 199.4°F (without oil cooler) or 230°F (with oil cooler). This diagnostic will be suppressed during Stopping mode or after the compressor has stopped. Note: As part of the Compressor High Temperature Limit Mode (aka Minimum Capacity Limit), the compressor shall be forced loaded as the filtered discharge temperature reaches 190°F (without oil coolers), or 220°F (with oil coolers).	Remote
High Differential Refrigerant Pressure - xy <i>High Differential Rfgt Pressure - xy</i> <u>High Diff Rfgt Pressure - xy</u>	Cprsr	Normal	Latch	Cprsr Energized	GP2 Cprsr: The differential pressure for the respective circuit was above 275 Psid (1890 kPa) for 2 consecutive samples 5 seconds apart.	Remote
High Evaporator Refrigerant Pressure <i>High Evap Rfgt Pressure</i> <u>High Evap Rfgt Pressure</u>	Chiller	Immediate	NonLatch	All	The evaporator refrigerant pressure of either circuit has risen above 190 psig. The evaporator water pump relay will be de-energized to stop the pump regardless of why the pump is running. The diagnostic will auto reset and the pump will return to normal control when all of the evaporator pressures fall below 185 psig. The primary purpose is to stop the evaporator water pump and its associated pump heat from causing refrigerant side pressures, close to the evaporator relief valve setting, when the chiller is not running, such as could occur with Evap Water Flow Overdue or Evaporator Water Flow Loss Diagnostics.	Remote
High Evaporator Shell Refrigerant Pressure – Circuit 1 <i>High Evap Shell Rfgt Pressure - Ckt1</i> <u>High Evap Shell Press Ckt1</u>	Chiller	Immediate	NonLatch	All	The evaporator shell refrigerant pressure is installed, is valid, and has risen above 190 psig. <ul style="list-style-type: none"> - De-energize evaporator water pump regardless of why the pump is running. - Open the circuit's EXV to 20% to allow refrigerant flow to other parts of the chiller, if liquid line refrigerant pressure is less than 170 psig. Return EXV to normal control (allow it to close until needed for circuit operation) if liquid line refrigerant pressure is greater than 175 psig. Automatically clear diagnostic when evaporator shell refrigerant pressure is valid and drops below 180 psig. - Allow evaporator water pump to return to normal control. - Return circuit's EXV to normal control (allow it to close until needed for circuit operation). Primary causes of this diagnostic: <ul style="list-style-type: none"> - Evaporator water pump heat transferred to evaporator, either by flow blockage, or by lack of heat dissipation in the water loop in the presence of flow. - Commissioning unit in high ambient temperature environments. - Water box heater thermostat failed closed. 	Remote

Table 46. Main processor diagnostics (continued)

Diagnostic Name	Affects Target	Severity	Persistence	Active Modes [Inactive Modes]	Criteria	Reset Level
High Evaporator Shell Refrigerant Pressure – Circuit 2 <u>High Evap Shell Rfgt Pressure - Ckt2</u> <u>High Evap Shell Press Ckt2</u>	Chiller	Immediate	NonLatch	All	See Circuit 1 description.	Remote
High Evaporator Water Temperature <u>High Evap Water Temperature</u>	Chiller	Info and Special Action	NonLatch	Only effective if either 1)Evap Wtr Flow Overdue 2)Evap Wtr Flow Loss or 3)Low Evap Rfgt Temp, - Unit Off, diagnostic is active.	Either the leaving or the entering water temperature exceeded the high evap water temp limit (TU service menu settable –default 105F(65.55C), range 80F(26.67C)-150F(65.55C) for 15 continuous seconds. The evaporator water pump relay will be de-energized to stop the pump but only if it is running due one of the diagnostics listed on the left. The diagnostic will auto reset and the pump will return to normal control when both the entering and leaving temperatures fall 5°F below the trip setting. The primary purpose is to stop the evaporator water pump and its associated pump heat from causing excessive waterside temperatures and waterside pressures when the chiller is not running but the evap pump is on due to either Evap Water Flow Overdue, Evaporator Water Flow Loss, or Low Evap Temp – Unit Off Diagnostics. This diagnostic will not auto clear solely due to the clearing of the enabling diagnostic.	Remote
High Motor Winding Temperature – xA <u>High Mtr Wndng Temp - xA</u>	Circuit	Immediate	Latch	All	The respective compressor’s motor winding thermostat is detected to be open. The compressor shall stop within 5 seconds of this diagnostic.	Local
High Oil Temperature - xy	Cprsr	Immediate	Latch	All [compressor run unload or compressor not running]	The oil temperature entering the compressor exceeded 199.4°F.	Remote
High Pressure Cutout - xy	Cprsr	Immediate	Latch	All	A high pressure cutout was detected; trip at 315 ± 5 PSIG. For AFD compressor configurations, the HPC is connected directly to the AFD and the UC800 will get an AFD Fault – xA diagnostic when the HPC is tripped.	Local
High Refrigerant Pressure Ratio - xy <u>High Rfgt Press Ratio - xy</u>	Cprsr	Immediate	Latch	Cprsr Energized	The pressure ratio for the respective circuit exceeded 12.3 for 1 contiguous minute while any compressor is running or in service pumpdown. This pressure ratio is a fundamental limitation of the HiVi compressor. The pressure ratio is defined as Pcond (abs)/ Pevap(abs).	Remote
Inverted Evaporator Water Temperature <u>Inverted Evap Water Temp</u>	Chiller	Warning	NonLatch	Any Ckt Energized [No Ckts Energized]	The entering evaporator water temp fell below the leaving evaporator water temp by more than 2°F for 180 °F-sec, minimum trip time 30 seconds. It can warn of improper flow direction through the evaporator, misbound water temperature sensors, improper sensor installation, partially failed sensors, or other system problems. Note that either entering or leaving water temp sensor or the water system could be at fault.	Remote
LCI-C Software Mismatch: Use BAS Tool <u>LCI-C Software Mismatch</u>	Chiller	Info	Nonlatch	All	The neuron software in the LCI-C module does not match the chiller type. Download the proper software into the LCI-C neuron. To do this, use the Rover service tool, or a LonTalk® tool capable of downloading software to a Neuron 3150®.	Remote

Diagnostics

Table 46. Main processor diagnostics (continued)

Diagnostic Name	Affects Target	Severity	Persistence	Active Modes [Inactive Modes]	Criteria	Reset Level
Liquid Line Pressure Sensor	Circuit	Normal	Latch	All	Bad Sensor or LLID. Note: This is the subcooled liquid line pressure sensor.	Remote
Liquid Line Temperature Sensor <i>Liquid Line Temp Sensor</i> <u>Liquid Line Temp Sensor</u>	Circuit	Normal	Latch	All	Bad Sensor or LLID. Note: This is the subcooled liquid line temp sensor.	Remote
Loss of Oil for Compressor (Running) <u>Loss of Oil for Cprsr (Run)</u>	Circuit	Immediate	Latch	Starter Contactor Energized	In running modes, Oil Loss Level Sensor detects lack of oil in the oil sump feeding the compressor (distinguishing a liquid flow from a vapor flow).	Local
Loss of Oil for Compressor (Stopped) <u>Loss of Oil for Cprsr (Stop)</u>	Circuit	Immediate and Special Action	Latch	Compressor Pre-start [all other modes]	Oil Loss Level Sensor detects a lack of oil in the oil sump feeding the compressor for 90 seconds after EXV preposition is completed (and before EXV equalization, if applicable) on an attempted circuit start. Note: Compressor start is delayed pending oil detection during that time, but not allowed once the diagnostic occurs.	Local
Low Differential Refrigerant Pressure - xy <i>Low Differential RfgtPressure - xy</i> <u>Low Diff Rfgt Press - xy</u>	Cprsr	Immediate	Latch	Cprsr Energized	The system differential pressure for the respective circuit was below the greater of 25 psid (240.5 kPa) or the pressure ratio listed in the table in GP2 Compressor Type FSpec while the compressor is running for a period of time dependent on the deficit (15 sec ignore time from circuit start) – refer to the Oil Flow Protection specification for the time to trip function.	Remote
Low Discharge Superheat - xy	Cprsr	Normal	Latch	Any Running Mode	While Running Normally, the Discharge Superheat was less than the Low Discharge Superheat Setpoint for more than 6500 degree F seconds. At circuit startup, the Discharge Superheat will be ignored for 5 minutes.	Remote
Low Evaporator Rfgt Temp Circuit 1: Unit Off <i>Low Evaporator Rfgt Temp Ckt 1: Unit Off</i> <u>Low Evap Rfgt Temp: Unit Off</u>	Chiller	Special Action	NonLatch	Unit in Stop Mode, or in Auto Mode and No Ckt's Energzd [Any Ckt Energzd]	The respective circuit's LERTC Integral was seen to be > 0 while the chiller is in the Stop mode, or in Auto mode with no compressors running for at least one minute. The LERTC integral is increased if the Evap Refrigerant Pool Temp is below the value of the Low Evap Rfgt Temp Cutout + 2°F. Energize Evap Water Pump and Off-Cycle Freeze Avoidance Request Relay until diagnostic auto resets, then return to normal evap pump control and de-energize the Freeze Avoidance Request. Automatic reset occurs when the respective Evap Rfgt Pool Temp rises 4°F (1.1°C) above the LERTC cutout setting for 1 minute and the Chiller Off LERTC Integral = 0. This diagnostic even while active, does not prevent operation of either circuit.	Remote
Low Evaporator Rfgt Temp Circuit 2: Unit Off <i>Low Evaporator Rfgt Temp Ckt 2: Unit Off</i> <u>Low Evap Rfgt Temp: Unit Off</u>	Chiller	Special Action	NonLatch	Unit in Stop Mode, or in Auto Mode and No Ckt's Energzd [Any Ckt Energzd]	The respective circuit's LERTC Integral was seen to be > 0 while the chiller is in the Stop mode, or in Auto mode with no compressors running for at least one minute. The LERTC integral is increased if the Evap Refrigerant Pool Temp is below the value of the Low Evap Rfgt Temp Cutout + 2°F. Energize Evap Water Pump and Off-Cycle Freeze Avoidance Request Relay until diagnostic auto resets, then return to normal evap pump control and de-energize the Freeze Avoidance Request. Automatic reset occurs when the respective Evap Rfgt Pool Temp rises 4°F (1.1°C) above the LERTC cutout setting for 1 minute and the Chiller Off LERTC Integral = 0. This diagnostic even while active, does not prevent operation of either circuit.	Remote

Table 46. Main processor diagnostics (continued)

Diagnostic Name	Affects Target	Severity	Persistence	Active Modes [Inactive Modes]	Criteria	Reset Level
Low Evaporator Water Temp (Unit Off) <u>Low Evap. Water Temp-Unit Off</u>	Chiller	Special Action	NonLatch	Unit in Stop Mode, or in Auto Mode and No Ckt(s) Energzd [Any Ckt Energzd]	Either the entering or leaving evaporator water temp. fell below the leaving water temp cutout setting for 30 degree F seconds while the Chiller is in the Stop mode, or in Auto mode with no compressors running. Energize Freeze Avoidance Request Relay and Evap Water Pump Relay until diagnostic auto resets, then de-energize the Freeze Avoidance Request Relay and return to normal evap pump control. Automatic reset occurs when both temps rise 2°F (1.1°C) above the cutout setting for 5 minutes, or either circuit starts. This diagnostic even while active, does not prevent operation of either circuit.	Remote
Low Evaporator Water Temp (Unit On) <u>Low Evap. Water Temp-Unit On</u>	Chiller	Immediate and Special Action	NonLatch	Any Ckt[s] Energzd [No Ckt(s) Energzd]	The evaporator entering or leaving water temperature fell below cutout setpoint for 30 degree F Seconds while the compressor was running. Automatic reset occurs when both of the temperature rises 2°F (1.1°C) above the cutout setting for 2 minutes. This diagnostic shall not de-energize the Evaporator Water Pump Output.	Remote
Low Oil Flow - xy	Cprsr	Immediate	Latch	Cprsr Energized and Delta P above 15 Psid	The intermediate oil pressure sensor for this compressor was out of the acceptable pressure range for 15 seconds, while the Delta Pressure was greater than 15 Psid (172.4 kPa).: Acceptable range is 0.50 > (PC-PI) / (PC-PE) for the first 2.5 minutes of operation, and 0.28 > (PC-PI) / (PC-PE) thereafter.	Local
Low Refrigerant Temperature	Circuit	Immediate	Latch	All Ckt Running Modes	The respective Evaporator Refrigerant Pool Temperature dropped below the Low Refrigerant Temperature Cutout Setpoint for 2250°F-sec (12°F-sec max rate for early circuit startup period) while the circuit was running. The minimum LRTC setpoint is -5°F (18.7 Psia) the point at which oil separates from the refrigerant. The integral is held nonvolatile though power down, is continuously calculated, and can decay or build during the circuit off cycle as conditions warrant.	Remote
Low Suction Refrigerant Pressure <u>Low Suction Rfgt Pressure</u> <u>Low Suction Rfgt Pressure</u>	Circuit	Immediate	Latch	Cprsr Prestart and Cprsr Energized	a. The Suction Pressure dropped below 10 Psia just prior to compressor start (after EXV preposition). b. During Early Startup Period: the Suction Pressure fell below a pressure equal to Condenser Pressure ÷ 8 but as limited to not less than 6 or greater than 10 psia. c. After Early Startup Period expires: The Suction Pressure fell below 16 Psia. (Note: the Early Startup Period is between 1 and 5 min as an inverse function of the Cond Temp measured at time of circuit startup).	Local
Mfr Maintenance Recommended - xy <u>Maint. Recommended xy</u>	Cprsr	Info	Latch	Service Messages Enabled	Compressor service recommended as service interval hours have elapsed.	Remote
MP: Invalid Configuration	Platform	Immediate	Latch	All	MP has an invalid configuration based on the current software installed.	Remote
MP: Reset Has Occurred	None	Info	Latch	All	The main processor has successfully come out of a reset and built its application. A reset may have been due to a power up, installing new software or configuration. This diagnostic is immediately and automatically cleared and thus can only be seen in the Historic Diagnostic List in Tracer TU.	Remote
No Differential Refrigerant Pressure - xy <u>No Differential Rfgt Pressure - xy</u> <u>No Diff Rfgt Press - xy</u>	Cprsr	Immediate	Latch	Compressor running on Circuit	The system differential pressure was below 7.7 Psid (53 kPa) for 6 seconds after the 11 seconds ignore time relative to cprsr/circuit startup had expired. In a two compressor circuit, the lower of the two suction pressures is used for DP.	Remote

Diagnostics

Table 46. Main processor diagnostics (continued)

Diagnostic Name	Affects Target	Severity	Persistence	Active Modes [Inactive Modes]	Criteria	Reset Level
Oil Flow Protection Fault xy	Cprsr	Immediate	Latch	Starter Contactor Energized [all Stop modes]	The Intermediate Oil Pressure Sensor for this cprsr is reading a pressure either above its respective circuit's Condenser Pressure by 15 Psia or more, or below its respective Suction Pressure 10 Psia or more for 30 seconds continuously.	Local
Oil Pressure Sensor - xy	Cprsr	Immediate	Latch	All	Bad Sensor or LLID	Remote
Oil Temperature Sensor - xy <u>Oil Temp Sensor - xy</u>	Cprsr	Normal	Latch	All	Bad Sensor or LLID	Remote
Outdoor Air Temperature Sensor <u>Outdoor Air Temp Sensor</u>	Chiller	Normal	Latch	All	Bad Sensor or LLID.	Remote
Pumpdown Terminated By Time	Circuit	Info	Latch	Service Pumpdown	Service Pumpdown cycle for this circuit was terminated abnormally due to excessive time (RTAF max Service Pumpdown = 4 min.).	Local
Restart Inhibit Invoked - xy <u>Restart Inhibit xy</u>	Cprsr	Info	Latch	All	When restart inhibit warning is enabled, the warning exists when unit has been inhibited from starting and is cleared when a start of a compressor is possible (Start-to-Start Timer expires)	Remote
Software Error 1001: Call Trane Service <u>SW Error 1001-Call Trane</u>	All functions	Immediate	Latch	All	A high level software watchdog has detected a condition in which there was a continuous 1 minute period of compressor operation, with neither Evaporator water flow nor a" contactor interrupt failure" diagnostic active. The presence of this software error message suggests an internal software problem has been detected. The events that led up to this failure, if known, should be recorded and transmitted to Trane Controls Engineering.	Local
Software Error 1002: Call Trane Service <u>SW Error 1002-Call Trane</u>	All functions	Immediate	Latch	All	Reported if state chart misalignment in stopped or inactive state occurred while a compressor was seen to be operating and this condition lasted for at least 1 minute (cprsr operation due to Service Pumpdown or with Contactor Interrupt Failure diagnostic is excluded). The presence of this software error message suggests an internal software problem has been detected. The events that led up to this failure, if known, should be recorded and transmitted to Trane Controls Engineering.	Local
Software Error 1003: Call Trane Service <u>SW Error 1003-Call Trane</u>	All functions	Immediate	Latch	All	Reported if state chart misalignment occurred inferred from the Capacity Control, Circuit, or Compressor State Machines remaining in the Stopping state for more than 3 minutes. The presence of this software error message suggests an internal software problem has been detected. The events that led up to this failure, if known, should be recorded and transmitted to Trane Controls Engineering.	Local
Starts/Hours Modified <u>Starts/Hours Modified</u>	Cprsr	Info	NonLatch	All	The current value for the cumulative starts and or hours for the given compressor have been modified by a write override from TU.	Remote
Suction Refrigerant Pressure Sensor - xy <u>Suction Pressure Sensor - xy</u>	Cprsr	Immediate	Latch	All	Bad Sensor or LLID	Remote

Table 46. Main processor diagnostics (continued)

Diagnostic Name	Affects Target	Severity	Persistence	Active Modes [Inactive Modes]	Criteria	Reset Level
Unexpected Starter Shutdown - xy <u>Unexpected Starter Shtdn - xy</u>	Cprsr	Normal	NonLatch	All Cprsr Running modes, Starting, Running and Preparing to Shutdown	The Starter module status reported back that it is stopped when the MP thinks it should be running and no Starter diagnostic exist. This diagnostic will be logged in the active buffer and then automatically cleared. This diagnostic could be caused by intermittent communication problems from the Starter to the MP, or due to mis-binding	Local
Very Low Evaporator Rfgr Pressure - xy <u>Very Low Evap Rfgr Pressure - xy</u> <u>Very Low Evap Rfgr Press xy</u>	Chiller	Immediate	Latch	All	The respective circuit's evaporator pressure dropped below 80% of the current Low Evap Refrig Press Cutout setting (see above) or 8 psia, whichever is less, regardless of the running state of the circuit's compressor. Note: Unlike previous products, even if the circuit associated with the suction pressure sensor is locked out, it will not defeat the protection afforded by this diagnostic.	Local
Water System Differential Pressure <u>Water System Diff Pressure</u>	Chiller	Info	Latch	All	Bad Sensor or LLID	Remote

Communication Diagnostics

Notes:

- The following communication loss diagnostics will not occur unless that input or output is required to be present by the particular configuration and installed options for the chiller.
- Communication diagnostics (with the exception of "Excessive Loss of Comm" are named by the Functional Name of the input or output that is no longer being heard from by the Main Processor. Many LLIDs, such as the Quad Relay LLID, have more than one functional output associated with it. A comm loss with such a multiple function board, will generate multiple diagnostics. Refer to the Chiller's wiring diagrams to relate the occurrence of multiple communication diagnostics back to the physical LLID boards that they have been assigned to (bound).
- Communication loss diagnostics shall be timed based on action (target status) and not annunciation on the operator display.

Table 47. Communications diagnostics

Diagnostic Name	Affects Target	Severity	Persistence	Active Modes [Inactive Modes]	Criteria	Reset Level
Comm Loss: %RLA Indication Output (Vdc) <u>Comm: RLA Output</u>	None	Info	Latch	All	Continual loss of communication between the MP and the Functional ID has occurred for a 15-30 second period.	Remote
Comm Loss: Liquid Line Pressure <u>Comm: Liquid Line Pressure</u>	Circuit	Normal	Latch	All	Continual loss of communication between the MP and the Functional ID has occurred for a 30 second period.	Remote
Comm Loss: Oil Temperature - xy <u>Comm: Oil Temp - xy</u>	Cprsr	Normal	Latch	All	Continual loss of communication between the MP and the Functional ID has occurred for a 30 second period.	Remote
Comm Loss: AFD Fault Input xA <u>Comm: AFD Fault xA</u>	Cprsr	Normal	Latch	All	Continual loss of communication between the MP and the Functional ID has occurred for a 30 second period.	Remote
Comm Loss: AFD Run Command - xA <u>Comm: AFD Run Command - xA</u>	Cprsr	Normal	Latch	All	Continual loss of communication between the MP and the Functional ID has occurred for a 30 second period.	Remote
Comm Loss: AFD Speed Command - xA <u>Comm: Speed Command - xA</u>	Cprsr	Normal	Latch	All	Continual loss of communication between the MP and the Functional ID has occurred for a 15-30 second period.	Remote
Comm Loss: Auxiliary Setpoint Command <u>Comm: Auxiliary Setpt Cmd</u>	Chiller	Info	Latch	All	Continual loss of communication between the MP and the Functional ID has occurred for a 15-30 second period.	Remote
Comm Loss: Chiller Bypass Valve Output <u>Comm: Chiller Bypass Valve</u>	Chiller	Normal	Latch	All	Continual loss of communication between the MP and the Functional ID has occurred for a 30 second period.	Remote
Comm Loss: Compressor Discharge Rfght Temperature - xy <i>Comm Loss: Cprsr Disch Rfght Temp - xy</i> <u>Comm: Cprsr Disch Temp xy</u>	Cprsr	Normal	Latch	All	Continual loss of communication between the MP and the Functional ID has occurred for a 30 second period.	Remote
Comm Loss: Condenser Fan Enable <u>Comm: Cond Fan Enable</u>	Circuit	Normal	Latch	All	Continual loss of communication between the MP and the Functional ID has occurred for a 30 second period.	Remote
Comm Loss: Condenser Fan Enable, Shared Circuit 1&2 <i>Comm Loss: Cond Fan Enbl Shared Ckt1&2</i> <u>Comm: Cond Fan Enbl Ckt 1&2</u>	Circuit	Info	Latch	All	Continual loss of communication between the MP and the Functional ID has occurred for a 30 second period. This is an info warning, as it is conceivable that the circuit may run without the center shared fan deck working if there are many other coils/fans on the circuits.	Remote

Table 47. Communications diagnostics (continued)

Diagnostic Name	Affects Target	Severity	Persistence	Active Modes [Inactive Modes]	Criteria	Reset Level
Comm Loss: Condenser Refrigerant Pressure <i>Comm Loss: Condenser Rfgt Pressure</i> <u>Comm: Cond Rfgt Pressure</u>	Circuit	Immediate	Latch	All	Continual loss of communication between the MP and the Functional ID has occurred for a 30 second period.	Remote
Comm Loss: Condenser Refrigerant Tank Valve <i>Comm Loss: Cond Rfgt Tank Valve</i> <u>Comm: Cond Rfgt Tank Vlv</u>	Circuit	Normal	Latch	All	Continual loss of communication between the MP and the Functional ID has occurred for a 30 second period.	Remote
Comm Loss: Electronic Expansion Valve <u>Comm: EXV</u>	Circuit	Normal	Latch	All	Continual loss of communication between the MP and the EXV Step Status has occurred for a 30 second period, OR EXV Steps Maximum Position has not been received. If EXV Steps Maximum Position has not been received, MP will periodically request EXV Steps Maximum Position, since it is only transmitted upon request.	Remote
Comm Loss: Emergency Stop Feedback Input <u>Comm: Emergency Stop</u>	Chiller	Normal	Latch	All	Continual loss of communication between the MP and the Functional ID has occurred for a 30 second period.	Remote
Comm Loss: Energy Meter Pulse Input <u>Comm: Energy Pulse Input</u>	None	Info	Latch	All	Continual loss of communication between the MP and the Functional ID has occurred for a 30 second period.	Remote
Comm Loss: Evaporator Entering Water Pressure <i>Comm Loss: Evap Entering Water Pressure</i> <u>Comm: Evap Ent Water Press</u>	Chiller	Info	Latch	All	Continual loss of communication between the MP and the Functional ID has occurred for a 30 second period.	Remote
Comm Loss: Evaporator Entering Water Temperature <i>Comm Loss: Evap Entering Water Temp</i> <u>Comm: Evap Ent Water Temp</u>	Chiller	Normal	Latch	All	Continual loss of communication between the MP and the Functional ID has occurred for a 30 second period. Note: Entering Water Temp Sensor is used in EXV pressure control as well as ice making & CHW reset, so it must cause a unit shutdown even if Ice or CHW reset is not installed.	Remote
Comm Loss: Evaporator Isolation Valve Close Switch <i>Comm Loss: Evap Iso Valve Close Switch</i> <u>Comm: Evap Iso Vlv Close Sw</u>	Circuit	Immediate	Latch	All	Continual loss of communication between the MP and the Functional ID has occurred for a 30 second period.	Remote
Comm Loss: Evaporator Isolation Valve Open Switch <i>Comm Loss: Evap Iso Valve Open Switch</i> <u>Comm: Evap Iso Vlv Open Sw</u>	Circuit	Immediate	Latch	All	Continual loss of communication between the MP and the Functional ID has occurred for a 30 second period.	Remote
Comm Loss: Evaporator Isolation Valve Relay <i>Comm Loss: Evap Isolation Valve Relay</i> <u>Comm: Evap Iso Valve Relay</u>	Circuit	Immediate	Latch	All	Continual loss of communication between the MP and the Functional ID has occurred for a 30 second period.	Remote
Comm Loss: Evaporator Leaving Water Pressure <i>Comm Loss: Evap Leaving Water Pressure</i> <u>Comm: Evap Leav Water Press</u>	Chiller	Info	Latch	All	Continual loss of communication between the MP and the Functional ID has occurred for a 30 second period.	Remote



Diagnostics

Table 47. Communications diagnostics (continued)

Diagnostic Name	Affects Target	Severity	Persistence	Active Modes [Inactive Modes]	Criteria	Reset Level
Comm Loss: Evaporator Leaving Water Temperature <i>Comm Loss: Evap Leaving Water Temp</i> <u>Comm: Evap Leav Water Temp</u>	Chiller	Normal	Latch	All	Continual loss of communication between the MP and the Functional ID has occurred for a 30 second period.	Remote
Comm Loss: Evaporator Pump 1 Fault Input <u>Comm: Evap Pump Fault Input</u>	Chiller	Normal	Latch	All	Continual loss of communication between the MP and the Functional ID has occurred for a 30 second period.	Remote
Comm Loss: Evaporator Pump 2 Fault Input <u>Comm: Evap Pump Fault Input</u>	Chiller	Normal	Latch	All	Continual loss of communication between the MP and the Functional ID has occurred for a 30 second period.	Remote
Comm Loss: Evaporator Pump Inverter 1 Run Command <i>Comm Loss: Evap Pump Inv 1 Run Command</i> <u>Comm: Evap Water Pump Relay</u>	Chiller	Normal	Latch	All	Continual loss of communication between the MP and the Functional ID has occurred for a 30 second period.	Remote
Comm Loss: Evaporator Refrigerant Pool Temperature <i>Comm Loss: Evap Rfgt Pool Temp</i> <u>Comm: Evap Rfgt Pool Temp</u>	Circuit and Chiller	Special Action and Info	Latch	All	Continual loss of communication between the MP and the Functional ID has occurred for a 30 second period. Invalidate evaporator pool temperature sensor measurement if this diagnostic is active. If evaporator isolation valves are installed, revert to Evaporator Shell Refrigerant Saturated Temperature for freeze protection functions. If evaporator isolation valves are not installed, revert to Evaporator Saturated Temperature for freeze protection functions.	Remote
Comm Loss: Evaporator Shell Refrigerant Pressure <i>Comm Loss: Evap Shell Rfgt Pressure</i> <u>Comm: Evap Shell Rfgt Press</u>	Circuit	Normal	Latch	All	Continual loss of communication between the MP and the Functional ID has occurred for a 30 second period.	Remote
Comm Loss: Evaporator Water Flow Switch <u>Comm: Evap Water Flow Sw</u>	Chiller	Immediate	Latch	All	Continual loss of communication between the MP and the Functional ID has occurred for a 30 second period.	Remote
Comm Loss: Evaporator Water Pump 1 Relay <u>Comm: Evap Wtr Pump Relay x</u>	Chiller	Normal	Latch	All	Continual loss of communication between the MP and the Functional ID has occurred for a 30 second period.	Remote
Comm Loss: Evaporator Water Pump 2 Relay <u>Comm: Evap Water Pump Relay</u>	Chiller	Normal	Latch	All	Continual loss of communication between the MP and the Functional ID has occurred for a 30 second period.	Remote
Comm Loss: Evaporator Water Pump Inverter 1 Fault Input <i>Comm Loss: Evap Pump Inv 1 Fault Input</i> <u>Comm: Evap Pump Fault Input</u>	Chiller	Normal	Latch	All	Continual loss of communication between the MP and the Functional ID has occurred for a 30 second period.	Remote
Comm Loss: Evaporator Water Pump Inverter Frequency Input <i>Comm Loss: Evap Water Pump Inv Freq Input</i> <u>Comm: Evap Watr Pmp Inv Freq</u>	Chiller	Normal	Latch	All	Continual loss of communication between the MP and the Functional ID has occurred for a 30 second period.	Remote

Table 47. Communications diagnostics (continued)

Diagnostic Name	Affects Target	Severity	Persistence	Active Modes [Inactive Modes]	Criteria	Reset Level
Comm Loss: Evaporator Water Pump Inverter Speed <i>Comm Loss: Evap Water Pump Inverter Speed</i> <u>Comm: Evap Water Pump Speed</u>	Chiller	Normal	Latch	All	Continual loss of communication between the MP and the Functional ID has occurred for a 30 second period.	Remote
Comm Loss: Ext Noise Reduction Request <u>Comm: Ext Noise Reduct Input</u>	None	Info	Latch	All	Continual loss of communication between the MP and the Functional ID has occurred for a 30 second period.	Remote
Comm Loss: External Auto/Stop <u>Comm: External Auto/ Stop</u>	Chiller	Normal	Latch	All	Continual loss of communication between the MP and the Functional ID has occurred for a 30 second period.	Remote
Comm Loss: External Chilled Water Setpoint <i>Comm Loss: Ext Chilled Water Setpoint</i> <u>Comm: Ext Chilled Wtr Setpt</u>	External Chilled Water Setpoint	Special Action	Latch	All	Continual loss of communication between the MP and the Functional ID has occurred for a 30 second period. Chiller shall discontinue use of the External Chilled Water Setpoint source and revert to the next higher priority for setpoint arbitration	Remote
Comm Loss: External Ckt Lockout <i>Comm Loss: External Ckt Lockout</i> <u>Comm: Ext Ckt Lockout</u>	Circuit	Special Action	Latch	All	Continual loss of communication between the MP and the Functional ID has occurred for a 30 second period. MP will nonvolatile hold the lockout state (enabled or disabled) that was in effect at the time of comm loss.	Remote
Comm Loss: External Demand Limit Setpoint <i>Comm Loss: Ext Demand Limit Setpoint</i> <u>Comm: Ext Demand Lim Setpt</u>	External Demand Limit setpoint	Special Action	Latch	All	Continual loss of communication between the MP and the Functional ID has occurred for a 30 second period. Chiller shall discontinue use of the External Demand limit setpoint and revert to the next higher priority for Demand Limit setpoint arbitration.	Remote
Comm Loss: External Ice Building Command <u>Comm: Ext Ice Building Cmd</u>	Ice Making Mode	Special Action	Latch	All	Continual loss of communication between the MP and the Functional ID has occurred for a 30 second period. Chiller shall revert to normal (non-ice building) mode regardless of last state.	Remote
Comm Loss: Fan Board 1 Relay X <u>Comm: Fan Board 1 Relay X</u>	Circuit	Normal	Latch	All	Continual loss of communication between the MP and the Functional ID has occurred for a 30 second period.	Remote
Comm Loss: Fan Board 2 Relay X <u>Comm: Fan Board 2 Relay X</u>	Circuit	Normal	Latch	All	Continual loss of communication between the MP and the Functional ID has occurred for a 30 second period.	Remote
Comm Loss: Fan Inverter Speed Command <u>Comm: Fan Inverter Speed Cmd</u>	Circuit	Normal	Latch	All	Continual loss of communication between the MP and the Functional ID has occurred for a 15-30 second period.	Remote
Comm Loss: Fan Inverter Speed Command, Shared Circuit 1 & 2 <i>Comm Loss: Fan Inv Spd Cmd, Shrd Ckt 1&2</i> <u>Comm: Fan Inv Spd Cmd Ckt 1&2</u>	Circuit	Info	Latch	All	Continual loss of communication between the MP and the Functional ID has occurred for a 15-30 second period. This is an info warning, as it is conceivable that the circuit may run without the center shared fan deck working if there are many other coils/fans on the circuits.	Remote
Comm Loss: Free Cooling Entering Water Temperature <i>Comm Loss: FC Entering Water Temp</i> <u>Comm: FC Ent Water Temp</u>	Free Cooling	Normal	Latch	All	Continual loss of communication between the MP and the Functional ID has occurred for a 30 second period.	Remote
Comm Loss: Free Cooling Valve <u>Comm: Free Cooling Valve</u>	Free Cooling	Normal	Latch	All	Continual loss of communication between the MP and the Functional ID has occurred for a 30 second period.	Remote

Diagnostics

Table 47. Communications diagnostics (continued)

Diagnostic Name	Affects Target	Severity	Persistence	Active Modes [Inactive Modes]	Criteria	Reset Level
Comm Loss: Free Cooling Bypass Valve <i>Comm: Free Cooling Bypass Valve</i>	Free Cooling	Normal	Latch	All	Continual loss of communication between the MP and the Functional ID has occurred for a 30 second period.	Remote
Comm Loss: Free Cooling Pump <i>Comm: Free Cooling Pump</i>	Free Cooling	Normal	Latch	All	Continual loss of communication between the MP and the Functional ID has occurred for a 30 second period.	Remote
Comm Loss: Heat Recovery Entering Water Temperature Sensor <i>Comm Loss: HR Entering Water Temp Sensor</i> <i>Comm: HR Entering Water Temp</i>	Chiller	Info	Latch	All	Continual loss of communication between the MP and the Functional ID has occurred for a 30 second period.	Remote
Comm Loss: Heat Recovery Leaving Water Temperature Sensor <i>Comm Loss: HR Leaving Water Temp Sensor</i> <i>Comm: HR Leaving Water Temp</i>	Chiller	Info	Latch	All	Continual loss of communication between the MP and the Functional ID has occurred for a 30 second period.	Remote
Comm Loss: High Pressure Cutout Switch - xy <i>Comm Loss: High Pressure Cutout Sw - xy</i> <i>Comm: High Pres Cutout Sw - xy</i>	Cprsr	Normal	Latch	All	Continual loss of communication between the MP and the Functional ID has occurred for a 30 second period.	Remote
Comm Loss: Liquid Line Temperature <i>Comm: Liquid Line Temp</i>	Circuit	Normal	Latch	All	Continual loss of communication between the MP and the Functional ID has occurred for a 30 second period. Note: The Subcooled Liquid Line Temperature Sensors are used for determination of charge and accurate tonnage predictions	Remote
Comm Loss: Local BAS Interface <i>Comm: Local BAS Interface</i>	Chiller	Info	NonLatch	All	Continual loss of communication between the MP and the Functional ID has occurred for a 30 second period. Use last valid BAS setpoints. Diagnostic is cleared when successful communication is established with the LonTalk LLID (LCIC) or BacNet LLID (BCIC).	Remote
Comm Loss: Motor RLA Input - xA <i>Comm: Motor RLA Input - xA</i>	Cprsr	Normal	Latch	All	Continual loss of communication between the MP and the Functional ID has occurred for a 30 second period.	Remote
Comm Loss: Motor Winding Thermostat Compressor 1A <i>Comm Loss: Motor Winding Tstat Cprsr 1A</i> <i>Comm: Motor Tstat Cprsr 1A</i>	Circuit	Normal	Latch	All	Continual loss of communication between the MP and the Functional ID has occurred for a 30 second period.	Remote
Comm Loss: Motor Winding Thermostat Compressor 2A <i>Comm Loss: Motor Winding Tstat Cprsr 2A</i> <i>Comm: Motor Tstat Cprsr 2A</i>	Circuit	Normal	Latch	All	Continual loss of communication between the MP and the Functional ID has occurred for a 30 second period.	Remote
Comm Loss: Oil Loss Level Sensor Input <i>Comm Loss: Oil Loss Level Sensor Input</i> <i>Comm: Oil Level Sensor</i>	Circuit	Normal	Latch	All	Continual loss of communication between the MP and the Functional ID has occurred for a 30 second period.	Remote
Comm Loss: Oil Pressure - xy <i>Comm: Oil Pressure - xy</i>	Cprsr	Immediate	Latch	All	Continual loss of communication between the MP and the Functional ID has occurred for a 30 second period.	Remote

Table 47. Communications diagnostics (continued)

Diagnostic Name	Affects Target	Severity	Persistence	Active Modes [Inactive Modes]	Criteria	Reset Level
Comm Loss: Oil Return Line Solenoid Valve -xy <i>Comm Loss: Oil Return Solenoid Valve - xy</i> <u>Comm: Oil Ret Sol Vlv xy</u>	Cprsr	Normal	Latch	All	Continual loss of communication between the MP and the Functional ID has occurred for a 30 second period.	Remote
Comm Loss: Outdoor Air Temperature <u>Comm: Outdoor Air Temp</u>	Chiller	Normal	Latch	All	Continual loss of communication between the MP and the Functional ID has occurred for a 30 second period.	Remote
Comm Loss: Programmable Relay Board 1 <u>Comm: Program Relay Board 1</u>	None	Info	Latch	All	Continual loss of communication between the MP and the Functional ID has occurred for a 30 second period.	Remote
Comm Loss: Programmable Relay Board 2 <u>Comm: Program Relay Board 2</u>	None	Info	Latch	All	Continual loss of communication between the MP and the Functional ID has occurred for a 30 second period.	Remote
Comm Loss: Slide Valve Load - xy <u>Comm: Slide Valve Load - xy</u>	Cprsr	Normal	Latch	All	Continual loss of communication between the MP and the Functional ID has occurred for a 30 second period.	Remote
Comm Loss: Slide Valve Unload - xy <u>Comm: Slide Valve Unload - xy</u>	Cprsr	Normal	Latch	All	Continual loss of communication between the MP and the Functional ID has occurred for a 30 second period.	Remote
Comm Loss: Starter xy	Cprsr	Immediate	Latch	All	Continual loss of communication between the MP and the Functional ID has occurred for a 30 second period.	Local
Comm Loss: Step Load - xy <u>Comm: Step Load - xy</u>	Cprsr	Normal	Latch	All	Continual loss of communication between the MP and the Functional ID has occurred for a 30 second period.	Remote
Comm Loss: Suction Refrigerant Pressure - xy <i>Comm Loss: Suction Rfgt Pressure - xy</i> <u>Comm: Suction Rfgt Press xy</u>	Cprsr	Immediate	Latch	All [Ckt/ Cprsr lock out]	Continual loss of communication between the MP and the Functional ID has occurred for a 30 second period.	Remote
Comm Loss: Water System Differential Pressure <i>Comm Loss: Water System Diff Pressure</i> <u>Comm: Water Sys Diff Press</u>	Chiller	Info	Latch	All	Continual loss of communication between the MP and the Functional ID has occurred for a 30 second period.	Remote



Wiring

The table below provides a list of electrical schematics, field wiring diagrams and connection diagrams for RTAF units. Complete wiring package is documented in RTAF-SVE001*-EN. A laminated wiring diagram booklet is also shipped with each chiller.

Table 48. RTAF unit wiring drawing numbers

Drawing Number	Description
RTAF Unit sizes 115 to 270 ton	
5722-6999	Schematic Diagram — 115 to 270 ton units
5722-7552	Panel Component Location Diagram — 115 to 270 ton units
5722-7580	Unit Component Location — 115 to 270 ton units
2311-3537	Field Wiring Diagram — 115 to 270 ton units
5722-7578	Field Wiring Layout — 115 to 270 ton units
RTAF Unit sizes 280 to 520 tons	
5722-7670	Schematic Diagram — 280 to 520 tons
5722-7904	Panel Component Location Diagram — 280 to 520 ton units
5722-7905	Unit Component Location — 280 to 520 ton units
5722-7906	Field Wiring Diagram — 280 to 520 ton units
5722-7907	Field Wiring Layout — 280 to 520 ton units



Log and Check Sheets

The operator log and check sheet are included for use as appropriate, for installation completion verification before Trane start-up is scheduled, and for reference during the Trane start-up.

Where the log or check sheet also exists outside of this publication as standalone literature, the literature order number is also listed.

- Sintesis™ Model RTAF Installation Completion Check Sheet and Request for Trane Service (RTAF-ADF001*-EN)
- Operator Log



Log and Check Sheets

Page left intentionally blank



Sintesis™ RTAF

Installation Completion Check Sheet and Request for Trane Service

Important: A copy of this completed form must be submitted to the Trane service agency that will be responsible for the start-up of the chiller. Start-up will NOT proceed unless applicable items listed in this form have been satisfactorily completed. **See unit IOM RTAF-SVX001*-EN for detailed installation instructions.**

To:	Trane Service Office:
S.O. Number:	Serial Numbers:
Job/Project Name:	
Address:	
The following items are being installed and will be completed by:	

Important: Start-up must be performed by Trane or an agent of Trane specifically authorized to perform start-up of Trane® products. Contractor shall provide Trane (or an agent of Trane specifically authorized to perform start-up) with notice of the scheduled start-up at least two weeks prior to the scheduled start-up.

Important: It is required that heaters are energized for a minimum of 24 hours prior to start up. Therefore, chiller should have power for this amount of time before Trane Service arrives to do start-up.

Copyright

This document and the information in it are the property of Trane, and may not be used or reproduced in whole or in part without written permission. Trane reserves the right to revise this publication at any time, and to make changes to its content without obligation to notify any person of such revision or change.

Trademarks

All trademarks referenced in this document are the trademarks of their respective owners.

Revision History

- Added drain/vent requirement in Piping.
- Added NEC reference to Wiring

Check boxes if the task is complete or if the answer is "yes."

1. Chiller

- Installation meets foundation requirements.
- In place and piped.
- Isolation pads or elastomeric pads installed (optional).

2. Refrigerant Pressure Check

- PRIOR to water being added to the system, use gauges to verify positive pressure in the evaporator and condenser. Lack of pressure could indicate a system leak. When charging in the factory, approximately 95% of the refrigerant charge is isolated in the evaporator, and the other 5% is contained in the condenser and compressor. In the event that no pressure is present, contact local Trane service.

Note: Verification must be done by gauges. Do NOT rely only on values from unit transducers.

3. Piping

- Water piping flushed before making final connections to the system
- Chilled water piping connected to:
 - Evaporator
 - Air handling units
 - Pumps
- Flow switch or flow proving device installed
- Strainer installed in entering evaporator water piping and cleaned
- Drain and vents in both evaporator waterboxes are piped with shutoff valve, or plugs have been reinstalled.
- Water supply connected to filling system
- Does unit have freeze inhibitor? If unit has freeze inhibitor:
 - Verify type and concentration correct per unit submittal

- Calculate and record freeze point of the solution: _____
- Systems filled
- Pumps run, air bled from system
- Relief valve ventilation piping installed (if applicable)
- Flow balancing valves installed in leaving chilled water
- Gauges, thermometers and air vents installed on both sides of evaporator

4. Wiring

- Wire size per submittal and NEC 310-16
- Full power available, and within utilization range
- External interlocks (flow switch, pumps auxiliary, etc.)
- Chilled water pump (connected and tested)
- 115 Vac power available for service tools (recommended)
- All controls installed and connected

5. Testing

- Dry nitrogen available for pressure testing
- Trace gas amounts of R-134a or R-513A available for leak testing (if required)

6. Refrigerant on job site (if nitrogen charge option, model number digit 16 = 3 or 4, is chosen)

7. Systems can be operated under load conditions

8. Heaters

- If unit was factory charged (model number digit 16 = 1 or 2), **energize heaters for 24 hours prior to start up.**
Important: It is required that chiller heaters are energized for a minimum of 24 hours prior to start up.
Therefore, chiller should have power for this amount of time before Trane Service arrives to do start-up.
- If unit has nitrogen charge (model number digit 16 = 3 or 4), contact Trane Service for unit charging prior to start-up.

9. Owner awareness

- Does the owner have a copy of the MSDS for refrigerant?

Note: Additional time required to properly complete the start-up and commissioning, due to any incompleteness of the installation, will be invoiced at prevailing rates.

This is to certify that the Trane® equipment has been properly and completely installed, and that the applicable items listed above have been satisfactorily completed.

Checklist completed by: _____

Signed: _____ Date: _____

In accordance with your quotation and our purchase order number _____, we will therefore require the presence of Trane service on this site, for the purpose of start-up and commissioning, by _____ (date).

Note: Minimum two-week advance notification is required to allow scheduling of the chiller start-up.

Additional comments/instructions: _____

Note: A copy of this completed form must be submitted to the Trane Service Office that will be responsible for start-up of chiller.

Trane - by Trane Technologies (NYSE: TT), a global climate innovator - creates comfortable, energy efficient indoor environments for commercial and residential applications. For more information, please visit trane.com or tranetechnologies.com.

Trane has a policy of continuous product and product data improvement and reserves the right to change design and specifications without notice. We are committed to using environmentally conscious print practices.



Operator Log

Sintesis™ RTAF Chiller with UC800 Controller - Tracer® AdaptiView™ Reports - Log Sheet												
	Unit				Circuit 1				Circuit 2			
	Start	15 min	30 min	1 hr	Start	15 min	30 min	1 hr	Start	15 min	30 min	1 hr
EVAPORATOR												
Active Chilled Water Setpoint												
Entering Water Temperature												
Leaving Water Temperature												
Saturated Refrigerant Temperature (°F)												
Refrigerant Pressure (psia)												
Approach Temperature (°F)												
Water Flow Status												
EXV % Open												
CONDENSER												
Outdoor Air Temperature												
Air Flow %												
Saturated Refrigerant Temperature (°F)												
Refrigerant Pressure (psia)												
Diff Refrigerant Pressure (psid)												
Discharge Refrigerant Sat Temp (°F)												
Discharge Refrigerant Temp (°F)												
Discharge Refrigerant Subcooling (°F)												
COMPRESSORS												
Compressor A												
Running Status												
Starts												
Running Time (Hr:Min)												
Oil Pressure (psia)												
Oil Temperature (°F)												
Motor A												
Active Demand Limit Setpoint												
Average Motor Current (%)												
Compressor B (if present)												
Running Status												
Starts												
Running Time (Hr:Min)												
Oil Pressure (psia)												
Oil Temperature (°F)												
Motor B (if present)												
Active Demand Limit Setpoint												
Average Motor Current (%)												

COMMENTS:

Date:

Technician:

Owner:

Trane - by Trane Technologies (NYSE: TT), a global climate innovator - creates comfortable, energy efficient indoor environments for commercial and residential applications. For more information, please visit trane.com or tranetechnologies.com.

Trane has a policy of continuous product and product data improvement and reserves the right to change design and specifications without notice. We are committed to using environmentally conscious print practices.