



Product Catalog

# Packaged Rooftop Air Conditioners

IntelliPak® with Symbio™ 800

Including eFlex™ /eDrive™

20 to 75 Ton





# Introduction

## Transform your rooftop experience

The next generation IntelliPak® with Symbio™ 800 goes beyond the rooftop to impact the entire customer lifecycle, maximizing outcomes with minimal energy. Advanced selection tools make designing your project a breeze while extensive product testing and lean manufacturing principles ensure quality at the source. Installation is fast and flexible with application specific and field programmable controls and advanced diagnostics deliver real-time building information to keep performance optimal.

From project inception to product replacement, Trane delivers a holistic solution through the IntelliPak rooftop unit completely engineered around the customer experience.

### Select

We make it easier to specify, select and engineer.

- Industry leading energy efficiency integrated with Trace™ 3D Plus modeling capability.
- Application specific and field programmable controller with expansion hardware.
- Reengineered selection tools with the customer in mind.

### Build

We have a culture of continuous improvement, committed to product quality.

- Extensive design validation and product testing.
- Lean 3P Tools (Production, Preparation, Process) tools in manufacturing operation.
- Enhanced training program for shop floor leadership and manufacturing associates.

### Install

We built a flexible system and simplified integration to minimize cost and time.

- Multiple communication protocol (BACnet® MSTP, BACnet® IP, Air-Fi™ Wireless, Modbus, LonTalk®).
- Unit specific points list included with submittal and shipped in unit.
- 7-inch user interface improves navigation, data viewing and ability to make operation changes.

### Perform

We deliver reliable operation and service through the entire life cycle.

- The Adaptive Control pre-empts potential equipment disruptions during rapidly changing conditions.
- Validate performance with factory installed power meter and Trane Intelligent Services.
- Improved diagnostics and connected capability enhances service monitoring.



## Copyright

This document and the information in it are the property of Trane, and may not be used or reproduced in whole or in part without written permission. Trane reserves the right to revise this publication at any time, and to make changes to its content without obligation to notify any person of such revision or change.

## Trademarks

All trademarks referenced in this document are the trademarks of their respective owners.

## Revision History

- Updated Digit 6 and 7 in Model Number.
- Added data and information for 1200 MBh natural gas and SCR modulating electric heat.
- Updated static pressure drop data.
- Running edits included in this version.



# Table of Contents

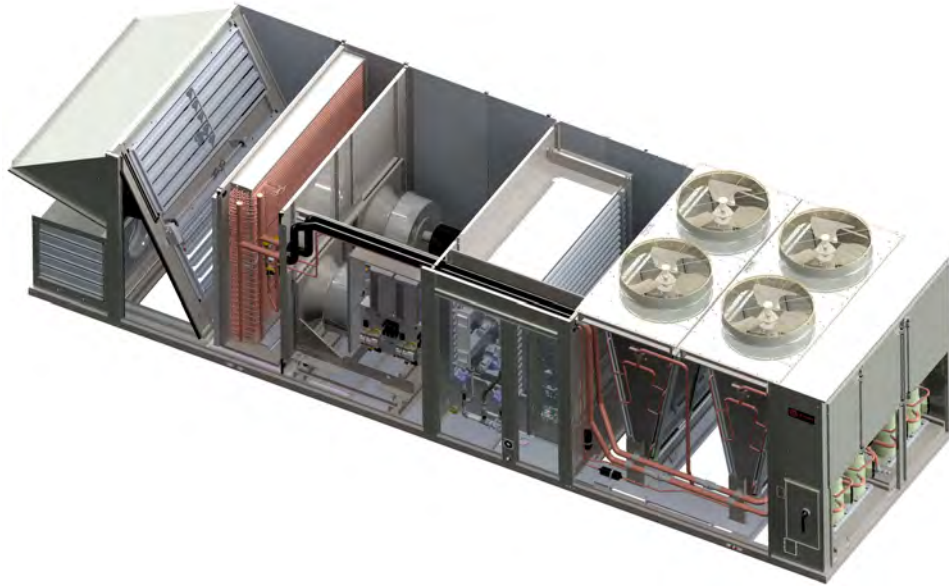
Features and Benefits.....	6
Cabinet .....	6
Refrigeration .....	7
Airflow.....	8
Electrical .....	10
Gas Heat .....	11
Electric Heat.....	12
Model Number Description .....	13
General Data.....	15
Symbio™ 800 Controls .....	21
Overview.....	21
Supply Air Pressure Control .....	22
Supply Air Temperature Controls .....	22
Zone Temperature Control.....	24
Single Zone Variable Air Volume (SZVAV) Only .....	25
Constant Volume (CV) Only.....	26
CV, SZVAV, and VAV .....	27
Specifications .....	33
Application Considerations .....	35
Clearance Requirements .....	35
Modulating Hot Gas Reheat for Dehumidification.....	35
Ventilation Control.....	35
Ventilation Override Sequences .....	36
Relief Fan Options .....	36
Acoustic Considerations.....	37
Corrosive Atmospheres .....	38
Natural Gas Heating Considerations.....	38
High Entering Return Temperatures .....	39
Performance Data .....	40
Performance Adjustment Factors.....	40
Gross Cooling Capacities .....	42
Heating Capacities .....	69
Fan Performance .....	70
Barometric Relief Damper Performance.....	82
Component Static Pressure Drops.....	82

Electrical Data .....	85
Electrical Service Sizing .....	85
Dimensional Data.....	91
Optional Configurations .....	99
Roof Curb .....	102
Electrical Entry Details.....	105
Access Clearances .....	106
Mechanical Specifications .....	108
General .....	108
Cabinet .....	108
Heating .....	108
Airflow.....	109
Relief Option .....	110
Refrigeration System.....	113
Electrical .....	115
Symbio™ 800 Controller .....	116
Accessories .....	116
Trane Startup.....	118
Certified AHRI Performance.....	121



# Features and Benefits

Figure 1. IntelliPak® with Symbio™ 800 Controller

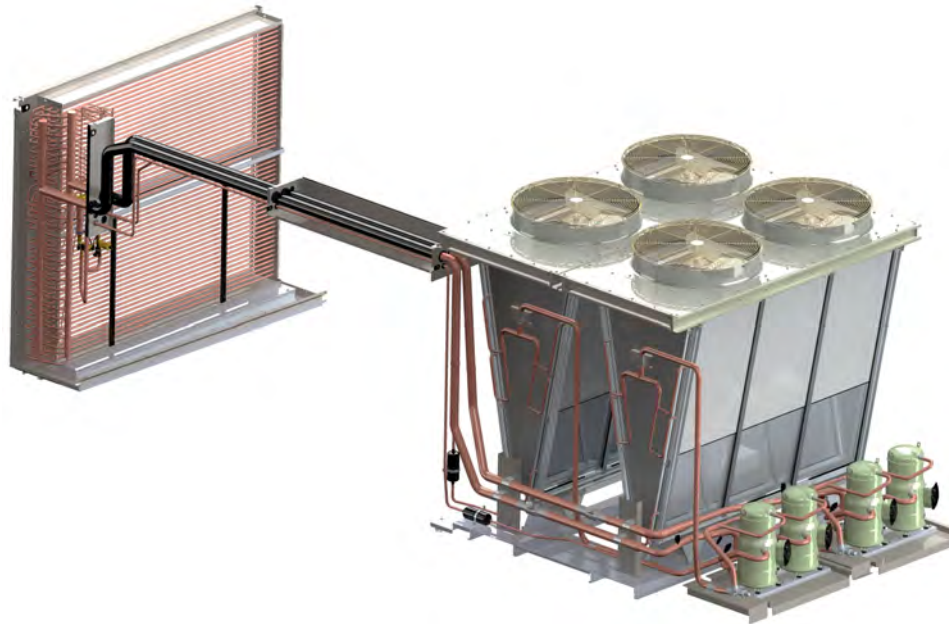


## Cabinet

Features	Benefits
Double-wall foam injected panels (doors, base and roof) with thermal resistance of R-9	Quality construction enables industry leading efficiency and reliability
Thermal break in all door, roof and base panels	Eliminates degradation of the exterior cabinet due to sweating
Air infiltration (leakage rate) of 0.5% at 1 inch wg. static pressure	Reduces wasteful heating and cooling loss through the cabinet airstream, and improves energy efficiency
Unit cabinet that can operate at a static pressure of + 6 in wg. on the fan outlet and -4 in wg. on the fan inlet	Supports a wider range of applications and internal components
Size optimized cabinet with up to a 30% reduction in unit length	Increases flexibility for new construction applications, reduced weight of unit
Pre-painted exterior galvanized steel panels durable enough to withstand a minimum of 672 consecutive hours of salt spray application in accordance with standard ASTM B117	Exterior paint holds up in corrosive environments
Pitched roof over air handler section	Prevents water leakage in cabinet, pooling water on top of cabinet, as well as paint wear
Single point fastening hinged access doors with a latching mechanism	Holds door open during service and prevents unsafe closure from wind
Factory rain and wind tested units	Ensures water and cabinet integrity
Units undergo ASTM D4169 level II factory shake tests and full shipping tests	Thoroughly tested structural integrity of cabinet helps ensure the unit arrives at the job site in top condition

# Refrigeration

Figure 2. Refrigeration piping



Features	Benefits
Industry leading energy efficiency for the Large Rooftop HVAC market	Energy savings for any application – all unit tonnages meet the Consortium for Energy Efficiency (CEE) Advanced tier for both EER & IEER and IECC path 2 for cooling
eFlex™ variable speed compressors available in all tonnages	Capacity control delivers industry leading energy efficiency, as well as more precise leaving air temperature control (+/- 1°F)
Electronic expansion valve	<ul style="list-style-type: none"> <li>• Enables more accurate superheat reading and control</li> <li>• Provides a more consistent superheat setting that improves energy efficiency and compressor reliability</li> <li>• Adds compressor protection and reliability</li> </ul>
Refrigeration pressure constantly monitored by a transducer	<ul style="list-style-type: none"> <li>• Monitors compressor operation in real time to ensure it is functioning within reliability limits</li> <li>• Improves reading of system state points for better unit control and protection, as compared to temperature sensors. Temperature sensors indirectly measure pressure and are slow to respond as the reading lags actual unit performance.</li> <li>• Allows the service technician to read system pressure on the user interface, rather than attaching gauges.</li> <li>• Provides loss of charge protection</li> </ul>

## Features and Benefits

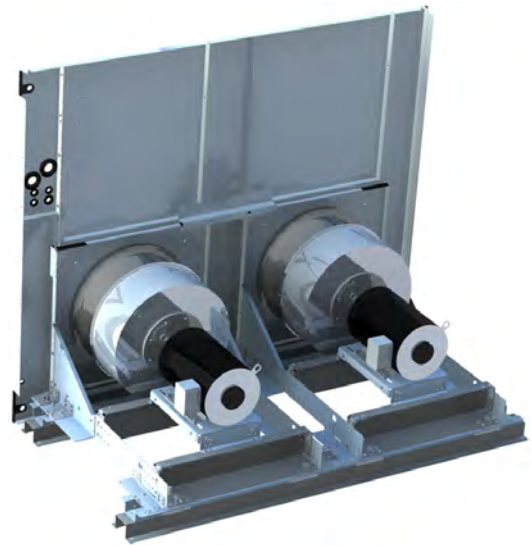
Features	Benefits
Variable speed condenser fan	<ul style="list-style-type: none"> <li>Enables unit to start down at temperatures to 0°F and operate down to -10°F to while improving head pressure control at any ambient condition</li> <li>Minimizes fan cycling and maximizes part load efficiency by closer control to minimum head pressure</li> </ul>
Corrosion protected condenser coil that will withstand ASTM B117 salt spray test for 6,000 hours and ASTM G85 A2 Cyclic Acidified Salt Fog test for 2,400 hours	Optimizes coil protection in more corrosive environments
Compressors located at the edge of the unit	Reduces service time if repairs are needed
Discharge and compressor isolation valves	
Double sloped evaporator coil drain pan (galvanized or stainless steel)	Prevents standing water, eliminating harmful bacterial growth

## Airflow

**Figure 3. View of relief fans**



**Figure 4. Supply fans**



Features	Benefits
Direct drive and variable speed fan solution (Supply and Relief)	<ul style="list-style-type: none"> <li>No belts or sheaves to maintain or to clog filters</li> <li>More efficient, higher static capability and improved acoustics relative to forward curve fans</li> <li>Ability to quickly adjust the speed and therefore airflow without having to purchase different belts or sheaves</li> </ul>
Tailored fan selection to meet unit application	Assortment of fan diameter and width options enable unit to meet customer's requirements - acoustics, performance, efficiency or cost



## Features and Benefits

Features	Benefits
Fan motor design speed set in the factory	Ease of installation. Beltless design eliminates the need to adjust sheaves on site
Single inlet supply fan with airfoil shaped blades	Independently verified fan performance
<ul style="list-style-type: none"> <li>• Two Supply fans per unit</li> <li>• Variable frequency drive for each supply fan</li> <li>• Electromechanical bypass for supply fan variable frequency drive</li> </ul>	System redundancy and improved serviceability from lighter components
Designed to meet CFM and static ranges of altitudes up to 8,000 feet	Able to support applications at higher elevations
Economizer meets ASHRAE 90.1-2016 requirements for leakage and economizer reliability	Reduces energy usage in both economizing and normal operating modes
Damper leakage rate down to 4 CFM/sq. ft. with fault detection and diagnostics	Energy efficiency and code compliance (ASHRAE 90.1, California Title 24)
Trane Air Quality (Traq™) Outside Air Measurement System	Measurement accuracy does not exceed 10% at minimum airflow and decreases to less than 5% at higher airflow, meeting requirements of LEED IE Q Credit 1 as defined by ASHRAE 62.1-2007
Statitrac™ direct space building pressurization control	Highly accurate and efficient method of maintaining building pressure control
Ventilation override mode	Flexibility to temporarily override airflow management during non-standard situations
Pre-Evaporator and Final Filter rating up to MERV 14 with filter status available at the user interface	Superior indoor air quality that meets ASHRAE 170 Healthcare facility requirement
Outside air intake validation and testing includes rain with 40 mph wind	Reliable outside air intake solution
42" from bottom of base rail to lowest point of the outside air intake	Adherence to codes and regulations

## Electrical

**Figure 5. Control panel**



Features	Benefits
Wired and tested at the factory	Run test report ships with every unit detailing tests completed in the factory
Intelligent control components and multiple control boxes in unit	Easier troubleshooting due to minimized wiring and localized connections
High and low voltage wiring is separated in the raceway	Reduces signal interference and potential for a false signal sent to the controls
Variable frequency drives communicate via Modbus	Real time information available as the drive is connected directly to the building automated system
Exterior USB connection for controller access	Ability to access controller without opening the control panel

## Gas Heat

**Figure 6. Gas heat configuration**



Features	Benefits
Tubular heat exchangers with induced draft burners tested under UL 795	Meets product safety regulations
81% steady state efficiency	All gas heaters meet the 2023 Department of Energy efficiency code
Flue to exhaust above the unit	Removes hot air away from the unit and prevents recirculation with the combustion intake
<ul style="list-style-type: none"> <li>• Staged, modulating and ultra modulating offer for each MBh</li> <li>• Low, medium and high heat offering</li> </ul>	Assortment of option combinations provides the best solution for a variety of applications, along with the ability to achieve turndown up to 20:1
Air rise capability up to 60°F	Range of capacity to meet discharge air temperature requirement

## Electric Heat

Figure 7. Electric heat configuration



Features	Benefits
Full faced element coil	Creates a more consistent heat profile
<ul style="list-style-type: none"> <li>• High grade element wire</li> <li>• Low watt density heater coils</li> </ul>	Allows for increased reliability
30 to 190 kW range	Provides best solution for the application
Air rise capability up to 50°F	Range of capacity meets discharge air temperature requirements
SCR (Modulating) Electric Heat Capability	Meets discharge air temperature requirements with greater precision



# Model Number Description

## Digit 1 — Unit Type

**R** = Packaged Rooftop

## Digit 2 — Unit Function

**A** = DX Cooling, No Heat  
**E** = DX Cooling, Electric Heat  
**F** = DX Cooling, Natural Gas Heat  
**X** = DX Cooling, No Heat, Extended Casing

## Digit 3, 4, 5 — Nominal Capacity

**020** = 20 Tons  
**025** = 25 Tons  
**030** = 30 Tons  
**040** = 40 Tons  
**050** = 50 Tons  
**055** = 55 Tons  
**060** = 60 Tons  
**070** = 70 Tons  
**075** = 75 Tons

## Digit 6— Heat Type & Capacity

**0** = None  
**1** = Natural Gas — 250 MBh  
**2** = Natural Gas — 350 MBh  
**3** = Natural Gas — 500 MBh  
**4** = Natural Gas — 850 MBh  
**5** = Natural Gas — 1200 MBh  
**7** = External Heat  
**A** = Electric — 30 kW  
**B** = Electric — 60 kW  
**C** = Electric — 90 kW  
**D** = Electric — 120 kW  
**E** = Electric — 150 kW  
**F** = Electric — 190 kW

## Digit 7 — Heat Performance

**0** = None  
**1** = Gas — Staged, Aluminized Steel  
**2** = Gas — Staged, Stainless Steel  
**3** = Gas — Modulating, Stainless Steel  
**4** = Gas — Ultra Modulating, Stainless Steel  
**A** = Electric — Staged  
**B** = Electric — SCR Modulating

## Digit 8 — Unit Voltage

**E** = 200/60/3  
**F** = 230/60/3  
**4** = 460/60/3  
**5** = 575/60/3 (WYE)

## Digit 9 — Refrigeration System Performance

**1** = Standard Efficiency & Capacity  
**2** = High Efficiency & Capacity  
**3** = eFlex™ – Variable Speed Compressor w/ High Capacity

## Digit 10, 11— Design Sequence

**AA** = Current Design Sequence

## Digit 12 — Development Sequence

**A** = Development Sequence

## Digit 13 — Airflow Direction

**A** = Downflow Supply & Upflow Return

## Digit 14 — System Control

**0** = Constant Volume (Zone Temperature)  
**1** = Constant Volume (Discharge Air Temperature)  
**2** = Single Zone VAV (Zone Temperature)  
**3** = Multi Zone VAV (Discharge Air Temperature)

## Digit 15 — Dual Supply Fan - Direct Drive

**A** = 16.5 inch, 80% width  
**B** = 16.5 inch, 100% width  
**D** = 18.2 inch, 100% width  
**E** = 20.0 inch, 80% width  
**F** = 20.0 inch, 100% width  
**G** = 22.2 inch, 80% width  
**H** = 22.2 inch, 100% width  
**J** = 24.5 inch, 80% width  
**K** = 24.5 inch, 100% width  
**M** = 27.0 inch, 100% width

## Digit 16 — Dual Supply Fan Motor Type

**1** = ODP w/ RPM greater than or equal to 1600  
**2** = ODP w/ RPM less than 1600

## Digit 17 — Dual Supply Fan Motor

**A** = 3 hp (1.5 hp per)  
**B** = 6 hp (3 hp per)  
**C** = 10 hp (5 hp per)  
**D** = 15 hp (7.5 hp per)  
**E** = 20 hp (10 hp per)  
**F** = 30 hp (15 hp per)  
**G** = 40 hp (20 hp per)  
**H** = 50 hp (25 hp per)

## Digit 18 — Relief Option

**0** = None  
**1** = Barometric Relief  
**2** = Relief Fan - Direct Drive & Variable Speed

## Digit 19 — Relief Fan Motor

**0** = None  
**2** = 6 hp  
**3** = 8 hp  
**4** = 12 hp  
**5** = 15 hp  
**6** = 16 hp  
**7** = 23 hp

## Digit 20 — Space Pressure Management

**0** = None  
**1** = Statitrac

## Digit 21 — Variable Frequency Drive (VFD) Bypass

**0** = None  
**A** = Supply

## Digit 22 — Future Use

**0** = None

## Digit 23 — Ventilation Override Mode

**0** = None  
**1** = Yes

## Digit 24 — Pre-Evaporator Coil Filter

**A** = 2" MERV 4 Panel  
**B** = 2" MERV 8 Panel  
**C** = 4" MERV 8 Panel  
**D** = 4" MERV 14 Panel  
**E** = 2" MERV 8 Panel & MERV 14 Cartridge  
**F** = Rack Only - 2" Panel  
**G** = Rack Only - 4" Panel  
**H** = Rack Only - 2" Panel & Cartridge

## Digit 25 — Final Filter

**0** = None  
**1** = 2" MERV 8 Panel & MERV 14 Cartridge  
**2** = Rack Only - 2" Panel & Cartridge

## Digit 26 — Filter Monitoring

**0** = None  
**A** = Pre-Evaporator Filter  
**C** = Pre-Evaporator & Final Filter



## Model Number Description

---

### Digit 27 — Outside Air

- 0 = None
- 1 = 0-25% Manual Damper
- 2 = 0-100% Economizer
- 3 = 0-100% Economizer w/Demand Ctrl Ventilation (DCV)
- 4 = 0-100% Economizer w/Traq & DCV

### Digit 28 — Outside Air Control

- 0 = None
- A = Economizer w/Dry Bulb
- B = Economizer w/Reference Enthalpy
- C = Economizer w/Comparative Enthalpy

### Digit 29 — Damper w/ Fault Detection Diagnostics

- 0 = None
- 1 = Low Leak
- 2 = Ultra Low Leak

### Digit 30-35 — Future Use

- 0 = None

### Digit 36 — Hinged Access Doors

- A = Single Side

### Digit 37-38 — Future Use

- 0 = None

### Digit 39 — Ambient Control

- 0 = Standard
- 1 = Low Ambient w/Variable Speed Condenser Fan

### Digit 40 — Condenser Coil Coating

- A = None
- B = Corrosion Protected

### Digit 41 — Modulating Hot Gas Reheat & Hot Gas Bypass

- 0 = None
- 1 = Hot Gas Reheat
- 3 = Hot Gas Bypass
- 4 = Hot Gas Reheat & Hot Gas Bypass

### Digit 42 — Service Valves

- A = Discharge
- B = Compressor Isolation (Suction & Discharge)

### Digit 43 — Evaporator Coil Drain Pan

- 1 = Galvanized Steel
- 2 = Stainless Steel
- 3 = Galvanized Steel w/Condensate Overflow Switch
- 4 = Stainless Steel w/Condensate Overflow Switch

### Digit 44 — Power Supply

- 1 = Single Point

### Digit 45 — Unit Mounted Power Connection

- A = Terminal Block
- B = Non-Fused Disconnect
- C = Non-Fused Disconnect w/Powered Convenience Outlet

### Digit 46 — Communication Protocol

- 0 = None
- 1 = BACNet®
- 2 = Air-Fi™ Wireless
- 3 = LonTalk®
- 4 = Modbus

### Digit 47 — Power Monitor

- 0 = None
- 1 = Yes

### Digit 48 — Controls Expansion Hardware

- 0 = None
- A = Expansion Module

### Digit 49 — Rapid Restart

- 0 = None
- 1 = Yes

### Digit 50-57 — Future Use

- 0 = None

### Digit 58 — Agency Approval

- 1 = cULus Certification

### Digit 59-60 — Future Use

- 0 = None



# General Data

Table 1. General data – 20 to 50 ton

	20	25	30	40	50
<b>Compressor Data-Standard Capacity</b>					
Number/Size (Nominal)	1/5, 2/7.5	1/6, 2/9	1/6, 2/10	4/9	2/10.5, 2/11.5
Model	Scroll	Scroll	Scroll	Scroll	Scroll
Unit Capacity Steps (%)	100/75/38/25	100/63/25	100/62/24	100/75/50/25	100/73/50/23
No. of Circuits	1	1	1	2	2
<b>Compressor Data-High Capacity/High Efficiency</b>					
Number/Size (Nominal)	1/10.5, 1/11.5	1/11.5, 1/13.5	1/13.5, 1/15	4/9	2/10.5, 2/11.5
Model	Scroll	Scroll	Scroll	Scroll	Scroll
Unit Capacity Steps (%)	100/53/47	100/53/47	100/53/47	100/75/50/25	100/73/50/23
No. of Circuits	1	1	1	2	2
<b>Compressor Data-eFlex™ Variable Speed</b>					
Number/Size (Nominal)	1/3-13 VS, 1/9	1/3-13 VS, 1/10.5	1/4-17 VS, 1/13.5	1/4-17 VS, 2/9	1/6-25 VS, 2/11.5
Model	Scroll	Scroll	Scroll	Scroll	Scroll
Unit Capacity Steps (%)	15-100	15-100	15-100	15-100	15-100
No. of Circuits	1	1	1	2	2
<b>Air-Cooled Condenser Coil-Standard Capacity</b>					
Face area (ft <sup>2</sup> )	58	58	58	116	116
Rows/Fin Series	1/252	1/252	1/252	1/252	1/252
Type	Microchannel	Microchannel	Microchannel	Microchannel	Microchannel
<b>Air-Cooled Condenser Coil-High Capacity/High Efficiency</b>					
Face area (ft <sup>2</sup> )	58	58	58	116	116
Rows/Fin Series	1/252	1/252	2/252	1/252	2/252
Type	Microchannel	Microchannel	Microchannel	Microchannel	Microchannel
<b>Air-Cooled Condenser Coil-eFlex™ Variable Speed</b>					
Face area (ft <sup>2</sup> )	58	58	58	116	116
Rows/Fin Series	1/252	2/252	2/252	1/252	2/252
Type	Microchannel	Microchannel	Microchannel	Microchannel	Microchannel
<b>Air-Cooled Condenser Fans</b>					
Number/Size/Type	2/30"/Prop	2/30"/Prop	2/30"/Prop	4/30"/Prop	4/30"/Prop
Hp (each)	1.5	1.5	1.5	1.5	1.5
<b>Evaporator Coil-Standard Capacity</b>					
Face area (ft <sup>2</sup> )	30.2	30.2	30.2	35.7	35.7
Rows/Fin Series	3/168	2/168	4/168	3/168	4/168
Tube Diameter/Surface	1/2"/Enhanced	1/2"/Enhanced	1/2"/Enhanced	1/2"/Enhanced	1/2"/Enhanced
<b>Evaporator Coil-High Capacity/High Efficiency</b>					
Face area (ft <sup>2</sup> )	30.2	30.2	30.2	35.7	35.7
Rows/Fin Series	4/168	4/168	5/168	5/168	6/168
Tube Diameter/Surface	1/2"/Enhanced	1/2"/Enhanced	1/2"/Enhanced	1/2"/Enhanced	1/2"/Enhanced
<b>Evaporator Coil-eFlex™ Variable Speed</b>					
Face area (ft <sup>2</sup> )	30.2	30.2	30.2	35.7	35.7
Rows/Fin Series	4/168	5/168	5/168	6/168	5/168
Tube Diameter/Surface	1/2"/Enhanced	1/2"/Enhanced	1/2"/Enhanced	1/2"/Enhanced	1/2"/Enhanced
<b>Supply Fans - eDrive™ Direct Drive Plenum (DDP)</b>					
Number/Size Options	2- 16.5", 20.0", 22.2"	2- 16.5", 20.0", 22.2"	2- 16.5", 20.0", 22.2"	2- 18.2", 20.0", 24.5"	2- 18.2", 20.0", 24.5"
Number of Motors / VFDs	2	2	2	2	2
Hp Range	3, 6, 10, 15, 20, 30, 40	3, 6, 10, 15, 20, 30, 40	3, 6, 10, 15, 20, 30, 40	6, 10, 15, 20, 30, 40	6, 10, 15, 20, 30, 40



## General Data

**Table 1. General data – 20 to 50 ton (continued)**

	20	25	30	40	50
<b>Compressor Data-Standard Capacity</b>					
CFM Range	4,000 - 9,000	5,000 - 11,250	6,000 - 14,000	8,000 - 18,000	10,000 - 22,500
<b>Relief Fans - eDrive™ Motorized Impeller</b>					
Number/Size	1/23"	1/23", 1/25.5"	1/25.5", 2/23"	1/25.5", 2/23"	2/23", 2/25.5"
Number of Motors	1	1	1 or 2	1 or 2	2
hp Range	6 or 8	6 or 8	8 or 12	8 or 15	12 or 16
CFM Range	2,000-8,000	2,000-10,000	3,000-13,500	4,000-18,000	5,000-21,500
<b>Pre-Evap Filters</b>					
<b>2" MERV 4 Panel</b>					
Number/Size	4 - 16x20x2 6 - 20x20x2 2 - 20x24x2	4 - 16x20x2 6 - 20x20x2 2 - 20x24x2	4 - 16x20x2 6 - 20x20x2 2 - 20x24x2	3 - 20x20x2 7 - 20x24x2 2 - 24x24x2	3 - 20x20x2 7 - 20x24x2 2 - 24x24x2
Face area (ft <sup>2</sup> )	32.2	32.2	32.2	39.7	39.7
<b>2" MERV 8 Panel</b>					
Number/Size	4 - 16x20x2 6 - 20x20x2 2 - 20x24x2	4 - 16x20x2 6 - 20x20x2 2 - 20x24x2	4 - 16x20x2 6 - 20x20x2 2 - 20x24x2	3 - 20x20x2 7 - 20x24x2 2 - 24x24x2	3 - 20x20x2 7 - 20x24x2 2 - 24x24x2
Face area (ft <sup>2</sup> )	32.2	32.2	32.2	39.7	39.7
<b>4" MERV 8 Panel</b>					
Number/Size	4 - 16x20x4 6 - 20x20x4 2 - 20x24x4	4 - 16x20x4 6 - 20x20x4 2 - 20x24x4	4 - 16x20x4 6 - 20x20x4 2 - 20x24x4	3 - 20x20x4 7 - 20x24x4 2 - 24x24x4	3 - 20x20x4 7 - 20x24x4 2 - 24x24x4
Face area (ft <sup>2</sup> )	32.2	32.2	32.2	39.7	39.7
<b>4" MERV 14 Panel</b>					
Number/Size	4 - 16x20x4 6 - 20x20x4 2 - 20x24x4	4 - 16x20x4 6 - 20x20x4 2 - 20x24x4	4 - 16x20x4 6 - 20x20x4 2 - 20x24x4	3 - 20x20x4 7 - 20x24x4 2 - 24x24x4	3 - 20x20x4 7 - 20x24x4 2 - 24x24x4
Face area (ft <sup>2</sup> )	32.2	32.2	32.2	39.7	39.7
<b>2" MERV 8 Panel &amp; MERV 14 Cartridge</b>					
Cartridge - Number/Size	4 - 16x20x12 4 - 20x20x12 4 - 20x24x12	4 - 16x20x12 4 - 20x20x12 4 - 20x24x12	4 - 16x20x12 4 - 20x20x12 4 - 20x24x12	2 - 20x20x12 6 - 20x24x12 4 - 24x24x12	2 - 20x20x12 6 - 20x24x12 4 - 24x24x12
Face area (ft <sup>2</sup> )	33.3	33.3	33.3	41.6	41.6
Panel - Number/Size	4 - 16x20x2 4 - 20x20x2 4 - 20x24x2	4 - 16x20x2 4 - 20x20x2 4 - 20x24x2	4 - 16x20x2 4 - 20x20x2 4 - 20x24x2	2 - 20x20x2 6 - 20x24x2 4 - 24x24x2	2 - 20x20x2 6 - 20x24x2 4 - 24x24x2
Face area (ft <sup>2</sup> )	33.3	33.3	33.3	41.6	41.6
<b>Final Filters</b>					
<b>2" MERV 8 Panel &amp; MERV 14 Cartridge</b>					
Cartridge - Number/Size	4 - 16x20x12 4 - 20x20x12 4 - 20x24x12	4 - 16x20x12 4 - 20x20x12 4 - 20x24x12	4 - 16x20x12 4 - 20x20x12 4 - 20x24x12	4 - 20x20x12 6 - 20x24x12 2 - 24x24x12	4 - 20x20x12 6 - 20x24x12 2 - 24x24x12
Face area (ft <sup>2</sup> )	33.3	33.3	33.3	39.1	39.1
Panel - Number/Size	4 - 16x20x2 4 - 20x20x2 4 - 20x24x2	4 - 16x20x2 4 - 20x20x2 4 - 20x24x2	4 - 16x20x2 4 - 20x20x2 4 - 20x24x2	4 - 20x20x2 6 - 20x24x2 2 - 24x24x2	4 - 20x20x2 6 - 20x24x2 2 - 24x24x2
Face area (ft <sup>2</sup> )	33.3	33.3	33.3	39.1	39.1
<b>Standard Unit Minimum Outside Air Temperature for Mechanical Cooling</b>					
Economizer - A/C Applications (fixed speed/eFlex™)	45°F/45°F	45°F/50°F	45°F/50°F	45°F/50°F	45°F/50°F
No Economizer - 80/67°F design return air (fixed speed/eFlex™)	45°F/45°F	45°F/55°F	45°F/55°F	45°F/55°F	45°F/55°F
No Economizer - 90/78°F design return air (fixed speed/eFlex™)	55°F/55°F	55°F/70°F	55°F/70°F	55°F/70°F	55°F/70°F
<b>Low Ambient Unit Minimum Outside Air Temperature for Mechanical Cooling</b>					
Without Hot Gas Bypass	0°F	0°F	0°F	0°F	0°F
With Hot Gas Bypass	10°F	10°F	10°F	10°F	10°F



**Table 2. General data – 55 to 75 ton**

	<b>55</b>	<b>60</b>	<b>70</b>	<b>75</b>
<b>Compressor Data-Standard Capacity</b>				
Number/Size (Nominal)	4/11.5	2/13.5, 2/15	4/15	4/15
Model	Scroll	Scroll	Scroll	Scroll
Unit Capacity Steps (%)	100/75/50/25	100/73/50/23	100/75/50/25	100/75/50/25
No. of Circuits	2	2	2	2
<b>Compressor Data-High Capacity/High Efficiency</b>				
Number/Size (Nominal)	2/10.5, 2/11.5	4/13.5	2/13.5, 2/15	4/15
Model	Scroll	Scroll	Scroll	Scroll
Unit Capacity Steps (%)	100/73/50/23	100/75/50/25	100/73/50/23	100/75/50/25
No. of Circuits	2	2	2	2
<b>Compressor Data-eFlex™ Variable Speed</b>				
Number/Size (Nominal)	1/6-25 VS, 2/11.5	1/6-25 VS, 2/15	1/6-25 VS, 2/15	1/6-25 VS, 1/15.5, 2/13.5
Model	Scroll	Scroll	Scroll	Scroll
Unit Capacity Steps (%)	15-100	15-100	15-100	15-100
No. of Circuits	2	2	2	2
<b>Air-Cooled Condenser Coil-Standard Capacity</b>				
Face area (ft <sup>2</sup> )	116	136	136	136
Rows/Fin Series	1/252	1/252	1/252	1/252
Type	Microchannel	Microchannel	Microchannel	Microchannel
<b>Air-Cooled Condenser Coil-High Capacity/High Efficiency</b>				
Face area (ft <sup>2</sup> )	116	136	136	136
Rows/Fin Series	2/252	1/252	2/252	2/252
Type	Microchannel	Microchannel	Microchannel	Microchannel
<b>Air-Cooled Condenser Coil-eFlex™ Variable Speed</b>				
Face area (ft <sup>2</sup> )	116	136	136	136
Rows/Fin Series	2/252	1/252	2/252	2/252
Type	Microchannel	Microchannel	Microchannel	Microchannel
<b>Air-Cooled Condenser Fans</b>				
Number/Size/Type	4/30"/Prop	6/26"/Prop	6/26"/Prop	6/26"/Prop
Hp (each)	1.5	1	1	1
<b>Evaporator Coil-Standard Capacity</b>				
Face area (ft <sup>2</sup> )	35.7	46.3	46.3	46.3
Rows/Fin Series	5/168	3/168	5/168	6/168
Tube Diameter/Surface	1/2"/Enhanced	1/2"/Enhanced	1/2"/Enhanced	1/2"/Enhanced
<b>Evaporator Coil-High Capacity/High Efficiency</b>				
Face area (ft <sup>2</sup> )	35.7	46.3	46.3	46.3
Rows/Fin Series	6/168	6/168	6/168	6/168
Tube Diameter/Surface	1/2"/Enhanced	1/2"/Enhanced	1/2"/Enhanced	1/2"/Enhanced
<b>Evaporator Coil-eFlex™ Variable Speed</b>				
Face area (ft <sup>2</sup> )	35.7	46.3	46.3	46.3
Rows/Fin Series	5/168	6/168	6/168	6/168
Tube Diameter/Surface	1/2"/Enhanced	1/2"/Enhanced	1/2"/Enhanced	1/2"/Enhanced
<b>Supply Fans - eDrive™ Direct Drive Plenum (DDP)</b>				
Number/Size Options	2- 18.2", 20.0", 24.5"	2- 22.2", 27.0"	2- 22.2", 27.0"	2- 22.2", 27.0"
Number of Motors / VFDs	2	2	2	2
Hp Range	6, 10, 15, 20, 30, 40	6, 10, 15, 20, 30, 40, 50	6, 10, 15, 20, 30, 40, 50	6, 10, 15, 20, 30, 40, 50
CFM Range	11,000 - 24,750	12,000 - 27,000	14,000 - 30,000	15,000 - 30,000
<b>Relief Fans - eDrive™ Motorized Impeller</b>				
Number/Size	2/23", 2/25.5"	2/25.5", 3/23"	2/25.5", 3/23"	2/25.5", 3/23"



## General Data

**Table 2. General data – 55 to 75 ton (continued)**

	55	60	70	75
<b>Compressor Data-Standard Capacity</b>				
Number of Motors	2	2 or 3	2 or 3	2 or 3
hp Range	12 or 16	16 or 23	16 or 23	16 or 23
CFM Range	5,000-21,500	6,000-28,000	6,000-28,000	6,000-28,000
<b>Pre-Evap Filters</b>				
<b>2" MERV 4 Panel</b>				
Number/Size	3 - 20x20x2 7 - 20x24x2 2 - 24x24x2	2 - 20x20x2 7 - 20x24x2 6 - 24x24x2	2 - 20x20x2 7 - 20x24x2 6 - 24x24x2	2 - 20x20x2 7 - 20x24x2 6 - 24x24x2
Face area (ft <sup>2</sup> )	39.7	52.9	52.9	52.9
<b>2" MERV 8 Panel</b>				
Number/Size	3 - 20x20x2 7 - 20x24x2 2 - 24x24x2	2 - 20x20x2 7 - 20x24x2 6 - 24x24x2	2 - 20x20x2 7 - 20x24x2 6 - 24x24x2	2 - 20x20x2 7 - 20x24x2 6 - 24x24x2
Face area (ft <sup>2</sup> )	39.7	52.9	52.9	52.9
<b>4" MERV 8 Panel</b>				
Number/Size	3 - 20x20x4 7 - 20x24x4 2 - 24x24x4	2 - 20x20x4 7 - 20x24x4 6 - 24x24x4	2 - 20x20x4 7 - 20x24x4 6 - 24x24x4	2 - 20x20x4 7 - 20x24x4 6 - 24x24x4
Face area (ft <sup>2</sup> )	39.7	52.9	52.9	52.9
<b>4" MERV 14 Panel</b>				
Number/Size	3 - 20x20x4 7 - 20x24x4 2 - 24x24x4	2 - 20x20x4 7 - 20x24x4 6 - 24x24x4	2 - 20x20x4 7 - 20x24x4 6 - 24x24x4	2 - 20x20x4 7 - 20x24x4 6 - 24x24x4
Face area (ft <sup>2</sup> )	39.7	52.9	52.9	52.9
<b>2" MERV 8 Panel &amp; MERV 14 Cartridge</b>				
Cartridge - Number/Size	2 - 20x20x12 6 - 20x24x12 4 - 24x24x12	2 - 20x20x12 7 - 20x24x12 6 - 24x24x12	2 - 20x20x12 7 - 20x24x12 6 - 24x24x12	2 - 20x20x12 7 - 20x24x12 6 - 24x24x12
Face area (ft <sup>2</sup> )	41.6	52.9	52.9	52.9
Panel - Number/Size	2 - 20x20x2 6 - 20x24x2 4 - 24x24x2	2 - 20x20x2 7 - 20x24x2 6 - 24x24x2	2 - 20x20x2 7 - 20x24x2 6 - 24x24x2	2 - 20x20x2 7 - 20x24x2 6 - 24x24x2
Face area (ft <sup>2</sup> )	41.6	52.9	52.9	52.9
<b>Final Filters</b>				
<b>2" MERV 8 Panel &amp; MERV 14 Cartridge</b>				
Cartridge - Number/Size	4 - 20x20x12 6 - 20x24x12 2 - 24x24x12	4 - 20x20x12 8 - 20x24x12 3 - 24x24x12	4 - 20x20x12 8 - 20x24x12 3 - 24x24x12	4 - 20x20x12 8 - 20x24x12 3 - 24x24x12
Face area (ft <sup>2</sup> )	39.1	49.8	49.8	49.8
Panel - Number/Size	4 - 20x20x2 6 - 20x24x2 2 - 24x24x2	4 - 20x20x2 8 - 20x24x2 3 - 24x24x2	4 - 20x20x2 8 - 20x24x2 3 - 24x24x2	4 - 20x20x2 8 - 20x24x2 3 - 24x24x2
Face area (ft <sup>2</sup> )	39.1	49.8	49.8	49.8
<b>Standard Unit Minimum Outside Air Temperature for Mechanical Cooling</b>				
Economizer - A/C Applications (fixed speed/eFlex™)	45°F/50°F	45°F/45°F	45°F/45°F	45°F/45°F
No Economizer - 80/67°F design return air (fixed speed/eFlex™)	45°F/55°F	45°F/45°F	45°F/45°F	45°F/45°F
No Economizer - 90/78°F design return air (fixed speed/eFlex™)	55°F/70°F	55°F/55°F	55°F/55°F	55°F/55°F
<b>Low Ambient Unit Minimum Outside Air Temperature for Mechanical Cooling</b>				
Without Hot Gas Bypass	0°F	0°F	0°F	0°F
With Hot Gas Bypass	10°F	10°F	10°F	10°F

**Table 3. Electric heating – general data**

Electric Heat	20 - 30 Tons			40 - 55 Tons				60 - 75 Tons		
	30	60	90	60	90	120	150	90	120	190
kW Range	30	60	90	60	90	120	150	90	120	190
Capacity Steps	2	4	3	4	3	4	4	3	4	5

**Table 4. Natural gas heating – general data**

Natural Gas Heat	20 - 30 Tons			40 - 55 Tons			60 - 75 Tons		
	Low	Med	High	Low	Med	High	Low	Med	High
MBh Input	250	350	500	350	500	850	500	850	1200
Efficiency (%)	81	81	81	81	81	81	81	81	81
Standard:									
Capacity Steps	2	2	2	2	2	4	2	4	4
Modulating:									
Standard Turndown	5:1	5:1	10:1	5:1	10:1	10:1	10:1	10:1	11:1
Ultra Turndown	9:1	11:1	16:1	11:1	16:1	20:1	16:1	20:1	21:1
Gas Connection Pipe Size (in.)	1	1	1	1	1	1-1/4	1	1-1/4	1-1/2

**Table 5. EER/IEER ratings**

Tons	Refrigeration System Performance	EER			CV IEER			VAV IEER		
		460V_CO	460V_EH	460V_GH	460V_CO	460V_EH	460V_GH	460V_CO	460V_EH	460V_GH
20	Std	10.8	10.8	10.7	11.7	11.7	11.5	13.7	13.7	13.5
	High Eff	11.4	11.4	11.3	15.0	14.9	14.8	15.0	15.0	15.0
	Variable_Stage	11.4	11.4	11.3				16.5	16.5	16.4
	Variable_LA	11.4	11.4	11.3				17.2	17.2	17.2
25	Std	10.3	10.2	10.1	11.7	11.7	11.5	13.9	13.9	13.7
	High Eff	11.2	11.2	11.1	14.7	14.6	14.3	15.5	15.4	15.3
	Variable_Stage	11.3	11.3	11.2				17.1	17.0	17.0
	Variable_LA	11.3	11.3	11.2				18.0	17.9	17.8
30	Std	10.7	10.7	10.5	11.7	11.7	11.5	13.9	13.9	13.7
	High Eff	11.1	11.1	10.9	14.4	14.2	13.9	15.8	15.8	15.6
	Variable_Stage	11.1	11.0	10.9				17.3	17.2	17.1
	Variable_LA	11.1	11.0	10.9				18.1	18.0	17.9
40	Std	10.3	10.2	10.0	11.7	11.7	11.5	14.4	14.4	14.2
	High Eff	11.2	11.1	10.9	13.7	13.4	13.0	15.3	15.2	15.1
	Variable_Stage	11.1	11.0	10.8				15.9	15.8	15.7
	Variable_LA	11.1	11.0	10.8				15.8	15.7	15.6
50	Std	10.3	10.1	9.9	11.7	11.7	11.5	14.4	14.4	14.2
	High Eff	11.2	11.1	10.9	13.6	13.2	12.7	15.2	15.1	14.9
	Variable_Stage	11.2	11.0	10.7				16.8	16.7	16.5
	Variable_LA	11.1	11.0	10.7				16.9	16.8	16.6
55	Std	10.3	10.1	9.9	11.7	11.7	11.5	14.1	14.1	13.9
	High Eff	11.1	11.0	10.8	13.9	13.6	13.1	15.0	14.9	14.8
	Variable_Stage	11.1	10.9	10.7				16.7	16.5	16.4
	Variable_LA	11.1	10.9	10.7				16.8	16.6	16.5
60	Std	10.4	10.2	9.9	11.7	11.7	11.5	14.9	14.9	14.7
	High Eff	11.3	11.1	10.8	13.3	12.8	12.1	16.2	16.0	15.7
	Variable_Stage	11.1	10.9	10.7				16.6	16.5	16.3
	Variable_LA	11.1	10.9	10.7				16.9	16.8	16.5
70	Std	10.3	10.0	9.6	11.3	11.3	11.1	15.1	15.1	14.9
	High Eff	11.6	11.3	10.7	14.1	13.2	12.0	17.0	16.7	16.1
	Variable_Stage	11.5	11.2	10.7				17.0	16.7	16.2
	Variable_LA	11.5	11.2	10.6				18.1	17.8	17.3



## General Data

**Table 5. EER/IEER ratings (continued)**

Tons	Refrigeration System Performance	EER			CV IEER			VAV IEER		
		460V_CO	460V_EH	460V_GH	460V_CO	460V_EH	460V_GH	460V_CO	460V_EH	460V_GH
75	Std	10.4	10.1	9.6	11.3	11.3	11.1	14.7	14.7	14.5
	High Eff	11.5	11.3	10.8	14.6	13.8	12.7	16.8	16.5	16.1
	Variable_Stage	11.5	11.3	10.9				17.9	17.7	16.7
	Variable_LA	11.5	11.3	10.9				17.8	17.6	17.3

**Notes:**

1. CO = Cooling Only, EH = Electric Heat, GH = Gas Heat
2. Cooling performance is rated at 95°F ambient, 80°F entering dry bulb, 67°F entering wet bulb. Gross capacity does not include the effect of fan motor heat. AHRI capacity is net and includes the effect of fan motor heat. Units are suitable for operation to +/- 20% of nominal CFM. Units are certified in accordance with the Unitary Air Conditioner Equipment certification program, which is based on AHRI Standard 340/360.
3. EER and/or IEER are rated at AHRI conditions and in accordance with DOE test procedures.
4. For simplified verification of your specific unit EER/IEER, and capacity at operating conditions, it is strongly recommended that a TOPSS™ (Trane product selection program) report is run.
5. "Variable\_Stage" means variable speed combined with standard ambient condenser fan control option. "Variable\_LA" means variable speed combined with low ambient condenser fan control.

**Table 6. Economizer outdoor air damper leakage (at rated airflow, cfm/sq ft)**

<b>ΔP Across Dampers (in. wc)</b>	<b>1.0</b>
<b>Low Leak</b>	10
<b>Ultra Low Leak</b>	4

**Notes:**

1. Above data for Standard and Low Leak based on tests completed in accordance with AMCA Standard 500-D
2. All dampers meet California Title 24 requirements.



# Symbio™ 800 Controls

## Overview

The Symbio™ 800 controller is a factory-installed, application specific and programmable controller designed to control chillers and large packaged HVAC equipment. A 7" user interface features a touch-sensitive color screen that provides facility managers at-a-glance operating status, performance monitoring, scheduling changes, and operating adjustments. Other advanced features include automated controller back-up, and optional features such as secure remote connectivity, wireless building communications, mobile device connectivity, and custom programming with expandable I/O.

Symbio™ 800 Advantages		Benefits
Connected	Convenient, on-the-go access to advanced monitoring, troubleshooting, and energy management	<ul style="list-style-type: none"> <li>• Minimum first cost</li> <li>• Maximum comfort</li> <li>• Minimized downtime</li> <li>• Minimum operating costs</li> <li>• Superior building and occupant productivity</li> </ul>
Flexible	Minimized installation hardware and labor costs – able to use existing devices for maximum convenience, lower controls upgrades and relocation	
Reliable	Maximum equipment uptime and life, minimized maintenance and troubleshooting cost	

## Features and Benefits

Symbio™ 800 Feature	Benefits
Multiple, open standard protocol support <ul style="list-style-type: none"> <li>• Air-Fi™ Wireless (BACnet/AirFi®, optional)</li> <li>• BACnet MS/TP</li> <li>• BACnet/IP</li> <li>• LON (Optional)</li> <li>• Modbus</li> </ul>	Simplified, lower cost, and more flexible integration with all common open standard protocols using Trane or competitive BAS systems and controllers
Remote connection to building or equipment	Trane Connect™ provides an easy, secure option to connect remotely to a Tracer SC+ or directly to your Trane equipment
Common integration strategies and equipment specific points lists	Simplified, lower cost, and uncompromised integration
Application specific and configurable	Reduced project costs with superior reliability, comfort, performance - applications specific and configurable system ensures machine continues to run within operating envelope. Ability to upgrade firmware with a simple file transfer.
Smart Analytics	Smart analytics provide superior reliability through the life of the equipment with minimum downtime
Data logging	Standard, local or remote Intuitive review and analysis of equipment, zone, and building performance
Local scheduling	Capable of operating in stand-alone operation without a building automation system as a temporary back-up schedule for ongoing comfort and energy savings
Rugged, 7-inch color touch screen user interface	Easy, touch navigation for viewing data and making operational changes
Display preferences	Choose how to view dates, times, units (SI, IP), screen brightness, data format, and backlight timeout. 3 built-in languages are supported and selectable for all TD7 screens.
Intuitive navigation	Helps operators access data and alarms for quick and accurate response and resolution
At-a-glance status	Easily readable color display showing key operating parameters of major equipment components
Reports	Quickly summarizes data for clear understanding and interpretation to enable local monitoring of expected performance and operating efficiency



## Symbio™ 800 Controls

Symbio™ 800 Feature	Benefits
Graphs	Easily visualize trend data for local troubleshooting and fine-tuning
Multiple language support	Suitable for operation in multiple geographies
Adaptive Control™ Algorithms	Pre-empts potential equipment disruptions during rapidly changing conditions – providing consistent equipment performance and building comfort
SD card backup/restore	Faster, lower cost repairs with reduced downtime
Modbus device support	Capable of integrating optional Modbus devices for local or remote diagnostics – provides faster, lower cost troubleshooting and increased equipment performance

## Options

Symbio™ 800 Feature	Benefits
Remote connection to building or equipment	Trane Connect™ provides an easy, secure option to connect remotely to a Tracer SC+ or directly to your Trane equipment
Programmable	Equipment application flexibility and cost-reduced control of nearby equipment
Expandable I/O	Field or factory installed I/O for programmable feature - Reduced installation costs and increased installation flexibility
User security with audit trail support	Flexible and secure access for multiple users allows monitoring, overriding/releasing points, release of all overrides, custom report editing, and tracking changes by user
Wi-Fi Adapter	Enables the operation of wireless service tools for increased technician productivity and flexibility
LonTalk	
Air-Fi™ Wireless (BACnet, optional)	

## Supply Air Pressure Control

### Variable Frequency Drive (VFD) Control

Variable frequency drives are used for supply fan speed control. A pressure transducer measures duct static pressure, and the VFD is modulated to maintain the supply air static pressure within an adjustable user-defined range. The range is determined by the supply air pressure setpoint and supply air pressure deadband, which are set through the User Interface or BAS/Network.

The variable frequency drives provide supply fan motor speed modulation. The drive will accelerate or decelerate as required to maintain the supply static pressure setpoint.

### Supply Air Static Pressure Limit

The opening of VAV terminals, and the amount of supply air provided by the variable frequency drive are coordinated during start up and transition to/from Occupied/Unoccupied modes to prevent over pressurization of the supply air ductwork. However, if for any reason the supply air pressure exceeds the user-defined supply air static pressure limit that was set at the User Interface, the supply fan and VFD are shut down. The unit is then allowed to restart three times. If the over pressurization condition occurs on the third restart, the unit is shut down and a manual reset diagnostic is set and displayed at the User Interface and BAS/Network.

## Supply Air Temperature Controls

### Cooling/Economizer

During Occupied cooling mode of operation, the economizer (if available) and mechanical cooling are used to control the supply air temperature. The supply air temperature setpoint and deadband are user-defined at the User Interface. The supply air temperature setpoint may be user-defined from the BAS/Network. If the conditions of the outside air are appropriate to use “free cooling,” the economizer will be used first in an attempt to satisfy the supply air setpoint;

then, if required, the mechanical cooling will be staged on to maintain supply air temperature setpoint. Minimum On/Off timing of the mechanical cooling prevents rapid cycling.

On units with economizer, a call for cooling will modulate the outside air dampers open. The rate of economizer modulation is based on deviation of the supply air temperature from setpoint, i.e., the further away from setpoint, the faster the outside air damper will open. First stage of cooling will be allowed to start after the economizer reaches full open.

The economizer is only allowed to function freely if one of the following conditions is met:

- For dry bulb economizer control the ambient temperature must be below the dry bulb temperature control setting.
- For reference enthalpy economizer control, outdoor air enthalpy must be below the enthalpy control setting. At outdoor air conditions above the enthalpy control setting, mechanical cooling only is used and the outside air dampers remain at minimum position.
- For comparative enthalpy economizer control, outdoor air enthalpy must be below the enthalpy of the return air.

If the unit does not include an economizer, mechanical cooling only is used to satisfy cooling requirements. The outdoor air dampers may be set for a maximum of 25% outdoor air, through a manually operated damper.

## Heating

### Modulating Gas

Modulating the gas heat output provides an improved discharge air temperature control, giving customers improved zone control. Modulating gas heat consists of a modulating bank of heat, and up to three additional fixed stages of heat – providing continuous modulation across the heaters range of output. Status and diagnostic messages are communicated to the Symbio™ 800 and presented to users on the user interface.

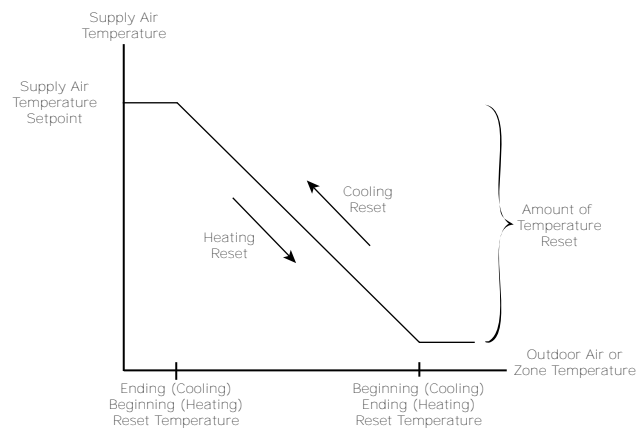
### Electric Heating

The individual stages of electric heat will be sequenced on the zone demand. The number of available stages will depend on the unit voltage and heat capacity selected.

For units with SCR electric heat, the first stage is modulating. The modulating stage and the necessary additional stages are sequenced to precisely meet the zone demand.

### Discharge Air Setpoint Reset

**Figure 8. Supply air temperature reset**



Discharge air setpoint reset can be used to adjust the discharge air temperature setpoint on the basis of a zone temperature or on outdoor air temperature. Discharge air setpoint reset adjustment is available from the User Interface for supply air heating and supply air cooling control.

### Outdoor air cooling reset



Outdoor air cooling reset is sometimes used in applications where the outdoor temperature has a large effect on building load. When the outside air temperature is low and the building cooling load is low, the discharge air setpoint can be raised, thereby preventing sub-cooling of critical zones. This reset can lower usage of mechanical cooling, thus savings in compressor kW, but an increase in supply fan kW may occur.

### **Outdoor air heating reset**

Outdoor air heating reset is the inverse of cooling, with the same principles applied. For both outdoor air cooling reset and heating reset, there are three user-defined parameters that are adjustable through the User Interface:

- Beginning reset temperature
- Ending reset temperature
- Amount of temperature reset

### **Zone reset**

Zone reset is applied to the zone(s) in a building that tend to be overly cool or overly hot. The supply air temperature setpoint is adjusted based on the temperature of the critical zone(s). This can have the effect of improving comfort and/or lowering energy usage. The user-defined parameters are the same as for outdoor air reset.

### **Supply Air Tempering**

A feature that is used with modulating gas option. Supply air tempering is enabled when the supply air temperature falls below the supply air temperature deadband low end. The heat valve is then modulated open to maintain the set minimum supply air temperature.

## **Zone Temperature Control**

### **Unoccupied Zone Heating and Cooling**

During Unoccupied mode, the unit is operated as a CV unit. Supply fan VFDs operate at 100% and VAV boxes are driven full open. The unit controls zone temperature within the Unoccupied zone cooling and heating (heating units only) setpoints.

### **Daytime Warm-up**

This feature is available on all types of heating units. During Occupied mode, if the zone temperature falls to a preset, user-defined zone low limit temperature setpoint, the unit is put into Unoccupied mode and Daytime Warm-up is initiated. The system changes over to CV heating (full unit airflow), the VAV boxes are fully opened and full heating capacity is provided until the Daytime Warm-up setpoint is reached. The unit is then returned to normal Occupied mode.

### **Outside Air Measurement**

Trane air quality (TraQ™) outside air measurement system utilizes velocity pressure sensing rings. Based on unit design CFM, the Symbio™ 800 monitors and controls the quantity of outside air entering the unit. The outside airflow can be calibrated to compensate for altitude.

An optional CO<sub>2</sub> sensor may be connected to control outside air based on CO<sub>2</sub> Demand Control Ventilation (DCV).

### **Unit Feedback – Supply and Relief Fan Speed Setpoints**

Controls VAV Unit Feedback Setpoints BACnet® network points are available to allow for communication of the Supply and Relief Fan Speed Setpoints to the BAS. These points are only available for multi-zone VAV units. These setpoints will be overridden by equipment protection functionality, when applicable.

### **Outside Air Flow Compensation**

As the supply fan modulates, this function proportionally adjusts the economizer minimum position to compensate for the change in total airflow, in order to maintain a constant percent of



outside air. The modified economizer minimum position is computed as a linear function, based on VFD position, given the two endpoints:

- Minimum Position with VFD @ 0%
- Minimum Position with VFD @ 100%

Both are user adjustable at the User Interface.

## Single Zone Variable Air Volume (SZVAV) Only

The IntelliPak® controls platform will support Single Zone VAV as an optional unit control type in order to meet ASHRAE 90.1. The basic control will be a hybrid VAV/CV configured unit that provides discharge temperature control to a varying discharge air temperature target setpoint based on the space temperature and/or humidity conditions. Concurrently, the unit will control and optimize the supply fan speed to maintain the zone temperature to a zone temperature setpoint.

### VFD Control

The VFD will modulate the supply fan motor speed, accelerating or decelerating as required to maintain the zone temperature to the zone temperature setpoint. When subjected to high ambient return conditions the VFD will reduce its output frequency to maintain operation.

### Supply Fan Output Control

Units configured for Single Zone VAV control will utilize the same supply fan output control scheme as on traditional VAV units except the VFD signal will be based on zone heating and cooling demand instead of the supply air pressure.

### Space Pressure Control

For units configured with Space Pressure Control with or without Statitrac, the new schemes implemented for economizer minimum position handling require changes to the existing Space Pressure Control scheme in order to prevent over/under pressurization. The overall scheme will remain very similar to VAV units with Space Pressure Control with the exception of the dynamic Relief Enable Setpoint.

For SZVAV a Relief Enable Setpoint must be selected during the 100% Fan Speed Command. Once selected, the difference between the Relief Enable Setpoint and Design OA Damper Minimum Position at 100% Fan Speed Command will be calculated. The difference calculated will be used as an offset and added to the Active Building Design OA Minimum Position Target in order to calculate the dynamic Relief Enable Target, which will be used throughout the Supply Fan Speed/OA Damper Position range.

The Relief Enable Target could be above or below the Active Building Design OA Minimum Position Target Setpoint, based on the Active Relief Enable Setpoint being set above or below the Building Design Minimum Position at 100% Fan Speed Command. Note that an Relief Enable Setpoint of 0% will result in the same effect on Relief Fan control as on VAV applications with and without Statitrac.

### Occupied Cooling Operation

For normal cooling operation, cooling capacity will be staged or modulated in order to meet the calculated discharge air target setpoint. If the current active cooling capacity is controlling the discharge air within the deadband, no additional cooling capacity change will be requested. As the Discharge Air Temperature rises above the deadband, the algorithm will request additional capacity as required (additional compressors or economizer). As the Discharge Air Temperature falls below the deadband, the algorithm will request a reduction in active capacity.

### Default Economizer Operation

By default, the unit will be setup to optimize the minimum supply fan speed capability during Economizer Only operation. If the economizer is able to meet the demand alone, due to desirable ambient conditions, the supply fan speed will be allowed to increase above the minimum prior to



utilizing mechanical cooling if discharge air setpoint falls below the discharge air Lower Limit (Cooling) setpoint.

### Unoccupied Mode

In Unoccupied periods the unit will utilize setback setpoints, 0% Minimum OA Damper position, and Auto Fan Mode operation as on normal Constant Volume units. The Supply Fan speed will be forced to 100% for all active heating and cooling requests in this mode.

### Occupied Heating Operation

Occupied heating operation will utilize two separate control methodologies based on heating configurations. For all “Staged” Heating types, the unit will utilize full airflow during all active heating periods exactly like traditional Constant Volume units. For “Modulating” Heating types the unit will have the ability to utilize SZVAV Heating, much like Active Cooling, in order to maintain the Zone Temperature to the Zone Heating setpoint. Also, on units configured with a Modulating Heat type, the customer will have the ability to select between SZVAV Heating control, or to utilize traditional Constant Volume, full airflow heating based on the associated unit setup.

### Cooling Sequence

If the controller determines that there is a need for compressor stages in order to meet the calculated discharge air target setpoint, once supply fan proving has been made, the unit will begin to stage compressors accordingly.

**Note:** *The compressor staging order will be based on unit configuration and compressor balanced starts status.*

Once the discharge air target setpoint calculation has reached the user define Minimum Setpoint and compressors are being utilized to meet the demand, if the cooling demand increases, the discharge air target setpoint value will continue to lower past the minimum setpoint and begin to ramp the supply fan speed upward toward 100%.

Once the discharge air target setpoint calculation has reached the Minimum Setpoint and compressors are being utilized to meet the demand, as the discharge air target setpoint value continues to calculate lower the algorithm will begin to ramp the supply fan speed up toward 100%. Note that the supply fan speed will remain at the compressor stage’s associated minimum value (as described below) until the discharge air target setpoint value is calculated below the discharge air temperature Minimum Setpoint (limited discharge air target setpoint).

As the cooling load in the zone decreases the zone cooling algorithm will reduce the speed of the fan down to minimum per compressor stage and control the compressors accordingly. As the compressors begin to de-energize, the supply fan speed will fall back to the Cooling Stage’s associated minimum fan speed, but not below. As the load in the zone continues to drop, cooling capacity will be reduced in order to maintain the discharge air within the  $\pm\frac{1}{2}$  discharge air target deadband.

## Constant Volume (CV) Only

### Occupied Zone Temperature Control

#### Cooling/Economizer

During Occupied cooling mode, the economizer (if provided) and mechanical cooling are used to control zone temperature. The zone temperature cooling setpoint is user-defined at the User Interface or from the BAS/Network. If the conditions of outside air is appropriate to use “free cooling”, the economizer will be first be used to attempt to satisfy the cooling zone temperature setpoint; then the compressors will be staged up as necessary. Minimum on/off timing of compressors prevents rapid cycling.

On units with economizer, a call for cooling will modulate the outside air dampers open. The rate of economizer modulation is based on deviation of the zone temperature from setpoint, i.e., the further away from setpoint, the faster the outside air damper will open. First stage of cooling will be allowed to start after the economizer reaches full open.

The economizer is only allowed to function freely if one of the following conditions is met:

- For dry bulb economizer control, the ambient temperature must be below the dry bulb temperature control setting.
- For reference enthalpy economizer control, outdoor air enthalpy must be below the enthalpy control setting. At outdoor air conditions above the enthalpy control setting, mechanical cooling only is used and the outdoor air dampers remain at minimum position.
- For comparative enthalpy economizer control, outdoor air enthalpy must be below the enthalpy of the return air.

If the unit does not include an economizer, mechanical cooling only is used to satisfy cooling requirements.

## Heating

### Gas Heating: Staged Heat

Up to four stages of gas heat will be sequenced based on zone demand. Status messages and diagnostics are communicated to the user interface.

### Gas Heating: Modulating Gas

Modulating gas heat will consist of one modulating bank and up to 3 fixed stages of heat for precise heating control. The output will be modulated as the demand in the zone changes. Status and diagnostic messages are communicated to the user interface.

### Electric Heating

The individual stages of electric heat will be sequenced on the zone demand. The number of available stages will depend on the unit voltage and heat capacity selected.

For units with SCR electric heat, the first stage is modulating. The modulating stage and the necessary additional stages are sequenced to precisely meet the zone demand.

## Auto Changeover

When the System Mode is "Auto," the mode will change to cooling or heating as necessary to satisfy the zone cooling and heating setpoints. The zone cooling and heating setpoints can be as close as 2°F apart.

## Unoccupied Zone Temperature Control

### Cooling and Heating

Cooling and/or heating modes can be selected to maintain Unoccupied zone temperature setpoints. For Unoccupied periods, heating, economizer operation or compressor operation can be selectively locked out at the User Interface.

## CV, SZVAV, and VAV

*Note: SZVAV exceptions are noted in parenthesis.*

## Space Pressure Control - Statitrac

A pressure transducer is used to measure and report direct space (building) static pressure. The user-defined control parameters used in this control scheme are space static pressure setpoint, space pressure deadband and relief enable point. As the economizer opens, the building pressure rises and once above the relief enable point, enables the relief fan and dampers. The relief dampers or relief fan then modulate to maintain space pressure within the deadband.

## Morning Warm-up Options (Not applicable to SZVAV)

This feature may be enabled on all types of factory installed heat units as well as cooling only units configured as "External Heat" (for example, VAV boxes with reheat). At the conclusion of Unoccupied mode, while the economizer (if supplied) is kept closed, the selected zone is heated



to the user-defined Morning Warm-up setpoint (see description below). The unit is then released to Occupied mode.

### **Cycling Capacity Morning Warm-up (MWU)**

Cycling capacity Morning Warm-up provides a more gradual heating of the zone. Normal zone temperature control with varying capacity is used to raise the zone temperature to the MWU zone temperature setpoint. This method of warm-up is used to overcome the “building sink” effect. Cycling capacity MWU will operate until the MWU setpoint is reached or for 60 minutes, then the unit switches to Occupied mode. A control algorithm is used to increase or decrease the amount of heat in order to achieve the MWU zone temperature setpoint.

**Note:** *When using the Morning Warm-up option in a VAV heating/cooling rooftop, airflow must be maintained through the rooftop unit. This can be accomplished by electrically tying the VAV boxes to the VAV box output relay contacts on the Symbio™ 800 Controls or by using changeover thermostats. Either of these methods will assure adequate airflow through the unit and satisfactory heating of the building.*

## **Emergency Override**

When a LonTalk® communication protocol or BACnet® control network is installed, the user can initiate from the Tracer® Ensemble™ building automation system (BAS), Tracer® SC+ or third party BAS one of five predefined, not available to configure, Emergency Override sequences. All compressors and condenser fans are de-energized for any Emergency Override sequence. Each Emergency Override sequence commands the unit operation as follows:

### **PRESSURIZE\_EMERG:**

- Supply Fan VFD - Max
- Relief Fan - Off; Relief Dampers - Closed (if so equipped)
- OA Dampers - Open; Return Damper - Closed
- Heat - All heat stages off; Mod Heat output Off
- Occupied/Unoccupied/VAV box output - Energized
- VOM Relay - Energized (if so equipped)

### **EMERG\_DEPRESSURIZE:**

- Supply Fan VFD - Min
- Relief Fan - On; Relief Dampers - Open/Max
- OA Dampers - Closed; Return Damper - Open
- Heat - All heat stages off; Mod Heat output Off
- Occupied/Unoccupied/VAV box output - Energized
- VOM Relay - Energized

### **EMERG\_PURGE:**

- Supply Fan VFD - Max
- Relief Fan - On; Relief Dampers Open
- OA Dampers - Open; Return Damper - Closed
- Heat - All heat stages off; Mod Heat output Off
- Occupied/Unoccupied/VAV box output - Energized
- VOM Relay - Energized

### **EMERG\_SHUTDOWN:**

- Supply Fan VFD - Min
- Relief Fan - Off; Relief Dampers Closed (if so equipped)
- OA Dampers - Closed; Return Damper - Open
- Heat - All heat stages off; Mod Heat output Off
- Occupied/Unoccupied/VAV box output - Energized
- VOM Relay - Energized

### **EMERG\_FIRE - Input from fire pull box/system:**

- Supply Fan - Off
- Supply Fan VFD - Min
- Relief Fan - Off; Relief Dampers Closed (if so equipped)

- OA Dampers - Closed; Return Damper - Open
- Heat - All heat stages off; Mod Heat output Off
- Occupied/Unoccupied/VAV box output - Energized
- VOM Relay - Energized

## Ventilation Override (VOM)

The user can customize up to five different override sequences for purposes of ventilation override control. If more than one VOM sequence is being requested, the sequence with the highest priority is initiated first. Sequence hierarchy is the sequence "A" (UNIT OFF) is first, with sequence "E" (PURGE with Duct Pressure Control) last. A ventilation override mode can be initiated by closing any of the five corresponding binary inputs on the VOM module. A binary output is provided on the VOM module to provide remote indication of an active VOM mode. All compressors, condenser fans and the Humidification output are de-energized for any VOM sequence. The factory default definitions for each mode are as follows:

### UNIT OFF sequence "A"

When complete system shutdown is required the following sequence can be used.

- Supply Fan VFD - Min
- Relief Fan - Off; Relief Dampers - Closed (if so equipped)
- OA Dampers - Closed; Return Damper - Open
- Heat - All heat stages off; Mod Heat output Off
- Occupied/Unoccupied/VAV box output - Deenergized
- VOM Relay - Energized

### PRESSURIZE sequence "B"

Perhaps a positively pressurized space is desired instead of a negatively pressurized space. In this case, the supply fan should be turned on with VFD at 100% speed and relief fan should be turned off.

- Supply Fan - On
- Supply Fan VFD - Max
- Relief Fan - Off; Relief Dampers - Closed (if so equipped)
- OA Dampers - Open; Return Damper - Closed
- Heat - All heat stages off; Mod Heat output Off
- Occupied/Unoccupied/VAV box output - Energized
- VOM Relay - Energized

### RELIEF sequence "C"

With only the relief fans running (supply fan off), the space that is conditioned by the rooftop would become negatively pressurized. This is desirable for clearing the area of smoke from the now-extinguished fire, possibly keeping smoke out of areas that were not damaged.

- Supply Fan VFD - Min
- Relief Fan - On; Relief Dampers Open (if so equipped)
- OA Dampers - Closed; Return Damper - Open
- Heat - All heat stages off; Mod Heat output Off
- Occupied/Unoccupied/VAV box output - Deenergized
- VOM Relay - Energized

### PURGE sequence "D"

Possibly this sequence could be used for purging the air out of a building before coming out of Unoccupied mode of operation on VAV units or for the purging of smoke or stale air if required after a fire.

- Supply Fan VFD - Max
- Relief Fan - On; Relief Dampers Open (if so equipped)
- OA Dampers - Open; Return Damper - Closed
- Heat - All heat stages off; Mod Heat output Off
- Occupied/Unoccupied/VAV box output - Energized
- VOM Relay - Energized



### **PURGE with duct pressure control sequence “E”**

This sequence can be used when supply air control is required for smoke control.

- Supply Fan VFD - (If so equipped) Controlled by Supply Air Pressure Control function; Supply Air Pressure High Limit disabled
- Relief Fan - On; Relief Dampers Open (if so equipped)
- Heat - All heat stages off; Mod Heat output Off
- Occupied/Unoccupied/VAV box output - Energized
- VOM Relay - Energized

## **User Interface (UI)**

A 7 inch user interface features a touch-sensitive color screen that provides operating status, performance monitoring, and scheduling changes and operating adjustments.

## **Demand Limit**

This mode is used to reduce electrical consumption at peak load times. When demand limiting is needed, mechanical cooling and/or heating operation are either partially or completely disabled in order to save energy.

## **Frost Avoidance**

### **Evaporator Coil Frost Protection - Frostat™**

Temperature and pressure sensors on each refrigeration circuit are used to determine if the coil is approaching a freezing condition. Mechanical cooling capacity is shed as necessary to prevent icing. The Frostat™ system eliminates the need for hot gas bypass and utilizes the suction line surface temperature sensor to shed cooling when coil frosting conditions occur. The supply fans are not shut off and will de-ice the coil. Timers prevent the compressors from rapid cycling.

## **Occupied/Unoccupied Switching**

There are two ways to switch Occupied/Unoccupied:

- Field-supplied contact closure (hard wired binary input to Symbio™ 800 Controls) (CV, SZVAV and VAV) This input accepts a field supplied switch or contacts closure such as a time clock.
- Tracer (or third party BAS with BACnet® or LON option)

## **Trane Tracer® Ensemble™ or BAS System**

The Tracer® Ensemble™ building management system or a third party BAS (with BACnet® or LON option) can control the Occupied/Unoccupied status of the rooftop.

### **Timed Override Activation - ICS**

This function is operational when the Zone Temperature Sensor is installed. When this function is initiated by the push of an override button on the ICS sensor, the Tracer Ensemble will switch the unit to the Occupied mode. Unit operation (Occupied mode) during timed override is terminated by a signal from Tracer.

### **Timed Override Activation - Non-ICS**

This function is active whenever the Zone Temperature Sensor is installed. When this function is initiated by the push of an override button on the zone sensor, the unit will switch to the Occupied mode. Automatic Cancellation of the Timed Override Mode occurs after three hours of operation.

## **Economizer Controls**

### **Comparative Enthalpy Control of Economizer**

An optional comparative enthalpy system is used to control the operation of the economizer, and measures the temperature and humidity of both return air and outside air to determine which

source has lower enthalpy. This system allows true comparison of outdoor air and return air enthalpy by measurement of outdoor air and return air temperatures and humidities.

### **Reference Enthalpy Control of Economizer**

The optional reference enthalpy compares outdoor air temperature and humidity to the economizer enthalpy control setpoint. If outdoor air temperature and humidity are below the economizer enthalpy control setpoint, the economizer will operate freely. This system provides more sophisticated control where outdoor air humidity levels may not be acceptable for building comfort and indoor air quality.

### **Dry Bulb Temperature Control of Economizer**

The optional dry bulb system measures outdoor temperature comparing it to the economizer control temperature setpoint. If the outdoor temperature is below the economizer dry bulb temperature control setpoint, the economizer will operate freely. This system is best suited for arid regions where the humidity levels of outside air would not be detrimental to building comfort and indoor air quality.

## **Refrigeration Balanced Starts**

Balanced starts is a user-selectable feature through the User Interface available on all units without the eFlex™ variable speed option. After each request for compressor operation, the lead refrigeration circuit switches, thereby causing a more equitable or balanced run time among compressors.

## **Emergency Stop Input**

A binary input is provided for installation of field provided switch or contacts for immediate shutdown of all unit functions.

## **Anti-Short Cycle Protection**

A standard feature provided to prevent excessive cycling and premature wear of the compressors, contactors and related components.

## **High Duct Temperature Limit**

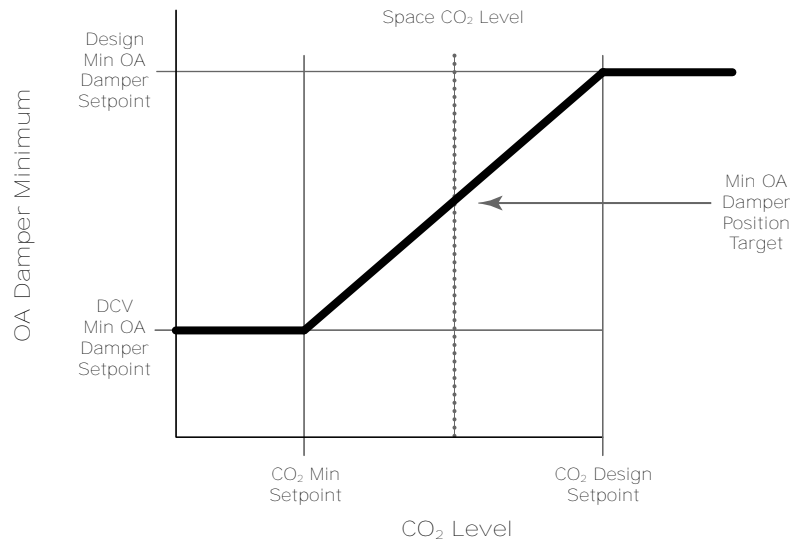
Two temperature sensors, Discharge Air and Return Air (if installed) are used to determine if duct temperatures are excessively high. If the discharge air temperature exceeds 200F or if the return air temperature exceeds 135F, the unit will be placed into Emergency Stop Mode.

## **CO<sub>2</sub> Control - Demand Control Ventilation (DCV)**

A ventilation reset function that provides the necessary ventilation for occupants and reduces energy consumption by minimizing the outdoor air damper position (or the OA flow setpoint with Traq) below the Building Design Minimum, while still meeting the ASHRAE Std 62.1-2004 ventilation requirements.

- If the space CO<sub>2</sub> level is greater than or equal to the CO<sub>2</sub> Design Setpoint, the outdoor air damper will open to the Design Min Outdoor Air Damper (or OA Flow) Setpoint. If there is a call for economizer cooling, the outdoor air damper may be opened further to satisfy the cooling request.
- If the space CO<sub>2</sub> level is less than or equal to the CO<sub>2</sub> Minimum Setpoint, the outdoor air damper will close to the DCV Minimum Outdoor Air Damper (or OA Flow) Setpoint. If there is a call for economizer cooling, the outdoor air damper may be opened further to satisfy the cooling request.
- If the space CO<sub>2</sub> level is greater than the CO<sub>2</sub> Minimum Setpoint and less than the CO<sub>2</sub> Design Setpoint, the outdoor air damper position is (or OA flow) modulated proportionally to the Space CO<sub>2</sub> level relative to a point between the CO<sub>2</sub> Min Setpoint and the CO<sub>2</sub> Design Setpoint. If there is a call for economizer cooling, the outdoor air damper may be opened further to satisfy the cooling request.

**Note:** CO<sub>2</sub> sensor used with Demand Control Ventilation must be powered from an external power source or separate 24 VAC transformer.

**Figure 9. CO<sub>2</sub> control**


## Low Charge Protection

A refrigerant charge estimate is calculated using a combination of measured temperatures, calculated saturated temperatures, refrigerant mass flow and the expansion valve opening. At the touch screen interface, a warning diagnostic is displayed when a low charge has been detected on the circuit, but is not critical enough to force a circuit shutdown. When a critical low charge has been detected on the circuit, a circuit shut down is triggered, and a shutdown diagnostic is displayed at the touch screen interface. Other diagnostic messages include the following:

- A diagnostic message displayed at the User Interface panel, warning of a low charge situation when the unit is just slightly undercharged. The unit will be allowed to run.
- A diagnostic message displayed at the User Interface panel, warning of a low charge situation when the unit is undercharged. The undercharged circuit will be locked out to protect the compressors.

## Condenser Fan Cycling

The Symbio™ 800 controller cycles condenser fans based on ambient temperature and saturated condensing temperature to ensure the optimum operating conditions for the unit.

## LonTalk® Building Automation System

The LonTalk® communication protocol for the Symbio™ 800 controller expands communications from the unit UCM network to a Tracer® Ensemble™ building automation system or third party building automation system. Utilizing LonTalk®, the BAS allows external setpoint and configuration adjustment and monitoring of status and diagnostics. The Symbio™ 800 utilizes an FTT-10A free topology transceiver, which supports non-polarity sensitive, free topology wiring—which in turn allows the system installer to utilize star, bus, and loop architectures. This controller works in standalone mode, peer-to-peer with one or more other units, or when connected to a Tracer® Ensemble™, Tracer SC+, or a third party building automation system that supports LonTalk®. The LON controller is available as a factory or field-installed kit.

## BACnet® Building Automation Control Network

The BACnet® control network for Symbio™ 800 expands communications from the unit UCM network to the Tracer® Ensemble™ or Tracer SC+ building automation system or third party building automation system. Utilizing BACnet, the BAS allows external setpoint and configuration adjustment and monitoring of status and diagnostics. The Symbio 800 utilizes the BACnet defined MS/TP protocol as defined in ASHRAE standard 135-2004. This controller works



in standalone mode, with Tracer® Ensemble™, Tracer SC+ or when connected to a third party building automation system that supports BACnet.

## AirFi™ Wireless Communication Interface

Trane AirFi™ Wireless Comm replaces the BACnet communication link and sensor wire on Tracer® building automation systems for faster, easier, lower-risk installation and life-cycle savings.

## Modulating Hot Gas Reheat

When space conditions allow, the modulating hot gas reheat function activates the reheat mode. The reheat valve and cooling valve are modulated to control the discharge air temperature to the discharge air temperature reheat setpoint (default 70 °F).

In reheat mode, the reheat valve is commanded (15 to 85%) to control to the discharge air reheat setpoint and the cooling valve mirrors the reheat valve position (85 to 15%).

## Low Ambient Compressor Lockout

This function will lock out the compressor if the outdoor air temperature is below the low ambient compressor lock out temperature setpoint. The factory setpoint is 50°F on standard units and 0°F on low ambient units. This setpoint is adjustable at the User Interface. Compressors will be locked out when outdoor air temperatures fall below the selected temperature and will be allowed to start again when temperatures rise 5°F above the setpoint.

## Specifications

Controller Specifications	
Input power	24 Vdc +/- 10%, 400mA max
Storage temperature	-67°F to 185°F (-55°C to 85°C), Humidity: Between 5% to 100% (Condensing)
Operating temperature	-40°F to 158°F (-40°C to 70°C)
Environmental rating (enclosure)	IP3x
Time clock	On-board real time clock with 10 year battery backup
Mounting weight	Mounting surface must support 1.3 lb. (0.6 kg)
Overall dimensions	5.65 in. (143.5 mm) wide x 4.00 in. (101.6 mm) high x 2.17 in. (55 mm) deep
Agency Compliance	
<ul style="list-style-type: none"> <li>• UL916 PAZX, Open Energy Management Equipment</li> <li>• UL94-5V Flammability</li> <li>• CE</li> <li>• FCC Part 15, Subpart B, Class B Limit</li> <li>• BTL Listed—Advanced Application Profile (B-AAC)</li> </ul>	
User Interface Specifications	
Input power	24 Vac +/- 10%, 21 VA, 50, or 60 Hz
Storage temperature	-67°F to 203°F (-55°C to 95°C), Humidity: Between 5% to 100% (Condensing)
Operating temperature	-40°F to 158°F (-40°C to 70°C), Humidity: Between 5% to 100% (Condensing)
Environmental rating (enclosure)	IP56 (dust and strong water jet protected) with optional sealed Ethernet cable (PN: X19070632020)
Mounting weight	Mounting surface must support 1.6 lb. (0.74 kg)
Overall dimensions	8.3 in. (211.6 mm) wide x 6.3 in. (158.8 mm) high x 2.1 in. (53.2 mm) deep [bezel depth 0.4 in. (11.3 mm)]



## Symbio™ 800 Controls

---

### Agency Compliance

- UL916 PAZX, Open Energy Management Equipment
- UL94-5V, Flammability
- FCC CFR Title 47, Part 15.109: Class A Limit, (30 MHz—4 GHz)
- CE EMC Directive 2004/108/EC



# Application Considerations

## Clearance Requirements

The recommended clearances identified in unit dimensions should be maintained to assure adequate service capability, maximum capacity and peak operating efficiency. A reduction in unit clearance could result in condenser coil starvation or warm condenser air recirculation. If the clearances shown are not possible on a particular job, consider the following:

- Do the clearances available allow for major service work such as changing compressors or coils?
- Do the clearances available allow for proper outside air intake, relief air removal and condenser airflow?
- If screening around the unit is being used, is there a possibility of air recirculation from the relief to the outside air intake or from condenser exhaust to condenser intake?
- Do clearances meet all applicable codes?

Actual clearances which appear inadequate should be reviewed with a local Trane sales engineer.

When two or more units are to be placed side by side, the distance between the units should be increased to 150 percent of the recommended single unit clearance. The units should also be staggered for the following reasons:

- To reduce span deflection if more than one unit is placed on a single span. Reducing deflection discourages sound transmission.
- To assure proper diffusion of exhaust air before contact with the outside air intake of adjacent unit.

## Modulating Hot Gas Reheat for Dehumidification

Modulating hot gas reheat involves adding a refrigerant-to-air heat exchanger downstream of the evaporator (cooling) coil. A valve diverts the hot refrigerant vapor leaving the compressor through this heat exchanger to reheat the dehumidified air leaving the evaporator coil. This allows the use of heat that is recovered from the refrigeration circuit of the rooftop unit to reduce system operating costs by avoiding the use of “new” energy for reheat.

The main function of the IntelliPak® rooftop unit is to provide zone temperature control. While modulating hot gas reheat will improve dehumidification performance at part-load conditions, it does not function as a standalone dehumidifier. In general, hot gas reheat requires a call for cooling to initiate. If there is a need for dehumidification when there is no need for sensible cooling, another solution may need to be investigated. IntelliPak packaged rooftop systems include non-standard solutions that might be considered for these applications.

Applications which should be investigated before using the standard modulating hot gas reheat option include:

- Process humidity control applications
- Makeup air or 100% outdoor air
- Zones with dramatically varying load conditions (sanctuaries, locker rooms, gymnasiums, etc.)

## Ventilation Control

Ventilation is the process of delivering clean, fresh outdoor air into the building to dilute the build-up of contaminants and odors. ASHRAE Standard 62.1 defines the minimum ventilation rates and basic HVAC equipment and system requirements to provide “acceptable indoor air quality.” Units with a variable-speed supply fan should either be equipped with the Traq™ outdoor air measurement system or use the “Outdoor Air Compensation” control sequence to ensure proper ventilation at all operating conditions:

- The Traq™ outdoor air measurement system uses velocity pressure sensing rings to measure airflow in the outdoor air intake. This allows the outdoor airflow to be controlled to a desired setpoint, compensating for changing conditions.
- The Outdoor Air CFM Compensation sequence automatically adjusts the position of the OA dampers in proportion to the changing supply fan speed. This attempts to maintain the same CFM of outdoor airflow entering the unit, even as the supply fan speed changes.

**Demand-controlled ventilation (DCV)** is a control strategy that dynamically adjusts the outdoor airflow delivered to a zone based on the changing population in that zone, often by measuring the concentration of carbon dioxide (CO<sub>2</sub>) in the zone. Zones that are densely-occupied and experience widely varying population—such as large conference rooms, auditoriums, and gymnasiums—are often good candidates for using CO<sub>2</sub>-based DCV.

## Ventilation Override Sequences

One of the benefits of using a relief fan rather than a return fan, in addition to the benefits of lower energy usage is that the rooftop can be used as part of a ventilation override system. Several types of sequences can be easily done when relief fans are a part of the rooftop system.

What would initiate the ventilation override control sequence? Typically, a manual switch is used and located near the fire protection control panel. This enables the fire department access to the control for use during or after a fire. It is also possible to initiate the sequence from a field-installed automatic smoke detector. In either case, a contact closure begins the ventilation override control sequence.

Trane can provide five (5) different ventilation override sequences on both CV and VAV IntelliPak® rooftops. For convenience, the sequences are factory preset but are fully field edited from the user interface or Tracer TU. Any or all five sequences may be “locked” in by the user at the user interface.

The user can customize up to five (5) different override sequences for purposes such as smoke control. The following parameters within the unit can be defined for each of the five sequences:

- Supply Fan - on/off
- Variable Frequency Drives - on (60 Hz)/off (0 Hz)/controlling
- Relief Fan - on/off
- Relief Air Dampers - open/closed
- Outdoor Air Dampers - open/closed
- Heat - off/controlling (output for) VAV Boxes - open/controlling

Compressors and condenser fans are shut down for any Ventilation Override sequence. Factory preset sequences include unit Off, Exhaust, Purge, Purge with duct pressure control, and Pressurization. Any of the user-defined Ventilation Override sequences can be initiated by closing a field supplied switch or contacts connected to an input on the Ventilation Override Module. If more than one ventilation override sequence is being requested, the sequence with the highest priority is initiated. Refer to the Ventilation Override Mode (VOM) information in the Control section of this catalog for more details on each override sequence.

## Relief Fan Options

When the rooftop unit brings in outdoor air for ventilation, the same quantity of air must leave the building. Typically, some of this air is exhausted by dedicated fans from restrooms or other spaces. Some air also leaks out through the building envelope as a result of the pressure inside the building being maintained slightly higher than the pressure outside the building (“positive” building pressurization).

Particularly when the rooftop unit is equipped with an airside economizer, a properly-designed relief system should be used to avoid over-pressurizing the building when the outdoor-air dampers open to bring in a larger quantity of air from outside. A relief fan is often included in the rooftop unit to help control building pressure. The Trane modulating relief fan (with Statitrac™) is an excellent choice for controlling building pressure in the majority of applications.

In a unit with a relief fan, the supply fan motor and drives must be sized to create a high enough pressure at the supply fan outlet to overcome the pressure losses associated with the supply-air

path, and also create a low enough pressure at the supply fan inlet to overcome the pressure losses associated with the return-air path and components inside the rooftop unit.

## Barometric Relief Dampers

This approach uses non-motorized, gravity-operated relief dampers that are located in the return-air section of the rooftop unit. When the building pressure increases, the pressure inside the return-air section also increases, eventually forcing open the relief dampers and allowing air to leave the building.

Barometric relief dampers are typically used in small buildings that use an open ceiling plenum for the return-air path. They are relatively inexpensive and require no sensors or controls, but they may require the building pressure to increase significantly before relieving sufficient airflow.

## Modulating Relief Fan with Statitrac™

This approach uses a powered relief fan located inside the return-air section of the rooftop unit. The fan is sized to relieve up to 100 percent of the nominal supply fan airflow, and its capacity is modulated to maintain measured building pressure at a desired setpoint.

The Trane Statitrac™ control system uses a differential pressure transducer to compare indoor (building) static pressure to atmospheric (outdoor) static pressure. The relief fan is turned on whenever needed to relieve air, then modulates the speed of the relief fan (or modulates the position of discharge dampers) to control the building pressure within the adjustable deadband, which can be set at the user interface.

The Trane modulating relief fan with Statitrac provides efficient control of building pressure in both constant-volume and VAV applications. The relief fan operates only when needed to lower building pressure, meaning that in some buildings it may only need to operate when the unit is airside economizing. By directly measuring building pressure, the modulating relief fan can respond to pressure changes caused by wind, stack effect, the intermittent operation of local relief fans, and demand-controlled ventilation.

## Modulating Relief Fan without Statitrac (CV Units Only)

The difference with this approach is that a transducer is not used to directly measure building pressure. The relief fan is turned on whenever the outdoor air dampers are open beyond a set position. The relief fan operates at a constant speed and the relief fan discharge dampers are modulated in proportion to the position of the outdoor-air dampers; as the outside air dampers open further, the discharge dampers on the relief fan open further to allow for more relief air. When the relief fan starts, the discharge dampers are fully closed, resulting in relief airflow equal to about 15% to 20% of relief fan capacity.

## Acoustic Considerations

The best time to make provisions to reduce sound transmission to the occupied space is during the project design phase. Proper placement of rooftop equipment is critical to reducing sound transmitted into the building. The most economical means of avoiding an acoustical problem is to locate rooftop equipment away from acoustically-sensitive areas. If possible, locate rooftop equipment above corridors, utility rooms, restrooms, or other areas where higher sound levels are acceptable.

It is not possible to totally quantify the effect of the building structure on sound transmission, since this depends on the response of the roof and building members to the sound and vibration of the unit components. However, the following guidelines have been proven through experience to help reduce sound transmission through the building structure:

- Never cantilever the condensing section of the rooftop unit; a structural cross member must support this end of the unit.
- Locate the unit's center of gravity close to (or over) a column or main support beam to minimize roof deflection and vibration-related noise.
- If the roof structure is very light, roof joists should be replaced by a structural shape in the critical areas described above.



## Application Considerations

---

- If several units are to be placed on one span, they should be staggered to reduce deflection over that span.

For more information:

- ASHRAE. 2015. *ASHRAE Handbook – HVAC Applications* (Chapter 48: Noise and Vibration Control). Atlanta, GA: ASHRAE.
- ASHRAE. 2011. *Practical Guide to Noise and Vibration Control for HVAC Systems*. Atlanta, GA: ASHRAE.
- Guckelberger, D. 2000. "Controlling Noise From Large Rooftop Units," *ASHRAE Journal* (May): pp. 55-62.
- Trane. Guckelberger, D. and Bradley, B. 2006. *Acoustics in Air Conditioning*, ISS-APM001-EN. La Crosse, WI: Inland Printing Company.
- Trane. Murphy, J. and Harshaw, J. 2012. *Rooftop VAV Systems*, SYS-APM007-EN. La Crosse, WI: Inland Printing Company.

In addition, the Trane TAP™ Acoustics Program allows for modeling of various sound paths to predict sound levels in the occupied space. The software models airborne sound from supply- and return-air paths, as well as duct breakout and roof transmission sound, so that the designer can identify potential sound problems and make design alterations before equipment installation. TAP is also capable of modeling the effect of outdoor sound on adjacent properties. This program is available from Trane's Customer Direct Service Network (C.D.S.), ask your local Trane representative for additional information.

## Corrosive Atmospheres

Trane's IntelliPak® Rooftops are designed and built to industrial standards and will perform to those standards for an extended period depending on the hours of use, the quality of maintenance performed, and the regularity of that maintenance.

One factor that can have an adverse effect on unit life is operation in a corrosive environment. Since the Microchannel condenser coil is an all-aluminum design, it provides a high level of corrosion protection on its own. Uncoated, it withstands a salt spray test in accordance with ASTM B117 for 1,000 hours. When rooftops are operated in highly corrosive environments, Trane recommends the corrosion protected condenser coil option.

This corrosion protection option meets the most stringent testing in the industry, including ASTM B117 Salt Spray test for 6,000 hours and ASTM G85 A2 Cyclic Acidified Salt Fog test for 2,400 hours. The acid fog test is the most stringent available today. This coating is added after coil construction covering all tubes, headers, fins and edges. The design provides superior protection from any corrosive agent.

IntelliPak paint innately handles harsh weather, including most coastal and salt environments and direct sun. The unit paint was salt spray tested in accordance with ASTM B117 and UV weathering resistance tested in accordance with ASTM G155 Test cycle 1 for 2000 hours. For further detail on the paint testing, refer to PROD-SLB034\*-EN

**Note:** Field coating is not allowed on Microchannel coils.

## Natural Gas Heating Considerations

Trane offers heavy gauge 409 stainless steel throughout the construction of ETL recognized, natural gas tubular exchangers. These heat exchangers can be applied with confidence, particularly with full modulation control, when mixed air temperatures are below 50°F, and low ambient temperatures can cause condensation to form on the heat exchanger. The IntelliPak® natural gas heat exchangers are not recommended for applications with mixed air conditions entering the heat exchanger below 30°F to ensure adequate leaving air heating temperature.

## **High Entering Return Temperatures**

Some applications may have high mixed-air temperatures, such as data centers. It is recommended that the entering dry bulb temperatures in any application not exceed 95°F for extended periods of time. If this is a requirement, please work with your local Trane office in developing a specific assessment. Other factors, such as wet bulb and ambient temperatures, will also affect the system's reaction.



# Performance Data

## Performance Adjustment Factors

Table 7. Enthalpy of saturated air

Wet Bulb Temperature	Btu Per Lb.
40	15.23
41	15.70
42	16.17
43	16.66
44	17.15
45	17.65
46	18.16
47	18.68
48	19.21
49	19.75
50	20.30
51	20.86
52	21.44
53	22.02
54	22.62
55	23.22
56	23.84
57	24.48
58	25.12
59	25.78
60	26.46
61	27.15
62	27.85
63	28.57
64	29.31
65	30.06
66	30.83
67	31.62
68	32.42
69	33.25
70	34.09
71	34.95
72	35.83
73	36.74
74	37.66
75	38.61



Figure 10. Air density ratios

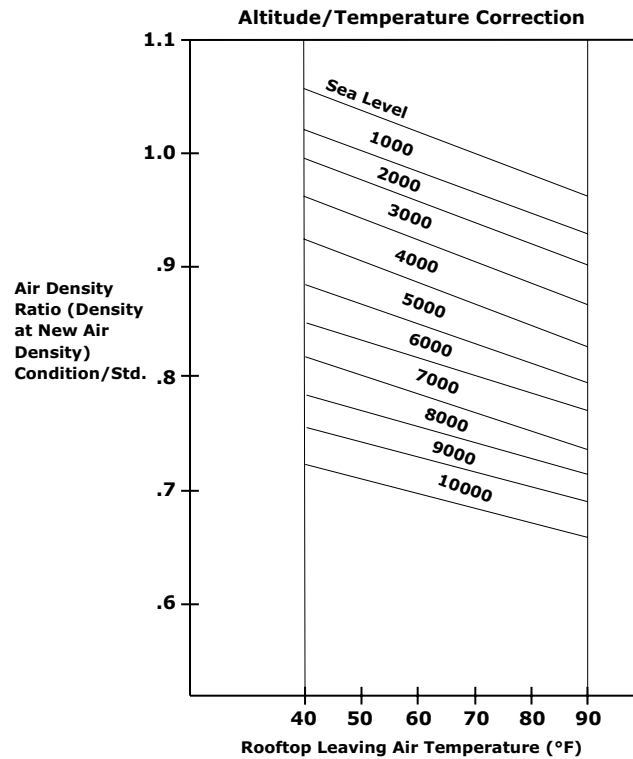


Table 8. Cooling capacity altitude correction factors

	Altitude (ft)								
	Sea Level	1000	2000	3000	4000	5000	6000	7000	8000
Cooling Capacity Multiplier	1.00	1.00	0.99	0.99	0.99	0.98	0.98	0.97	0.97
kW Correction Multiplier	1.00	1.00	1.00	1.00	1.01	1.01	1.01	1.02	1.02
Sensible Heat Ratio Correction Multiplier	1.00	0.97	0.94	0.92	0.89	0.87	0.84	0.81	0.79

Table 9. Gas heating capacity altitude correction factors

	Sea Level to 2000	2001 to 2500	2501 to 3500	3501 to 4500	4501 to 5500	5501 to 6500	6501 to 7500
Capacity Multiplier	1.00	.92	.88	.84	.80	.76	.72



# Gross Cooling Capacities

Table 10. Gross cooling capacities - 20 ton - standard efficiency

CFM	Ent DB (°F)	Ambient Temperature (°F)																							
		85				95				105				115											
		Entering Wet Bulb (°F)		61		67		73		Entering Wet Bulb (°F)		61		67		73		Entering Wet Bulb (°F)		61		67		73	
4000	75	207	144	234	119	264	92	196	137	222	112	251	85	184	129	210	104	237	78	172	122	196	97	222	70
	80	207	166	235	141	264	115	196	159	223	134	251	108	185	151	210	127	237	100	173	144	197	119	222	93
	85	208	188	235	163	264	137	197	181	223	156	251	130	185	173	210	149	237	123	173	165	197	141	223	115
	90	209	208	235	185	264	159	198	198	224	178	251	152	187	187	211	171	238	145	177	177	198	163	223	137
5000	75	223	163	251	131	280	96	210	155	238	123	265	89	197	148	223	116	250	81	184	140	208	107	233	73
	80	224	191	252	159	280	124	211	183	238	151	265	117	198	175	224	143	250	109	185	167	209	135	233	101
	85	225	217	252	186	280	152	213	209	239	179	266	145	200	200	225	171	250	137	187	187	210	163	234	129
	90	231	231	253	214	281	180	221	221	240	206	266	172	210	210	225	198	251	165	198	198	211	189	234	156
6000	75	235	181	263	142	290	99	221	173	248	134	274	91	207	164	233	125	257	83	192	156	216	117	239	75
	80	236	212	264	175	290	133	222	204	249	167	274	125	208	195	234	159	258	117	193	187	217	150	240	108
	85	239	239	264	208	291	166	226	226	250	200	275	158	214	214	234	192	258	150	201	201	218	183	240	141
	90	252	252	265	241	291	199	240	240	251	231	275	191	227	227	236	222	259	183	214	214	220	214	241	174
7000	75	243	198	271	152	296	101	229	189	256	143	280	93	213	180	239	135	262	85	197	169	221	126	243	76
	80	245	234	272	190	297	140	231	225	256	182	280	132	216	216	240	173	263	124	200	200	222	164	243	115
	85	253	253	273	229	297	179	241	241	257	220	281	171	227	227	241	209	263	163	213	213	224	200	244	154
	90	268	268	275	264	298	217	255	255	260	256	281	209	241	241	244	244	263	201	226	226	227	227	244	192
8000	75	250	214	277	161	301	103	234	203	261	152	284	95	218	193	243	143	265	87	202	184	225	134	245	78
	80	253	253	278	205	302	148	238	238	262	196	284	139	223	223	244	187	265	131	209	209	226	178	245	122
	85	266	266	279	246	302	192	252	252	263	237	284	183	238	238	246	228	266	175	222	222	228	218	245	166
	90	280	280	282	282	302	236	266	266	266	266	284	227	251	251	250	250	266	219	235	235	235	235	246	206
9000	75	255	227	282	170	305	105	239	218	265	161	287	97	222	208	246	152	267	88	205	198	227	142	247	79
	80	260	260	283	219	305	155	246	246	265	210	286	147	231	231	247	198	267	138	215	215	228	188	246	128
	85	276	276	284	265	306	205	261	261	267	256	286	196	246	246	250	246	267	187	229	229	231	231	246	178
	90	290	290	289	289	307	251	274	274	274	275	288	242	258	258	258	258	267	232	240	240	240	240	246	222

**Notes:**

1. All capacities shown are gross and have not considered indoor fan heat. To obtain net cooling subtract indoor fan heat
2. CAP = Total Gross Capacity, SHC = Sensible Heat Capacity

**Table 11. Gross cooling capacities — 20 ton — high efficiency and high capacity (60 Hz)**

CFM	Ent DB (°F)	Ambient Temperature (°F)																							
		85				95				105				115											
		Entering Wet Bulb (°F)		Entering Wet Bulb (°F)		Entering Wet Bulb (°F)		Entering Wet Bulb (°F)		Entering Wet Bulb (°F)		Entering Wet Bulb (°F)		Entering Wet Bulb (°F)		Entering Wet Bulb (°F)									
61	73	61	73	61	73	61	73	61	73	61	73	61	73	61	73	61	73								
4000	75	234	158	264	133	297	106	222	150	251	125	283	98	208	141	236	116	266	90	195	133	221	108	249	81
	80	234	180	265	155	297	128	222	172	251	147	283	121	209	163	237	139	267	112	195	155	221	130	249	103
	85	234	202	265	177	297	151	222	194	252	169	283	143	210	185	237	161	267	134	195	177	222	152	249	125
	90	235	224	265	199	298	173	223	215	252	191	283	165	210	207	237	183	267	156	197	197	222	174	250	147
5000	75	254	178	285	146	317	111	240	170	270	137	301	102	224	160	253	128	282	93	208	151	235	119	263	84
	80	254	206	286	174	317	139	240	197	271	165	301	130	225	188	254	156	283	121	209	178	236	146	263	112
	85	255	233	286	201	318	166	241	225	271	193	301	158	226	214	254	183	283	149	210	205	237	174	264	140
	90	257	257	287	229	318	194	245	245	272	220	302	186	233	233	255	211	284	177	219	219	237	201	264	167
6000	75	268	197	300	157	330	114	253	187	283	148	312	105	236	178	265	138	293	96	218	168	245	128	271	86
	80	269	230	300	190	330	147	254	220	284	181	313	139	237	211	265	171	293	129	219	199	246	161	272	120
	85	271	262	301	223	331	181	256	252	284	214	313	172	240	240	266	204	294	163	224	224	246	194	272	153
	90	280	280	301	256	331	214	267	267	285	247	314	205	253	253	267	238	294	196	238	238	248	226	273	186
7000	75	279	214	310	167	339	116	262	204	292	158	320	107	244	194	272	148	299	98	225	183	251	137	277	88
	80	280	252	310	205	339	155	264	241	293	196	321	146	246	231	273	186	300	137	227	220	252	176	277	127
	85	284	284	311	244	339	194	270	270	294	235	321	185	255	255	274	225	300	176	238	238	253	214	278	165
	90	299	299	312	281	340	232	285	285	295	272	321	224	269	269	276	261	301	214	252	252	256	251	278	204
8000	75	287	230	317	176	345	118	269	220	299	167	326	109	250	210	278	156	304	100	230	197	256	146	280	90
	80	289	273	318	220	345	163	272	263	299	211	326	154	253	252	279	200	304	144	234	234	257	190	281	134
	85	299	299	319	264	346	207	284	284	301	255	326	198	267	267	280	243	305	188	249	249	258	231	281	178
	90	314	314	321	306	346	251	299	299	303	296	327	242	282	282	283	283	305	232	263	263	264	264	282	222
9000	75	293	246	323	185	350	120	275	234	303	175	330	111	255	223	282	165	307	102	234	211	259	154	283	91
	80	297	294	324	235	350	170	279	279	304	225	330	161	261	261	283	214	308	151	242	242	260	203	283	141
	85	311	311	325	282	350	220	295	295	306	272	330	211	277	277	285	261	308	201	257	257	262	250	283	190
	90	326	326	328	328	350	269	310	310	310	310	330	260	292	292	292	292	292	308	250	271	271	272	272	284

**Notes:**

1. All capacities shown are gross and have not considered indoor fan heat. To obtain net cooling subtract indoor fan heat
2. CAP = Total Gross Capacity, SHC = Sensible Heat Capacity

**Table 12. Gross cooling capacities — 20 ton eFlex™ variable speed — high capacity (60 Hz)**

CFM	Ent DB (°F)	Ambient Temperature (°F)																							
		85				95				105				115											
		Entering Wet Bulb (°F)		73		Entering Wet Bulb (°F)		67		73		Entering Wet Bulb (°F)		67		73									
		61	SHC	CAP	SHC	61	SHC	CAP	SHC	61	SHC	CAP	SHC	61	SHC	CAP	SHC	61	SHC	CAP	SHC				
4000	75	224	153	253	127	284	101	212	145	240	120	271	93	200	137	227	112	256	86	188	130	213	104	241	78
	80	224	175	253	150	284	123	212	167	241	142	271	116	200	159	227	134	256	108	188	152	214	126	241	100
	85	224	196	253	172	284	145	213	189	241	164	271	138	201	181	228	156	256	130	188	173	214	149	241	122
	90	225	218	254	194	285	167	214	210	241	186	271	160	202	202	228	178	257	152	190	190	214	170	241	144
	75	242	172	272	140	302	105	229	164	258	132	287	97	215	156	242	124	270	89	201	147	227	115	253	80
	80	242	200	272	168	302	133	229	192	258	160	287	125	215	183	243	151	271	117	201	175	227	143	253	108
	85	243	226	273	195	302	160	230	218	259	187	287	153	217	210	244	179	271	145	203	201	228	170	254	136
	90	247	247	273	223	303	188	237	237	259	215	288	180	225	225	244	206	272	172	213	213	229	198	254	164
	75	255	190	285	151	313	107	240	182	269	142	297	100	225	173	253	134	279	91	209	164	235	124	260	82
	80	255	223	285	184	313	141	241	215	270	175	297	133	226	205	254	167	280	125	211	195	236	158	261	116
	85	258	255	286	217	314	174	244	244	271	209	298	166	231	231	254	200	280	158	218	218	237	191	261	149
	90	270	270	287	250	314	207	258	258	272	242	298	199	245	245	256	233	281	191	231	231	239	222	262	182
	75	264	207	294	160	320	110	249	198	277	152	303	102	232	189	260	143	285	93	216	180	241	133	265	84
	80	266	244	294	199	320	149	251	235	278	190	304	140	235	226	261	181	285	132	218	216	242	172	265	123
	85	273	273	295	238	321	187	259	259	279	229	304	179	245	245	262	220	286	170	231	231	243	209	266	161
	90	287	287	297	274	321	226	274	274	281	266	304	218	260	260	264	256	286	209	244	244	246	246	266	200
	75	272	224	300	170	325	112	255	214	283	161	308	103	238	203	265	151	289	95	220	193	245	142	268	85
	80	274	266	301	214	325	156	259	257	284	205	308	148	242	242	266	196	289	139	226	226	246	186	268	129
	85	286	286	302	258	325	200	272	272	285	247	308	192	257	257	267	237	289	183	241	241	248	227	268	173
	90	301	301	305	299	326	244	287	287	288	288	308	235	271	271	271	271	289	227	254	254	255	255	268	217
	75	277	238	305	179	329	114	261	228	288	169	311	105	243	218	268	160	291	96	224	207	248	150	270	87
	80	282	282	306	228	329	163	266	266	288	219	311	155	251	251	269	209	291	146	234	234	249	199	269	136
	85	297	297	307	275	329	213	282	282	290	266	310	204	266	266	272	256	291	195	249	249	251	245	269	185
	90	312	312	312	312	330	262	296	296	297	297	311	253	279	279	280	280	291	242	261	261	261	261	270	231

**Notes:**

1. All capacities shown are gross and have not considered indoor fan heat. To obtain net cooling subtract indoor fan heat
2. CAP = Total Gross Capacity, SHC = Sensible Heat Capacity

**Table 13. Gross cooling capacities — 25 ton — standard efficiency (60Hz)**

CFM	Ent DB (°F)	Ambient Temperature (°F)																							
		85				95				105				115											
		Entering Wet Bulb (°F)		73		61		67		73		61		67		73		61		67		73			
5000	75	244	174	275	142	308	109	331	166	231	134	293	101	218	158	246	126	275	92	203	149	230	117	256	82
	80	244	201	275	170	309	137	293	194	261	162	293	129	218	185	246	154	275	120	204	177	230	145	256	110
	85	245	229	276	197	309	164	293	221	262	190	293	156	219	213	247	181	276	147	205	202	231	172	257	138
	90	246	246	276	225	309	192	293	234	262	217	293	184	221	221	247	209	276	175	208	208	231	200	257	166
6250	75	262	198	294	157	327	114	248	189	278	149	309	105	232	180	261	139	289	96	216	171	242	129	267	85
	80	263	232	295	192	328	149	249	224	279	183	310	140	233	214	261	174	289	130	217	205	243	164	267	120
	85	264	264	295	226	328	184	250	250	280	218	310	175	235	235	262	208	290	165	219	219	243	198	268	155
	90	269	269	296	261	328	218	258	258	280	252	310	209	245	245	263	243	290	200	231	231	244	233	268	189
7500	75	276	220	308	171	340	118	260	211	290	161	319	109	242	201	271	151	297	98	225	191	250	141	272	87
	80	277	261	308	212	340	160	261	252	291	203	320	150	244	239	271	193	297	140	226	226	251	182	273	129
	85	280	280	309	253	341	202	265	265	292	244	320	192	249	249	272	234	298	182	234	234	252	224	273	170
	90	293	293	310	294	341	243	279	279	293	285	321	233	264	264	274	272	299	223	247	247	253	253	274	212
8750	75	286	241	317	183	348	121	268	231	298	173	326	111	250	221	277	162	302	100	230	211	255	151	275	89
	80	287	286	318	231	348	170	270	270	299	221	326	160	252	252	278	211	302	149	233	233	256	200	275	137
	85	294	294	319	279	349	219	278	278	300	270	327	208	264	264	279	259	303	197	246	246	257	248	276	186
	90	311	311	321	321	350	267	296	296	302	302	328	257	278	278	282	282	303	246	259	259	260	260	277	234
10000	75	293	261	325	195	353	124	275	251	304	184	330	113	255	240	282	173	304	102	234	225	258	162	276	90
	80	296	296	326	250	354	180	278	278	305	240	331	169	259	259	283	229	305	158	239	239	259	217	277	146
	85	309	309	327	305	355	235	292	292	306	295	332	225	274	274	284	279	305	213	255	255	261	261	277	201
	90	325	325	330	330	356	290	308	308	308	310	332	280	289	289	289	289	306	268	267	267	266	266	277	256
11250	75	299	281	330	206	357	126	280	266	309	195	333	115	259	255	285	184	306	104	237	237	260	172	276	91
	80	304	304	331	268	358	189	285	285	310	257	334	178	266	266	286	246	306	166	247	247	261	234	277	154
	85	320	320	333	325	359	251	302	302	312	312	334	240	283	283	288	288	307	228	261	261	263	263	278	216
	90	337	337	338	338	360	313	318	318	317	317	335	302	297	297	295	295	307	290	273	273	273	273	279	271

**Notes:**

1. All capacities shown are gross and have not considered indoor fan heat. To obtain net cooling subtract indoor fan heat
2. CAP = Total Gross Capacity, SHC = Sensible Heat Capacity

**Table 14. Gross cooling capacities — 25 ton — high efficiency and high capacity (60 Hz)**

CFM	Ent DB (°F)	Ambient Temperature (°F)																							
		85						95						105						115					
		Entering Wet Bulb (°F)			Entering Wet Bulb (°F)			Entering Wet Bulb (°F)			Entering Wet Bulb (°F)			Entering Wet Bulb (°F)			Entering Wet Bulb (°F)			Entering Wet Bulb (°F)					
		61	67	73	61	67	73	61	67	73	61	67	73	61	67	73	61	67	73						
5000	75	275	189	310	157	345	122	260	180	293	148	327	113	244	170	276	138	308	103	228	161	257	128	286	93
	80	275	217	310	185	345	150	261	208	294	176	327	141	245	198	276	166	308	131	228	188	258	156	287	121
	85	276	244	310	213	345	178	261	235	294	203	328	169	245	225	277	193	308	159	229	216	258	183	287	149
6250	90	277	271	311	240	346	206	263	262	295	231	328	197	248	248	277	221	309	187	235	235	259	211	288	176
	75	296	213	330	172	363	126	279	203	312	162	344	117	260	192	292	151	322	106	242	182	271	140	298	96
	80	296	248	331	206	364	161	280	238	313	196	344	152	261	227	293	186	322	141	243	216	271	175	299	130
7500	85	298	281	331	241	364	196	282	271	313	231	345	186	264	260	293	220	323	176	246	246	272	209	299	165
	90	305	305	332	275	364	230	291	291	314	265	345	221	276	276	294	255	323	210	260	260	273	244	300	200
	75	310	235	344	184	374	129	292	224	324	174	353	119	271	213	302	163	330	109	251	202	279	151	305	97
8750	80	312	276	345	226	375	171	293	266	325	215	354	161	273	253	303	204	331	150	253	241	280	193	305	139
	85	315	315	345	267	375	212	298	298	326	257	354	202	281	281	304	246	331	192	263	263	281	234	306	181
	90	330	330	347	308	376	254	315	315	327	298	355	244	297	297	306	285	331	233	278	278	283	273	306	222
10000	75	321	256	353	196	382	131	301	245	332	185	360	121	279	233	309	174	335	111	257	219	285	162	309	99
	80	323	302	354	244	382	180	304	291	333	233	360	170	283	279	310	222	336	159	261	261	285	210	309	147
	85	333	333	355	292	382	228	316	316	334	282	360	218	297	297	311	270	336	207	277	277	287	256	309	196
11250	90	349	349	357	338	383	276	332	332	337	327	361	266	312	312	315	315	336	255	291	291	291	291	310	244
	75	329	276	360	207	387	134	308	264	338	196	364	123	285	250	314	184	339	112	262	237	288	172	311	101
	80	332	328	361	262	387	189	312	312	339	251	364	179	291	291	315	239	339	167	271	271	289	227	311	156
11250	85	347	347	362	315	387	244	329	329	341	303	364	234	308	308	317	291	339	222	286	286	291	278	311	211
	90	364	364	366	366	388	299	345	345	345	345	365	289	324	324	324	324	339	277	300	300	301	301	312	262
	75	335	293	365	218	391	136	313	281	342	206	367	126	290	267	317	194	341	114	265	254	290	182	313	102
11250	80	341	341	366	280	391	198	322	322	343	268	367	187	301	301	318	256	340	176	278	278	291	240	312	164
	85	359	359	368	338	392	260	339	339	345	326	367	249	317	317	321	314	340	238	294	294	295	295	312	226
	90	374	374	375	375	393	323	354	354	355	355	368	308	331	331	332	332	341	295	306	306	307	307	312	282

**Notes:**

1. All capacities shown are gross and have not considered indoor fan heat. To obtain net cooling subtract indoor fan heat
2. CAP = Total Gross Capacity, SHC = Sensible Heat Capacity

**Table 15. Gross cooling capacities — 25 ton eFlex™ variable speed — high capacity (60 Hz)**  
**Ambient Temperature (°F)**

CFM	Ent DB (°F)	85												95												105												115											
		Entering Wet Bulb (°F)						Entering Wet Bulb (°F)						Entering Wet Bulb (°F)						Entering Wet Bulb (°F)						Entering Wet Bulb (°F)						Entering Wet Bulb (°F)																	
		61	67	73	CAP	SHC	SHC	61	67	73	CAP	SHC	SHC	61	67	73	CAP	SHC	SHC	61	67	73	CAP	SHC	SHC	61	67	73	CAP	SHC	SHC																		
5000	75	268	186	303	155	342	122	254	177	288	146	325	113	239	168	271	136	307	104	224	158	254	127	288	94																								
	80	269	214	304	183	342	150	255	205	288	173	325	141	240	195	272	164	307	132	224	186	255	155	288	122																								
	85	270	241	304	210	343	178	256	232	289	201	326	169	241	222	272	192	307	159	226	213	255	182	289	150																								
	90	272	268	305	238	343	205	258	258	289	229	326	196	245	245	273	219	308	187	233	233	256	210	290	178																								
	75	288	210	325	170	364	128	272	200	307	160	345	119	255	190	288	150	324	109	238	180	269	140	303	99																								
	80	289	244	326	205	365	163	273	235	308	195	345	153	256	225	289	185	325	144	239	213	270	175	304	134																								
	85	292	278	326	239	366	198	276	268	309	229	346	188	259	258	290	219	326	178	244	244	271	209	305	168																								
	90	302	302	327	274	366	232	288	288	310	264	347	223	274	274	291	253	327	213	259	259	273	243	306	203																								
	75	303	232	340	183	380	133	285	222	321	173	358	123	266	211	300	163	336	112	247	200	279	152	314	102																								
	80	305	272	341	225	380	175	287	261	322	215	359	165	269	251	301	204	337	154	250	240	281	194	315	144																								
	85	310	310	342	266	381	216	295	295	323	256	361	206	279	279	303	246	339	196	263	263	282	234	317	186																								
	90	328	328	345	306	382	258	313	313	326	296	362	248	297	297	306	285	340	238	280	280	286	274	318	227																								
	75	314	253	351	196	390	137	295	242	330	185	368	126	275	229	308	174	344	115	254	218	286	163	321	105																								
	80	317	299	353	244	392	185	298	288	332	234	369	175	279	277	310	223	346	164	260	260	288	212	323	154																								
	85	330	330	354	291	393	234	314	314	334	280	371	224	296	296	312	269	347	213	279	279	291	258	325	203																								
	90	350	350	358	339	394	282	333	333	338	328	372	272	315	315	317	317	349	262	297	297	298	298	326	251																								
	75	323	271	360	208	398	140	302	260	338	197	375	129	281	248	315	185	350	118	260	236	291	174	326	108																								
	80	328	326	361	263	400	196	309	309	339	252	377	185	290	290	317	241	352	174	272	272	293	227	329	163																								
	85	347	347	364	316	401	251	329	329	343	305	378	241	310	310	320	293	354	230	291	291	297	281	330	219																								
	90	368	368	370	370	403	307	350	350	350	350	380	296	330	330	331	331	356	283	311	311	312	312	333	271																								
	75	330	291	366	220	405	143	309	278	343	208	380	132	287	266	319	196	354	121	265	254	295	185	330	110																								
	80	340	340	368	282	407	206	321	321	346	268	382	195	301	301	322	256	357	184	281	281	298	243	332	173																								
	85	361	361	372	341	408	268	342	342	350	329	384	257	322	322	327	317	359	246	302	302	304	304	334	235																								
	90	383	383	384	384	410	328	364	364	364	364	386	316	343	343	344	344	362	305	323	323	323	323	337	293																								

**Notes:**

1. All capacities shown are gross and have not considered indoor fan heat. To obtain net cooling subtract indoor fan heat
2. CAP = Total Gross Capacity, SHC = Sensible Heat Capacity

Table 16. Gross cooling capacities — 30 ton — standard efficiency (60Hz)

CFM	Ent DB (°F)	Ambient Temperature (°F)																					
		85				95				105				115									
		Entering Wet Bulb (°F)		61		67		73		Entering Wet Bulb (°F)		61		67		73		Entering Wet Bulb (°F)		61		67	
		CAP	SHC	CAP	SHC	CAP	SHC	CAP	SHC	CAP	SHC	CAP	SHC	CAP	SHC	CAP	SHC	CAP	SHC	CAP	SHC	CAP	SHC
		299	212	335	173	371	130	282	202	317	163	351	120	264	192	297	152	329	110	247	181	277	142
		300	245	336	206	371	164	283	235	318	196	351	154	265	225	298	186	329	143	247	214	278	175
		301	278	337	239	371	197	285	267	318	229	352	187	267	257	299	219	330	176	250	246	278	208
		305	305	337	272	372	230	291	291	319	262	352	220	276	276	299	252	330	210	261	261	279	241
		319	239	354	189	385	133	300	228	334	178	364	123	279	217	311	167	340	112	259	205	288	155
		320	281	355	230	386	175	301	270	335	219	364	165	281	257	312	208	340	154	261	245	289	197
		323	321	356	271	386	217	305	305	335	261	365	206	288	288	313	249	341	195	270	270	290	238
		338	338	357	313	387	258	322	322	337	302	365	248	304	304	315	289	341	237	285	285	292	277
		332	264	366	203	394	136	311	253	344	192	371	125	289	241	320	180	346	114	267	229	295	168
		334	312	367	252	395	186	314	300	345	241	371	175	293	288	321	229	346	164	271	271	296	217
		344	344	368	302	395	236	326	326	346	291	372	225	307	307	322	279	346	214	287	287	298	264
		361	361	370	349	395	285	343	343	349	338	372	274	323	323	326	326	346	263	302	302	302	319
		341	288	374	216	400	138	320	274	351	204	376	128	296	261	325	192	349	116	272	248	299	180
		346	343	374	274	400	196	325	325	351	262	376	186	303	303	326	250	349	174	282	282	300	237
		361	361	376	332	400	254	342	342	353	317	375	243	321	321	329	304	348	232	298	298	302	291
		378	378	380	380	400	312	358	358	358	358	376	301	336	336	336	336	349	289	311	311	312	312
		349	309	379	229	404	141	326	296	355	217	379	130	301	282	329	204	351	118	276	269	301	191
		356	356	380	295	403	207	336	336	356	283	378	196	314	314	330	271	350	184	290	290	302	254
		374	374	382	357	404	274	353	353	359	345	377	262	330	330	333	331	349	250	305	305	306	319
		390	390	390	390	406	340	368	368	368	368	379	328	343	343	344	344	350	311	316	316	316	316
		354	331	383	242	407	144	331	318	358	229	381	133	305	304	331	217	352	120	280	280	302	203
		367	367	384	316	407	219	345	345	359	300	379	206	321	321	332	286	350	194	296	296	303	272
		384	384	387	384	408	293	361	361	363	363	380	281	337	337	336	336	350	268	310	310	310	310
		398	398	398	398	410	363	374	374	374	374	382	350	347	347	347	347	351	336	318	318	318	318

Notes:

1. All capacities shown are gross and have not considered indoor fan heat. To obtain net cooling subtract indoor fan heat
2. CAP = Total Gross Capacity, SHC = Sensible Heat Capacity



**Table 17. Gross cooling capacities — 30 ton — high efficiency and high capacity (60 Hz)**

CFM	Ent DB (°F)	Ambient Temperature (°F)																							
		85						95						105						115					
		Entering Wet Bulb (°F)			Entering Wet Bulb (°F)			Entering Wet Bulb (°F)			Entering Wet Bulb (°F)			Entering Wet Bulb (°F)			Entering Wet Bulb (°F)			Entering Wet Bulb (°F)					
		61	67	73	61	67	73	61	67	73	61	67	73	61	67	73	61	67	73						
6000	75	325	226	366	188	410	147	389	137	289	204	325	166	366	125	269	193	304	154	343	115				
	80	326	259	367	221	411	181	389	170	289	237	326	199	366	159	270	226	305	187	344	148				
	85	327	292	367	254	411	214	390	203	291	269	327	232	367	192	272	258	306	221	344	181				
7500	90	329	324	368	287	412	247	390	237	297	297	328	265	367	225	281	281	306	254	345	215				
	75	349	255	391	206	435	154	329	243	369	194	411	142	307	230	345	182	386	131	322	170				
	80	350	296	392	247	435	196	330	284	370	235	411	184	309	271	346	223	387	173	323	211				
9000	85	353	336	393	288	436	237	333	324	371	277	412	226	312	312	347	264	388	214	324	253				
	90	365	365	394	330	437	279	348	348	372	318	413	267	329	329	348	306	389	256	311	293				
	75	366	281	408	221	451	158	344	268	384	209	426	147	320	255	358	196	399	135	333	184				
10500	80	368	329	409	271	452	209	346	316	385	259	427	197	323	303	359	246	400	185	300	290				
	85	374	374	410	321	453	258	355	355	386	308	428	247	335	335	361	296	401	235	315	315				
	90	395	395	413	369	454	308	376	376	389	356	429	297	355	355	365	343	402	285	335	335				
12000	75	378	306	420	236	463	163	355	293	394	223	436	151	329	277	368	210	408	139	305	263				
	80	382	361	422	294	464	221	359	348	396	281	438	209	335	334	369	268	409	197	312	312				
	85	397	397	424	350	465	279	377	377	398	337	439	268	355	355	372	324	411	255	333	333				
13500	90	419	419	428	407	466	337	398	398	403	394	440	326	376	376	378	378	412	313	354	354				
	75	388	328	430	250	471	166	363	314	402	237	444	154	337	299	375	224	414	142	311	285				
	80	394	393	431	316	473	233	371	371	404	303	445	221	348	348	377	290	416	208	326	326				
	85	416	416	434	379	474	299	394	394	408	366	447	288	371	371	381	352	417	275	348	348				
	90	439	439	440	440	475	366	417	417	417	417	448	351	393	393	394	394	419	338	370	370				
	75	396	350	437	264	478	170	370	336	409	250	450	158	343	321	380	237	419	145	317	306				
	80	407	407	438	338	479	245	384	384	411	322	451	233	360	360	383	307	421	220	336	336				
	85	431	431	443	408	480	320	408	408	416	395	452	307	384	384	388	381	422	295	359	359				
	90	455	455	455	455	482	390	432	432	432	432	455	377	407	407	407	407	424	364	381	381				

**Notes:**

1. All capacities shown are gross and have not considered indoor fan heat. To obtain net cooling subtract indoor fan heat
2. CAP = Total Gross Capacity, SHC = Sensible Heat Capacity



Performance Data

Table 18. Gross cooling capacities — 30 ton eFlex™ variable speed — high capacity (60 Hz)

CFM	Ent DB (°F)	Ambient Temperature (°F)																							
		85						95						105						115					
		Entering Wet Bulb (°F)			Entering Wet Bulb (°F)			Entering Wet Bulb (°F)			Entering Wet Bulb (°F)			Entering Wet Bulb (°F)			Entering Wet Bulb (°F)			Entering Wet Bulb (°F)					
61	67	73	61	67	73	61	67	73	61	67	73	61	67	73	61	67	73	61	67	73					
6000	75	321	224	362	186	405	145	343	176	385	135	324	203	324	165	364	125	269	193	304	154	344	115		
	80	322	257	362	219	405	179	344	209	385	169	325	236	325	198	365	158	270	226	305	188	344	148		
	85	323	290	363	252	406	212	307	279	386	202	289	268	325	231	365	192	272	258	306	221	345	182		
7500	90	326	323	363	285	406	245	310	310	345	275	387	235	296	296	326	264	281	281	307	254	346	215		
	75	344	252	386	203	429	152	325	241	365	192	407	141	305	230	343	181	285	218	322	170	361	120		
	80	346	294	387	245	430	193	327	283	366	234	407	183	307	270	344	223	287	258	323	212	362	162		
9000	85	348	334	387	286	430	235	330	323	367	275	408	224	311	311	345	264	294	294	324	253	363	203		
	90	361	361	389	328	431	277	345	345	368	317	409	266	328	328	347	305	312	312	326	293	364	245		
	75	361	278	402	219	445	156	340	267	380	207	422	146	318	255	356	196	296	243	334	184	372	124		
1050	80	363	326	403	269	446	206	343	314	381	257	423	196	321	302	358	245	300	290	335	234	374	174		
	85	370	370	405	318	447	256	353	353	383	307	424	246	334	334	359	295	316	316	337	282	375	224		
	90	391	391	407	366	447	306	373	373	386	354	425	295	354	354	363	342	336	336	341	331	376	273		
12000	75	373	304	414	234	456	160	351	289	390	222	432	149	328	276	366	210	305	263	342	198	380	127		
	80	377	359	416	292	457	219	355	346	392	280	433	208	333	333	368	268	312	312	344	256	382	185		
	85	393	393	418	348	458	277	373	373	394	335	435	266	353	353	371	323	334	334	347	311	383	243		
13500	90	415	415	422	405	459	335	395	395	399	392	436	324	375	375	377	377	355	355	356	356	384	301		
	75	383	325	423	248	465	164	359	312	398	235	439	153	335	298	373	223	312	285	348	211	385	130		
	80	389	389	425	314	466	231	367	367	400	302	441	220	346	346	375	290	326	326	350	274	387	196		
13500	85	411	411	428	377	467	297	390	390	404	364	442	286	369	369	379	352	348	348	355	339	388	263		
	90	434	434	435	435	468	364	413	413	414	414	444	349	392	392	393	393	370	370	371	371	390	325		
	75	391	348	430	261	471	168	366	334	404	249	445	156	341	320	378	236	317	307	352	224	389	132		
13500	80	402	402	432	333	472	243	381	381	407	320	447	231	359	359	381	307	337	337	355	294	390	207		
	85	426	426	436	406	473	317	405	405	412	393	448	306	383	383	387	380	360	360	361	361	392	282		
90	449	449	450	450	475	388	428	428	428	429	429	450	376	405	405	406	406	382	382	382	382	394	350		

Notes:

1. All capacities shown are gross and have not considered indoor fan heat. To obtain net cooling subtract indoor fan heat
2. CAP = Total Gross Capacity, SHC = Sensible Heat Capacity

**Table 19. Gross cooling capacities — 40 ton — standard efficiency (60Hz)**

CFM	Ent DB (°F)	Ambient Temperature (°F)																							
		85						95						105						115					
		Entering Wet Bulb (°F)			Entering Wet Bulb (°F)			Entering Wet Bulb (°F)			Entering Wet Bulb (°F)			Entering Wet Bulb (°F)			Entering Wet Bulb (°F)			Entering Wet Bulb (°F)					
	61	67	73	61	67	73	61	67	73	61	67	73	61	67	73	61	67	73							
	CAP	SHC	SHC	CAP	SHC	SHC	CAP	SHC	SHC	CAP	SHC	SHC	CAP	SHC	SHC	CAP	SHC	SHC	CAP	SHC	SHC				
8000	75	398	289	446	238	498	182	380	280	426	227	475	172	360	269	404	216	449	161	339	258	380	205	421	149
	80	399	333	447	282	498	227	381	323	427	272	475	217	361	313	404	261	449	206	340	302	380	249	422	194
	85	400	377	447	326	498	271	382	365	427	316	475	261	363	354	405	305	450	250	343	342	381	293	422	238
10000	75	405	405	448	370	498	315	389	389	428	359	476	305	373	373	406	349	450	294	356	356	382	337	423	282
	80	425	326	474	260	524	190	405	316	451	249	498	179	382	304	426	238	470	167	359	292	399	225	438	155
	85	426	381	475	315	524	245	406	371	452	305	499	235	384	356	427	293	470	223	361	344	400	281	439	210
12000	75	430	430	476	370	525	301	411	411	453	360	499	290	390	390	428	348	471	278	370	370	401	336	439	266
	80	447	447	477	425	525	356	430	430	454	415	500	345	411	411	430	401	471	334	391	391	403	386	440	321
	85	444	361	493	281	541	196	422	350	468	269	513	184	398	338	441	257	482	172	372	325	412	244	448	159
14000	75	447	423	494	347	541	262	425	412	469	336	514	251	402	399	442	323	483	239	377	377	413	311	449	226
	80	457	457	495	413	542	329	438	438	471	402	514	318	418	418	443	390	483	305	395	395	414	374	449	292
	85	481	481	498	474	543	395	462	462	474	463	515	384	440	440	448	448	484	371	416	416	419	419	450	358
16000	75	459	395	507	300	553	200	435	381	481	288	523	189	409	365	452	276	491	176	382	352	421	263	455	163
	80	464	464	508	377	553	278	441	441	482	366	524	267	416	416	453	353	491	254	392	392	422	340	455	241
	85	482	482	509	454	554	356	462	462	484	437	524	344	439	439	455	424	492	332	414	414	425	410	456	318
18000	75	507	507	515	515	554	433	486	486	490	490	525	421	462	462	463	463	492	409	435	435	435	435	456	395
	80	470	422	517	319	561	205	445	409	490	307	530	193	419	395	460	294	497	181	391	381	427	281	459	167
	85	478	478	518	407	561	294	455	455	491	395	531	282	431	431	461	382	497	269	406	406	428	365	460	256
18000	75	503	503	521	488	562	382	480	480	494	476	531	370	455	455	464	462	497	358	428	428	433	433	460	344
	80	528	528	529	529	562	470	504	504	505	505	532	459	478	478	478	478	498	442	447	447	448	448	460	423
	85	479	452	525	337	567	209	454	439	497	325	536	197	427	425	466	312	501	185	397	397	432	298	463	171
18000	75	492	492	526	436	568	309	470	470	498	421	536	297	444	444	467	403	501	284	417	417	433	388	462	270
	80	519	519	530	526	568	409	495	495	503	503	536	397	468	468	472	472	501	384	439	439	439	439	462	369
	85	544	544	544	544	568	504	518	518	519	519	537	486	489	489	490	490	501	472	456	456	456	456	462	456

**Notes:**

1. All capacities shown are gross and have not considered indoor fan heat. To obtain net cooling subtract indoor fan heat
2. CAP = Total Gross Capacity, SHC = Sensible Heat Capacity



Performance Data

Table 20. Gross cooling capacities — 40 ton — high efficiency and high capacity (60 Hz)

CFM	Ent DB (°F)	Ambient Temperature (°F)																							
		85						95						105						115					
		Entering Wet Bulb (°F)			Entering Wet Bulb (°F)			Entering Wet Bulb (°F)			Entering Wet Bulb (°F)			Entering Wet Bulb (°F)			Entering Wet Bulb (°F)			Entering Wet Bulb (°F)					
		61	67	73	61	67	73	61	67	73	61	67	73	61	67	73	61	67	73						
8000	75	423	302	474	250	530	195	453	239	506	184	381	279	429	227	479	173	359	267	403	215	450	160		
	80	424	346	475	294	530	240	435	283	506	229	382	323	429	271	479	217	360	311	404	259	450	205		
	85	425	390	475	338	530	284	405	378	507	273	384	366	430	315	480	261	362	353	405	303	451	249		
10000	90	430	430	476	382	530	328	414	414	507	317	396	396	431	359	481	306	378	378	406	347	452	293		
	75	452	339	504	273	559	203	429	327	480	261	532	192	405	315	453	249	380	302	425	236	470	166		
	80	453	394	505	328	559	258	431	382	481	317	533	247	407	370	455	304	382	355	426	291	471	222		
12000	85	457	448	506	383	559	314	436	435	482	372	533	303	415	415	456	359	394	394	427	346	472	277		
	90	477	477	507	438	560	369	458	458	484	427	534	358	438	438	458	413	416	416	430	399	472	332		
	75	473	374	525	294	577	208	449	362	499	282	549	197	422	349	470	269	395	335	439	255	483	171		
14000	80	475	438	526	360	578	275	452	426	501	348	550	264	427	412	472	335	400	398	441	321	484	238		
	85	488	488	528	426	578	342	468	468	502	414	550	330	446	446	474	401	422	422	443	386	484	304		
	90	514	514	531	490	579	408	494	494	506	478	551	396	471	471	478	464	446	446	448	448	485	370		
16000	75	488	407	540	313	590	213	463	395	513	301	561	202	436	378	483	288	407	364	450	274	491	176		
	80	493	482	541	390	590	291	470	469	514	378	561	280	444	444	484	365	419	419	451	351	492	253		
	85	516	516	544	468	591	368	495	495	517	452	562	357	471	471	487	438	444	444	455	424	493	330		
18000	90	543	543	549	541	591	445	521	521	524	524	562	434	496	496	497	497	468	468	469	469	494	408		
	75	501	437	552	332	599	218	475	423	523	319	569	206	446	409	492	306	416	394	457	292	497	180		
	80	510	510	553	420	599	306	488	488	525	408	569	295	463	463	493	394	436	436	459	376	498	268		
18000	85	539	539	556	504	599	395	516	516	529	491	569	383	490	490	498	477	461	461	465	462	498	356		
	90	566	566	567	567	600	483	542	542	543	543	570	471	515	515	516	516	484	484	485	485	500	439		
	75	511	467	560	350	606	222	485	454	531	338	575	211	455	439	498	324	424	423	463	310	502	184		
18000	80	528	528	562	449	606	322	505	505	533	435	575	310	478	478	500	418	449	449	466	403	502	283		
	85	557	557	566	543	606	421	533	533	538	530	575	409	505	505	507	507	474	474	475	475	502	382		
	90	584	584	585	585	607	515	558	558	559	559	576	502	529	529	530	530	496	496	496	497	504	473		

Notes:

1. All capacities shown are gross and have not considered indoor fan heat. To obtain net cooling subtract indoor fan heat
2. CAP = Total Gross Capacity, SHC = Sensible Heat Capacity

**Table 21. Gross cooling capacities — 40 ton eFlex™ variable speed — high capacity (60 Hz)**  
**Ambient Temperature (°F)**

CFM	Ent DB (°F)	85												95												105												115											
		Entering Wet Bulb (°F)						Entering Wet Bulb (°F)						Entering Wet Bulb (°F)						Entering Wet Bulb (°F)						Entering Wet Bulb (°F)						Entering Wet Bulb (°F)																	
		61	67	73	CAP	SHC	SHC	61	67	73	CAP	SHC	SHC	61	67	73	CAP	SHC	SHC	61	67	73	CAP	SHC	SHC	61	67	73	CAP	SHC	SHC																		
8000	75	418	299	468	247	192	398	288	447	237	500	182	378	277	425	226	475	171	358	266	402	214	449	160																									
	80	418	343	468	291	522	337	399	332	448	281	500	226	379	321	426	270	475	216	359	310	403	259	449	204																								
	85	420	386	469	335	522	281	401	375	448	325	500	271	381	364	426	314	476	260	361	353	403	303	450	249																								
	90	426	426	470	379	523	325	411	411	449	369	501	315	394	394	427	358	477	304	378	378	405	347	451	293																								
	75	445	336	497	270	549	199	424	325	474	259	525	189	401	313	449	247	498	178	378	301	423	235	469	166																								
	80	447	391	498	325	550	255	426	378	475	314	526	245	404	366	450	303	499	233	381	354	425	291	470	222																								
	85	452	444	499	380	550	310	432	429	476	369	526	300	413	413	452	358	500	289	394	394	426	346	471	277																								
	90	472	472	500	434	551	365	455	455	478	422	527	355	436	436	454	411	500	344	417	417	429	398	471	332																								
	75	465	371	517	290	567	205	442	358	493	279	541	195	418	346	466	267	513	183	394	332	438	255	482	171																								
	80	469	434	518	356	567	272	447	422	494	345	542	261	423	410	467	333	514	250	399	396	440	321	483	238																								
	85	483	483	520	422	568	338	464	464	496	410	542	327	444	444	470	397	514	316	422	422	442	384	483	304																								
	90	509	509	523	486	568	404	490	490	500	474	543	393	469	469	474	462	515	382	446	446	448	445	484	370																								
	75	481	401	531	310	579	210	457	389	506	298	552	199	432	376	478	286	523	188	406	362	449	273	490	176																								
	80	487	478	532	387	579	287	465	460	507	375	553	277	442	442	480	363	523	265	419	419	450	349	491	253																								
	85	511	511	535	460	579	364	490	490	510	449	553	354	468	468	483	436	524	342	444	444	454	423	492	330																								
	90	538	538	541	532	580	441	517	517	519	517	553	429	494	494	494	494	524	416	468	468	469	469	492	403																								
	75	493	432	542	328	588	214	469	420	516	317	561	204	442	406	487	304	530	192	415	392	456	291	497	180																								
	80	505	505	543	415	588	303	484	484	517	403	560	292	460	460	489	388	530	280	436	436	459	374	497	268																								
	85	533	533	547	499	587	390	511	511	522	487	560	380	487	487	494	474	530	369	462	462	464	460	497	354																								
	90	559	559	560	560	588	474	537	537	537	537	561	463	512	512	512	513	531	450	484	484	485	485	498	437																								
	75	503	463	550	346	595	219	478	450	523	335	567	208	451	436	493	322	536	197	424	421	462	309	502	184																								
	80	522	522	552	441	594	318	500	500	525	428	566	307	476	476	496	415	535	296	449	449	465	401	501	283																								
	85	551	551	557	537	593	417	528	528	531	523	565	404	502	502	504	503	535	389	475	475	475	475	501	375																								
	90	575	575	576	576	594	509	551	551	552	552	565	497	525	525	525	525	535	484	495	495	496	496	501	471																								

Notes:

1. All capacities shown are gross and have not considered indoor fan heat. To obtain net cooling subtract indoor fan heat
2. CAP = Total Gross Capacity, SHC = Sensible Heat Capacity



Performance Data

Table 22. Gross cooling capacities — 50 ton — standard efficiency (60Hz)

CFM	Ent DB (°F)	Ambient Temperature (°F)																							
		85						95						105						115					
		Entering Wet Bulb (°F)			Entering Wet Bulb (°F)			Entering Wet Bulb (°F)			Entering Wet Bulb (°F)			Entering Wet Bulb (°F)			Entering Wet Bulb (°F)			Entering Wet Bulb (°F)					
61	67	73	61	67	73	61	67	73	61	67	73	61	67	73	61	67	73	61	67	73					
		CAP	SHC	CAP	SHC	CAP	SHC	CAP	SHC	CAP	SHC	CAP	SHC	CAP	SHC	CAP	SHC	CAP	SHC	CAP	SHC				
10000	75	503	365	563	300	625	229	480	352	536	286	594	216	453	338	506	272	561	202	426	324	475	257	524	186
	80	504	420	564	355	624	285	481	407	537	342	594	272	455	393	507	327	561	257	427	379	476	312	524	242
	85	507	473	564	410	625	340	484	460	538	397	595	327	458	446	508	382	561	313	432	431	477	367	525	297
12500	75	535	411	595	327	654	237	509	397	565	313	620	223	479	382	532	298	583	208	448	366	496	282	542	192
	80	537	478	596	396	654	307	511	463	566	382	621	293	482	447	533	367	583	278	452	431	498	351	542	262
	85	544	544	597	464	655	376	519	519	567	451	621	362	494	494	534	435	584	347	468	468	499	420	543	331
15000	75	558	453	617	351	672	243	529	439	585	337	636	229	497	421	549	321	596	214	464	402	511	305	552	197
	80	563	532	618	434	673	327	534	517	586	420	637	313	504	501	550	404	597	297	471	471	512	388	553	280
	85	579	579	619	517	673	410	554	554	588	502	638	395	527	527	552	482	597	380	496	496	515	464	553	363
17500	75	609	609	624	594	674	492	583	583	593	579	638	478	553	553	559	559	598	462	521	521	522	522	554	446
	80	609	609	636	562	686	443	582	582	603	546	648	428	551	551	566	529	606	412	517	517	526	511	560	395
	90	639	639	644	644	686	539	610	610	612	612	649	525	578	578	578	578	578	505	541	541	542	542	560	483
20000	75	589	528	644	398	694	254	557	512	608	383	655	240	522	495	569	366	611	224	486	476	527	349	564	207
	80	601	601	645	508	694	365	572	572	610	493	655	350	541	541	571	470	611	334	507	507	529	451	564	317
	85	632	632	649	610	694	476	603	603	614	594	655	461	569	569	576	576	611	445	533	533	535	535	563	427
22500	75	662	662	662	662	695	582	630	630	631	631	656	567	595	595	595	595	612	545	554	554	555	555	564	525
	80	600	566	652	420	701	260	567	549	616	405	661	245	531	531	575	388	616	229	494	494	532	371	568	212
	85	619	619	654	537	701	384	589	589	617	521	661	369	556	556	577	503	616	353	519	519	534	483	567	336
90	650	650	660	657	701	508	619	619	624	624	660	493	583	583	585	585	607	607	607	607	607	616	587	567	567

Notes:

1. All capacities shown are gross and have not considered indoor fan heat. To obtain net cooling subtract indoor fan heat
2. CAP = Total Gross Capacity, SHC = Sensible Heat Capacity

**Table 23. Gross cooling capacities — 50 ton — high efficiency and high capacity (60 Hz)**

		Ambient Temperature (°F)																							
		85						95						105						115					
		Entering Wet Bulb (°F)						Entering Wet Bulb (°F)						Entering Wet Bulb (°F)						Entering Wet Bulb (°F)					
		61	67	73	CAP	SHC	SHC	61	67	73	CAP	SHC	SHC	61	67	73	CAP	SHC	SHC	61	67	73	CAP	SHC	SHC
Ent DB (°F)																									
10000	75	508	368	568	302	633	233	483	354	540	288	602	219	455	339	510	274	568	205	427	324	477	258	531	189
	80	509	423	569	357	633	288	484	409	541	344	602	275	457	394	511	329	568	260	428	378	479	314	532	245
	85	511	476	570	412	633	344	487	462	542	399	603	330	461	448	512	384	569	316	433	432	480	369	533	301
	90	522	522	571	467	634	399	502	502	544	454	604	386	480	480	514	439	570	371	456	456	482	422	534	356
12500	75	540	413	601	329	664	242	512	398	570	315	631	228	481	383	536	300	593	213	449	367	501	284	553	197
	80	543	480	602	398	665	311	515	465	572	384	632	297	485	449	538	369	594	282	454	432	502	353	554	266
	85	549	549	604	467	666	380	525	525	573	453	633	367	500	500	540	438	596	351	473	473	504	419	556	336
	90	577	577	607	534	667	449	554	554	577	519	634	436	528	528	544	503	597	421	500	500	509	487	557	405
15000	75	563	455	624	354	685	249	533	439	591	340	649	234	500	421	554	324	609	219	466	404	516	307	567	203
	80	568	535	625	437	686	332	539	519	592	422	651	318	507	503	556	407	611	302	476	476	518	390	569	286
	85	588	588	628	517	687	415	563	563	595	502	652	401	535	535	560	485	613	386	504	504	522	468	571	369
	90	620	620	633	599	689	498	594	594	602	584	654	484	564	564	567	567	614	469	533	533	534	534	572	451
17500	75	581	493	640	378	700	255	549	477	606	363	663	241	515	459	567	347	621	225	479	441	527	330	577	209
	80	589	588	642	475	701	352	560	560	608	460	664	338	531	531	570	440	623	322	499	499	530	422	579	306
	85	621	621	646	567	702	449	593	593	612	551	666	435	562	562	575	534	625	419	529	529	536	516	581	403
	90	653	653	656	656	704	545	625	625	626	626	668	527	593	593	594	594	627	510	558	558	559	559	583	493
20000	75	595	531	653	401	711	261	562	514	617	386	672	246	527	497	577	370	629	231	490	478	535	353	584	214
	80	612	612	655	507	712	372	583	583	619	491	674	357	551	551	580	474	632	342	517	517	539	455	587	325
	85	646	646	661	615	713	482	617	617	626	599	675	468	584	584	588	582	633	452	548	548	549	549	588	430
	90	679	679	680	680	715	586	649	649	650	650	678	571	614	614	615	615	636	554	577	577	578	578	592	537
22500	75	606	569	662	424	719	267	573	552	625	409	680	252	537	534	584	392	636	236	500	500	541	375	589	220
	80	632	632	665	541	721	391	602	602	629	525	682	377	568	568	589	507	638	361	532	532	546	488	592	344
	85	667	667	673	663	721	515	636	636	638	638	683	495	601	601	602	602	640	478	563	563	564	564	594	459
	90	700	700	701	701	724	630	668	668	669	669	686	615	631	631	632	632	644	598	592	592	593	593	599	580

**Notes:**

1. All capacities shown are gross and have not considered indoor fan heat. To obtain net cooling subtract indoor fan heat
2. CAP = Total Gross Capacity, SHC = Sensible Heat Capacity



Performance Data

Table 24. Gross cooling capacities — 50 ton eFlex™ variable speed — high capacity (60 Hz)  
Ambient Temperature (°F)

CFM	Ent DB (°F)	Ambient Temperature (°F)																							
		85						95						105						115					
		Entering Wet Bulb (°F)			Entering Wet Bulb (°F)			Entering Wet Bulb (°F)			Entering Wet Bulb (°F)			Entering Wet Bulb (°F)			Entering Wet Bulb (°F)			Entering Wet Bulb (°F)					
61	67	73	61	67	73	61	67	73	61	67	73	61	67	73	61	67	73								
	75	514	371	576	306	644	238	491	359	550	293	615	225	466	345	522	279	583	211	440	331	493	266	551	197
	80	515	426	577	361	644	293	492	413	551	348	615	280	468	400	523	335	584	267	442	386	494	321	551	253
10000	85	517	481	577	416	644	349	495	468	552	403	615	336	471	454	524	390	585	322	446	437	495	376	552	308
	90	528	526	578	471	645	404	508	508	553	458	616	391	488	488	525	445	585	378	467	467	497	431	553	364
	75	547	417	611	334	679	248	521	403	582	320	647	234	493	389	550	306	612	220	465	374	518	291	576	205
	80	550	485	612	403	680	317	524	471	583	389	647	304	496	457	552	375	613	289	468	441	520	360	577	275
12500	85	557	545	613	472	681	386	534	529	584	458	649	373	509	509	553	444	614	359	485	485	522	429	579	344
	90	582	582	616	540	682	456	561	561	587	526	650	442	537	537	557	512	616	428	512	512	526	496	580	414
	75	571	460	635	359	704	255	543	445	604	345	669	241	513	429	570	330	631	227	482	414	536	315	593	212
	80	576	541	637	442	705	339	548	525	605	428	670	325	520	507	572	413	633	310	491	485	538	398	595	296
15000	85	594	594	639	525	706	422	570	570	608	511	672	408	545	545	575	494	635	394	518	518	541	479	597	379
	90	627	627	644	605	707	505	602	602	614	591	673	491	576	576	583	569	636	477	548	548	552	547	599	462
	75	590	499	653	384	721	262	560	484	620	369	684	248	528	469	584	354	645	233	496	451	548	338	605	218
	80	598	584	655	480	723	360	571	564	622	466	686	346	542	542	587	451	647	331	513	513	551	435	607	316
17500	85	628	628	659	575	724	457	602	602	626	560	688	443	574	574	592	543	649	428	545	545	557	527	609	413
	90	663	663	670	655	726	554	636	636	640	636	690	540	607	607	608	608	652	525	576	576	577	577	613	508
	75	604	539	667	407	734	269	573	521	632	392	696	254	540	505	595	377	655	239	507	488	558	361	613	224
	80	620	620	669	518	736	380	592	592	635	503	698	366	563	563	598	485	658	351	533	533	561	469	617	336
20000	85	655	655	675	623	738	491	627	627	642	608	700	477	597	597	606	589	660	462	566	566	571	564	619	447
	90	692	692	694	694	741	602	663	663	664	664	704	585	632	632	633	633	664	570	599	599	600	600	624	554
	75	617	576	678	431	745	275	585	560	642	415	705	260	551	538	604	400	663	245	517	513	565	384	620	230
	80	640	640	681	552	747	400	611	611	645	537	708	386	581	581	608	520	666	370	549	549	569	500	624	355
22500	85	678	678	690	667	749	525	649	649	656	642	710	511	616	616	621	618	668	495	583	583	585	585	627	480
	90	716	716	717	717	753	647	686	686	686	686	715	632	652	652	653	653	674	612	618	618	618	618	633	596

Notes:

1. All capacities shown are gross and have not considered indoor fan heat. To obtain net cooling subtract indoor fan heat
2. CAP = Total Gross Capacity, SHC = Sensible Heat Capacity



Table 25. Gross cooling capacities — 55 ton — standard efficiency (60Hz)

CFM	Ent DB (°F)	Ambient Temperature (°F)																							
		85						95						105						115					
		Entering Wet Bulb (°F)			Entering Wet Bulb (°F)			Entering Wet Bulb (°F)			Entering Wet Bulb (°F)			Entering Wet Bulb (°F)			Entering Wet Bulb (°F)			Entering Wet Bulb (°F)					
61	67	73	61	67	73	61	67	73	61	67	73	61	67	73	61	67	73	61	67	73					
		CAP	SHC	CAP	SHC	CAP	SHC	CAP	SHC	CAP	SHC	CAP	SHC	CAP	SHC	CAP	SHC	CAP	SHC	CAP	SHC				
11000	75	552	401	614	327	676	247	525	386	584	312	643	233	496	370	551	296	605	217	465	354	516	280	565	200
	80	553	461	615	388	676	308	526	447	585	373	643	294	497	431	552	357	606	278	467	415	517	341	565	261
	85	556	521	616	448	676	369	530	506	586	433	644	355	501	490	553	418	606	339	472	472	518	401	566	322
13750	75	568	568	617	508	677	430	546	546	587	494	644	416	522	522	555	478	607	400	495	495	520	462	567	383
	80	585	449	646	355	703	254	555	434	613	340	667	239	522	417	576	323	626	223	488	400	537	306	582	206
	85	587	525	647	431	703	331	558	507	614	416	667	316	526	490	577	399	626	299	492	473	538	382	582	282
16500	75	595	595	648	507	703	408	569	569	615	491	667	392	541	541	579	475	627	375	511	511	540	458	583	358
	80	623	623	651	583	704	482	598	598	618	566	667	469	569	569	583	547	627	451	537	537	544	529	583	434
	85	608	495	667	381	719	260	576	479	631	366	681	245	540	462	592	348	638	228	503	442	551	331	592	211
19250	75	613	583	667	472	720	351	582	567	632	456	681	336	548	548	593	439	638	320	513	513	552	422	592	302
	80	634	634	682	512	730	372	602	602	645	496	690	357	570	570	605	479	646	340	534	534	561	461	598	322
	85	663	663	685	613	730	478	633	633	649	597	690	463	599	599	609	578	645	446	561	561	566	559	597	428
22000	75	693	693	694	694	731	584	661	661	662	662	691	569	624	624	625	625	646	549	584	584	584	584	598	527
	80	638	578	691	431	739	271	603	561	653	415	698	256	565	542	611	397	652	239	526	522	566	379	603	222
	85	654	654	692	552	738	392	623	623	655	536	697	377	588	588	613	512	651	360	550	550	568	492	601	345
24750	75	686	686	697	666	738	514	653	653	660	649	696	498	616	616	619	619	650	481	576	576	576	576	600	463
	80	714	714	714	714	741	636	679	679	680	680	698	616	639	639	640	640	651	593	595	595	595	595	601	573
	85	649	619	699	455	745	277	613	601	660	439	703	261	575	575	617	421	657	245	534	534	570	402	607	227
	75	672	672	701	588	745	414	639	639	662	568	701	398	602	602	619	548	654	380	562	562	573	528	604	363
	80	703	703	707	707	745	550	668	668	670	670	701	534	629	629	629	629	653	517	586	586	586	586	602	494
	85	729	729	730	730	748	681	692	692	693	693	705	660	649	649	650	650	656	641	603	603	603	603	605	605

Notes:

1. All capacities shown are gross and have not considered indoor fan heat. To obtain net cooling subtract indoor fan heat
2. CAP = Total Gross Capacity, SHC = Sensible Heat Capacity

Table 26. Gross cooling capacities — 55 ton — high efficiency and high capacity (60 Hz)

CFM	Ent DB (°F)	Ambient Temperature (°F)																							
		85						95						105						115					
		Entering Wet Bulb (°F)			Entering Wet Bulb (°F)			Entering Wet Bulb (°F)			Entering Wet Bulb (°F)			Entering Wet Bulb (°F)			Entering Wet Bulb (°F)			Entering Wet Bulb (°F)					
		61	67	73	61	67	73	61	67	73	61	67	73	61	67	73	61	67	73						
11000	75	543	397	608	325	678	249	516	382	578	310	644	235	487	367	545	294	607	219	456	351	510	278	568	203
	80	545	458	609	386	678	310	518	443	579	371	645	296	489	426	546	355	608	280	458	409	511	339	569	264
	85	548	516	610	446	679	371	522	502	580	432	646	357	494	486	547	416	609	341	465	465	513	400	570	325
	90	563	563	612	507	680	432	541	541	582	492	647	418	517	517	549	477	610	402	491	491	515	458	571	386
13750	75	577	446	642	355	711	259	547	431	609	339	674	244	514	414	572	323	633	227	479	395	534	306	590	211
	80	580	519	644	431	712	335	551	504	610	415	676	320	518	487	574	399	635	304	485	469	535	382	592	287
	85	590	590	646	506	714	412	565	565	613	491	677	397	537	537	576	475	637	380	508	508	538	455	594	364
	90	621	621	649	580	715	487	596	596	617	564	678	473	567	567	581	547	638	456	537	537	544	529	596	440
16500	75	601	493	666	382	734	267	568	473	630	366	694	251	533	455	591	349	650	234	497	437	550	332	605	217
	80	607	580	668	473	735	358	576	563	632	457	696	343	542	542	593	440	653	326	510	510	552	423	608	309
	85	632	632	671	561	737	450	604	604	636	544	698	435	574	574	597	527	655	418	541	541	557	508	610	401
	90	667	667	678	651	738	541	638	638	644	635	700	526	606	606	607	607	657	509	572	572	573	573	612	488
19250	75	619	533	684	408	749	274	585	516	646	392	708	258	548	497	604	375	663	241	510	478	561	357	615	224
	80	631	631	686	515	752	381	600	600	648	498	711	365	568	568	607	476	666	348	534	534	565	457	619	331
	85	666	666	691	615	753	487	636	636	654	598	713	472	602	602	614	580	668	455	567	567	572	561	621	438
	90	702	702	704	704	755	592	671	671	672	672	715	573	636	636	637	637	671	555	599	599	600	600	625	537
22000	75	634	575	696	434	761	280	599	557	657	417	719	265	561	538	614	400	672	247	521	519	569	381	624	230
	80	656	656	699	550	764	403	624	624	661	532	722	387	589	589	618	513	675	370	553	553	574	494	628	353
	85	694	694	707	669	765	524	661	661	669	651	723	509	625	625	628	628	677	489	587	587	588	588	630	467
	90	731	731	732	732	768	639	697	697	698	698	727	622	660	660	660	660	682	604	620	620	621	621	636	585
24750	75	647	617	706	459	771	287	610	599	666	442	727	271	572	572	622	424	679	254	533	533	576	398	630	236
	80	677	677	711	588	773	424	644	644	671	570	730	409	607	607	627	550	682	391	568	568	582	530	634	374
	85	716	716	721	721	774	558	682	682	683	683	732	538	643	643	644	644	685	519	603	603	604	604	637	500
	90	753	753	754	754	779	688	718	718	719	719	737	671	678	678	679	679	691	652	637	637	638	638	644	633

Notes:

1. All capacities shown are gross and have not considered indoor fan heat. To obtain net cooling subtract indoor fan heat
2. CAP = Total Gross Capacity, SHC = Sensible Heat Capacity

**Table 27. Gross cooling capacities — 55 ton eFlex™ variable speed — high capacity (60 Hz)**

CFM	Ent DB (°F)	Ambient Temperature (°F)																								
		85						95						105						115						
		Entering Wet Bulb (°F)			Entering Wet Bulb (°F)			Entering Wet Bulb (°F)			Entering Wet Bulb (°F)			Entering Wet Bulb (°F)			Entering Wet Bulb (°F)			Entering Wet Bulb (°F)						
		61	67	73	61	67	73	61	67	73	61	67	73	61	67	73	61	67	73							
	75	539	395	603	323	247	515	382	576	309	642	234	489	368	546	295	610	220	461	354	516	281	461	354	516	281
	80	541	456	604	383	308	516	442	577	370	643	295	490	428	547	356	610	281	463	414	517	342	463	414	517	342
11000	85	544	516	605	444	370	520	501	577	431	644	356	495	487	548	417	611	342	470	468	518	402	470	468	518	402
	90	559	559	606	505	430	539	539	579	491	645	417	517	517	550	477	612	403	495	495	521	463	495	495	521	463
	75	572	444	637	352	257	544	430	606	338	674	243	515	415	574	323	637	229	485	400	540	309	485	400	540	309
	80	575	519	638	428	334	548	505	608	414	675	320	519	488	575	399	638	305	490	473	542	385	490	473	542	385
13750	85	586	584	640	504	410	561	561	610	490	676	396	537	537	577	475	640	382	512	512	545	461	512	512	545	461
	90	616	616	644	579	486	592	592	614	565	677	472	567	567	582	548	641	458	541	541	550	533	541	541	550	533
	75	595	490	661	380	266	565	476	628	365	695	251	534	459	593	350	656	236	502	441	557	335	502	441	557	335
	80	601	578	662	471	338	573	562	630	456	696	343	543	540	595	441	658	328	514	514	559	426	514	514	559	426
16500	85	626	626	665	562	449	600	600	633	546	698	435	573	573	599	531	660	420	545	545	564	513	545	545	564	513
	90	660	660	673	650	541	634	634	642	631	700	526	606	606	610	607	662	511	577	577	578	578	577	577	578	578
	75	613	533	678	406	273	582	516	643	391	710	258	549	499	607	376	669	243	516	483	569	360	516	483	569	360
	80	625	623	680	513	380	597	597	646	498	712	366	567	567	609	482	672	350	538	538	572	467	538	538	572	467
19250	85	659	659	685	617	487	632	632	652	599	714	473	602	602	616	583	674	457	572	572	580	566	572	572	580	566
	90	696	696	700	700	594	668	668	669	669	717	580	637	637	638	638	677	562	605	605	606	606	605	605	606	606
	75	628	574	691	432	280	596	558	655	417	721	265	562	541	617	401	679	250	528	522	578	385	528	522	578	385
	80	648	648	694	554	403	620	620	658	536	724	388	589	589	621	519	682	372	558	558	582	500	558	558	582	500
22000	85	687	687	702	669	525	657	657	667	652	726	510	625	625	631	627	684	495	593	593	595	595	593	593	595	595
	90	726	726	727	727	644	695	695	696	696	731	629	662	662	663	663	690	609	629	629	629	629	629	629	629	629
	75	640	616	702	457	287	607	597	664	442	730	272	573	572	625	426	686	256	538	538	585	409	538	538	585	409
	80	669	669	706	591	425	639	639	669	572	733	410	607	607	630	554	690	394	574	574	591	537	574	574	591	537
24750	85	710	710	717	710	562	678	678	682	682	736	547	645	645	646	646	693	532	610	610	611	611	610	610	611	611
	90	750	750	751	751	782	696	696	717	717	718	718	682	682	683	683	700	659	647	647	648	648	647	647	648	648

**Notes:**

1. All capacities shown are gross and have not considered indoor fan heat. To obtain net cooling subtract indoor fan heat
2. CAP = Total Gross Capacity, SHC = Sensible Heat Capacity



Performance Data

Table 28. Gross cooling capacities — 60 ton — standard efficiency (60Hz)

CFM	Ent DB (°F)	Ambient Temperature (°F)																							
		85						95						105						115					
		Entering Wet Bulb (°F)			Entering Wet Bulb (°F)			Entering Wet Bulb (°F)			Entering Wet Bulb (°F)			Entering Wet Bulb (°F)			Entering Wet Bulb (°F)			Entering Wet Bulb (°F)					
61	67	73	61	67	73	61	67	73	61	67	73	61	67	73	61	67	73	61	67	73					
	75	600	436	670	356	743	272	571	420	638	340	707	256	540	403	602	323	667	239	506	385	564	305	623	220
	80	601	502	670	423	743	339	572	486	638	407	707	323	541	469	603	389	667	305	508	451	565	371	623	287
12000	85	603	568	671	489	744	405	575	552	639	473	707	389	545	532	604	455	667	372	513	513	566	437	624	353
	90	612	612	672	554	744	472	586	586	640	538	708	456	560	560	605	521	668	438	533	533	568	503	624	420
	75	638	490	708	389	780	282	605	473	672	372	739	265	570	454	632	353	694	247	532	435	590	334	645	227
	80	640	572	710	472	780	366	608	555	673	455	740	349	573	537	633	436	694	330	536	519	591	417	646	311
15000	85	647	647	711	554	781	449	617	617	675	537	740	432	583	583	635	519	695	413	551	551	592	499	646	394
	90	671	671	713	637	782	532	644	644	677	620	741	515	613	613	638	602	696	496	580	580	597	580	647	476
	75	665	541	735	419	804	290	629	523	696	401	760	273	591	504	652	382	711	253	550	484	606	361	659	233
	80	669	641	736	518	804	390	635	617	697	500	760	373	598	597	654	481	712	354	558	558	608	461	659	333
18000	85	684	684	738	617	805	490	653	653	699	599	761	472	621	621	656	580	713	453	585	585	610	560	660	433
	90	719	719	743	717	806	589	688	688	705	693	762	572	653	653	663	663	714	552	615	615	619	619	661	532
	75	685	590	754	447	820	297	647	572	712	429	774	279	607	552	666	409	722	259	564	528	617	388	667	239
	80	693	693	755	563	821	414	657	657	713	544	774	396	618	618	668	525	723	376	577	577	619	504	668	355
21000	85	719	719	758	679	822	530	686	686	717	661	775	512	649	649	672	637	724	492	610	610	624	611	669	472
	90	756	756	767	767	823	646	721	721	727	727	776	628	682	682	684	684	725	608	639	639	639	639	670	587
	75	701	638	768	475	832	304	662	620	724	455	784	285	619	591	676	435	730	265	575	568	625	414	673	244
	80	713	713	769	607	833	437	676	676	726	588	784	419	636	636	678	568	731	398	597	597	627	546	674	377
24000	85	748	748	774	740	834	570	712	712	731	716	785	551	672	672	685	685	732	531	628	628	635	635	674	510
	90	784	784	787	787	835	703	747	747	746	746	787	684	704	704	705	705	734	664	657	657	658	658	677	643
	75	714	686	779	502	841	310	673	657	733	482	791	291	629	629	683	461	736	271	584	584	631	440	677	249
27000	80	731	731	780	650	842	460	695	695	735	631	792	441	655	655	686	610	736	421	611	611	611	611	678	400
	85	770	770	787	787	843	610	732	732	743	743	792	591	689	689	695	695	737	570	643	643	644	644	678	549
	90	807	807	807	807	845	759	766	766	767	767	795	740	721	721	721	721	740	720	670	670	670	671	682	680

Notes:

1. All capacities shown are gross and have not considered indoor fan heat. To obtain net cooling subtract indoor fan heat
2. CAP = Total Gross Capacity, SHC = Sensible Heat Capacity

**Table 29. Gross cooling capacities — 60 ton — high efficiency and high capacity (60 Hz)**

CFM	Ent DB (°F)	Ambient Temperature (°F)																								
		85						95						105						115						
		Entering Wet Bulb (°F)			Entering Wet Bulb (°F)			Entering Wet Bulb (°F)			Entering Wet Bulb (°F)			Entering Wet Bulb (°F)			Entering Wet Bulb (°F)			Entering Wet Bulb (°F)						
		61	67	73	61	67	73	61	67	73	61	67	73	61	67	73	61	67	73							
12000	75	635	452	708	373	781	286	603	434	673	355	744	269	568	415	634	336	701	251	533	397	594	317	656	232	
	80	636	518	709	439	781	353	604	500	674	421	744	336	569	481	636	402	702	318	535	463	595	383	657	298	
	85	638	584	710	505	781	419	606	565	675	487	745	402	572	546	637	468	703	384	538	527	596	449	658	365	
15000	75	645	645	711	571	782	485	620	620	676	553	745	469	591	591	638	534	703	450	562	562	598	515	658	431	
	80	676	507	748	405	815	294	640	488	710	386	775	277	601	468	667	366	729	258	561	447	622	346	680	239	
	85	678	590	749	487	815	377	642	571	711	469	775	360	604	548	668	449	730	342	564	527	623	429	681	322	
18000	75	684	670	750	570	816	460	650	648	712	552	776	443	617	617	670	532	730	424	583	583	625	511	681	405	
	80	713	713	752	652	816	543	683	683	715	634	776	526	650	650	673	612	731	507	614	614	629	590	682	487	
	85	704	558	774	433	836	301	666	538	733	415	794	283	624	517	688	394	746	265	580	494	640	373	695	245	
21000	75	709	654	775	532	836	400	671	634	735	514	794	383	630	612	689	494	746	364	588	588	641	473	695	344	
	80	727	727	777	631	836	499	695	695	737	613	794	482	659	659	692	589	746	463	621	621	644	567	695	443	
	85	762	762	780	726	836	598	729	729	741	707	794	581	692	692	698	687	747	562	652	652	653	653	695	542	
24000	75	725	607	792	461	851	307	685	583	750	442	807	290	641	560	702	421	758	271	595	537	652	400	705	251	
	80	733	717	793	576	850	422	694	694	751	557	806	405	655	655	704	537	757	386	615	615	654	516	704	366	
	85	764	764	795	687	849	538	730	730	754	668	806	521	690	690	708	646	756	502	648	648	658	624	703	481	
27000	75	798	798	802	800	850	653	763	763	764	764	806	636	722	722	723	723	757	617	678	678	679	679	704	590	
	80	741	649	805	487	862	313	700	628	761	468	817	296	654	605	712	448	766	277	607	581	660	426	712	257	
	85	756	756	806	619	861	445	720	720	762	600	815	427	679	679	714	574	764	408	636	636	663	550	710	388	
27000	75	792	792	809	744	861	577	755	755	767	724	813	559	714	714	720	702	763	540	668	668	670	670	709	520	
	80	825	825	826	826	863	707	787	787	788	788	814	684	744	744	744	744	744	663	696	696	697	697	709	641	
	85	754	694	814	514	871	319	712	672	770	495	824	302	665	648	720	474	773	283	617	617	666	452	717	262	
27000	75	778	778	816	655	870	468	740	740	771	635	821	449	698	698	722	613	769	430	652	652	669	589	714	410	
	80	814	814	821	800	871	617	775	775	778	777	820	598	731	731	731	731	731	768	575	683	683	684	684	712	548
	85	845	845	846	846	875	757	804	804	805	805	823	736	758	758	758	758	758	768	714	708	708	708	708	713	691

**Notes:**

1. All capacities shown are gross and have not considered indoor fan heat. To obtain net cooling subtract indoor fan heat
2. CAP = Total Gross Capacity, SHC = Sensible Heat Capacity



Performance Data

**Table 30. Gross cooling capacities — 60 ton eFlex™ variable speed — high capacity (60 Hz)**  
**Ambient Temperature (°F)**

CFM	Ent DB (°F)	Ambient Temperature (°F)																							
		85						95						105						115					
		Entering Wet Bulb (°F)			Entering Wet Bulb (°F)			Entering Wet Bulb (°F)			Entering Wet Bulb (°F)			Entering Wet Bulb (°F)			Entering Wet Bulb (°F)			Entering Wet Bulb (°F)					
	61	67	73	CAP	SHC	SHC	61	67	73	CAP	SHC	SHC	61	67	73	CAP	SHC	SHC	61	67	73	CAP	SHC	SHC	
12000	75	635	453	707	372	775	284	606	436	675	356	741	268	575	419	640	339	704	252	546	403	604	321	664	235
	80	636	519	707	438	775	350	607	502	675	422	742	335	576	485	641	405	704	319	547	469	605	387	665	301
	85	638	584	708	504	776	417	609	567	676	488	742	402	579	550	642	471	705	385	550	532	606	453	665	368
	90	648	639	709	570	776	483	622	620	677	554	743	468	596	596	643	537	706	451	571	571	608	519	666	434
15000	75	675	507	744	403	807	291	642	489	710	386	770	275	607	471	672	369	730	259	573	453	632	350	686	241
	80	677	588	745	486	807	374	645	571	711	469	770	359	610	552	673	451	730	342	576	534	633	433	687	324
	85	685	662	746	568	807	457	655	641	712	552	771	441	623	618	674	534	730	424	592	592	635	515	687	407
	90	711	711	748	649	807	539	683	683	714	633	771	524	654	654	677	614	731	507	622	622	638	596	688	489
18000	75	703	557	769	431	826	297	668	539	732	414	788	281	630	518	692	396	745	264	592	499	649	377	700	247
	80	707	654	770	530	826	396	673	635	733	513	787	381	636	611	693	495	745	364	600	585	650	476	700	346
	85	724	724	771	628	825	495	695	695	735	610	787	480	663	663	695	592	745	462	629	629	653	573	699	445
	90	758	758	775	724	826	594	728	728	739	704	787	578	695	695	702	677	744	561	659	659	663	652	699	543
21000	75	723	603	785	458	839	303	686	585	747	441	800	287	646	563	705	422	756	270	606	542	661	403	709	252
	80	731	705	786	573	840	419	697	681	748	556	798	402	660	656	706	538	754	385	623	623	662	516	707	367
	85	760	760	788	686	840	535	728	728	751	668	797	517	693	693	710	647	753	500	655	655	666	627	706	482
	90	791	791	797	775	842	648	759	759	762	752	797	630	722	722	723	723	753	612	683	683	684	684	706	594
24000	75	738	647	797	484	851	309	700	628	758	467	808	293	659	607	714	448	764	276	618	586	668	429	716	258
	80	753	749	798	613	852	442	718	718	759	596	805	424	682	682	716	577	760	407	644	644	670	554	712	389
	85	786	786	801	740	853	575	752	752	763	722	805	556	714	714	721	691	758	538	674	674	678	664	710	516
	90	816	816	817	817	856	703	780	780	781	781	808	684	741	741	741	741	759	661	698	698	699	699	709	641
27000	75	750	692	806	510	860	316	712	672	765	493	815	299	670	644	721	474	770	281	628	614	674	454	721	263
	80	773	773	806	654	862	465	738	738	767	636	812	447	700	700	723	613	764	428	659	659	676	592	715	410
	85	805	805	812	777	863	611	769	769	774	753	813	592	730	730	732	727	762	572	687	687	688	688	712	552
	90	837	837	838	838	867	755	797	797	798	798	817	734	754	754	754	754	766	713	707	707	708	708	713	683

**Notes:**

1. All capacities shown are gross and have not considered indoor fan heat. To obtain net cooling subtract indoor fan heat
2. CAP = Total Gross Capacity, SHC = Sensible Heat Capacity

**Table 31. Gross cooling capacities — 70 ton — standard efficiency (60Hz)**

CFM	Ent DB (°F)	Ambient Temperature (°F)																							
		85						95						105						115					
		Entering Wet Bulb (°F)			Entering Wet Bulb (°F)			Entering Wet Bulb (°F)			Entering Wet Bulb (°F)			Entering Wet Bulb (°F)			Entering Wet Bulb (°F)			Entering Wet Bulb (°F)					
61	67	73	61	67	73	61	67	73	61	67	73	61	67	73	61	67	73	61	67	73					
		CAP	SHC	CAP	SHC	CAP	SHC	CAP	SHC	CAP	SHC	CAP	SHC	CAP	SHC	CAP	SHC	CAP	SHC	CAP	SHC				
14000	75	716	519	796	423	876	320	679	499	756	403	832	300	640	478	712	382	783	280	601	458	667	361	732	259
	80	717	598	797	502	876	399	681	578	757	482	832	380	642	557	713	461	784	359	604	537	668	440	733	338
	85	721	676	798	581	877	478	685	654	758	561	833	459	647	633	714	540	785	438	610	610	669	518	734	417
17200	90	737	737	800	659	878	557	707	707	760	639	834	538	674	674	717	618	786	517	640	640	672	597	735	496
	75	755	577	834	457	909	328	714	556	790	436	861	308	671	533	742	414	809	287	627	511	692	392	754	265
	80	758	674	835	553	909	426	718	651	791	533	862	406	675	627	743	511	809	385	632	604	694	489	755	363
20400	85	768	767	837	650	910	523	731	731	793	629	863	503	694	694	745	607	810	482	657	657	696	585	755	460
	90	803	803	840	747	910	619	768	768	797	723	863	600	730	730	750	700	811	578	691	691	702	677	756	557
	75	783	631	860	487	930	335	739	609	813	466	880	315	693	586	761	444	825	294	646	559	709	421	767	272
23600	80	789	742	861	602	930	451	747	719	814	581	880	431	701	696	763	559	825	409	657	657	711	536	768	387
	85	813	813	863	717	931	565	776	776	817	696	881	545	735	735	767	669	826	524	693	693	715	645	768	502
	90	852	852	870	826	931	680	814	814	824	805	882	660	772	772	776	776	827	639	727	727	727	727	769	617
26800	75	804	684	878	517	945	342	758	657	829	496	893	322	710	632	775	473	836	300	660	607	720	449	776	278
	80	814	811	879	650	945	475	771	771	830	628	893	455	727	727	777	605	836	433	683	683	722	582	776	411
	85	850	850	883	777	945	608	810	810	835	754	893	588	766	766	783	730	836	566	719	719	729	706	776	544
30000	90	889	889	893	893	946	740	848	848	848	848	894	720	801	801	802	802	837	699	752	752	753	753	778	672
	75	820	729	891	546	956	348	773	706	840	524	902	328	723	680	785	501	844	306	672	655	728	478	783	284
	80	838	838	893	697	955	499	796	796	842	675	902	479	751	751	788	649	843	457	704	704	731	620	782	435
30000	85	879	879	898	839	955	650	836	836	849	816	901	630	789	789	796	792	843	608	739	739	741	741	782	585
	90	917	917	918	918	956	801	873	873	874	874	903	776	823	823	824	824	845	748	770	770	771	771	784	723
	75	834	778	901	575	964	355	786	754	849	553	909	335	734	728	792	529	850	313	682	682	734	506	788	290
30000	80	861	861	903	744	963	524	817	817	852	713	908	503	769	769	796	688	848	481	719	719	738	662	786	459
	85	902	902	911	900	962	693	857	857	861	861	907	672	807	807	807	807	848	650	754	754	755	755	786	622
	90	938	938	939	939	967	851	891	891	892	892	910	828	838	838	839	839	850	804	782	782	783	783	788	778

**Notes:**

1. All capacities shown are gross and have not considered indoor fan heat. To obtain net cooling subtract indoor fan heat
2. CAP = Total Gross Capacity, SHC = Sensible Heat Capacity



Performance Data

Table 32. Gross cooling capacities — 70 ton — high efficiency and high capacity (60 Hz)

CFM	Ent DB (°F)	Ambient Temperature (°F)																							
		85						95						105						115					
		Entering Wet Bulb (°F)			Entering Wet Bulb (°F)			Entering Wet Bulb (°F)			Entering Wet Bulb (°F)			Entering Wet Bulb (°F)			Entering Wet Bulb (°F)			Entering Wet Bulb (°F)					
		61	67	73	61	67	73	61	67	73	61	67	73	61	67	73	61	67	73						
14000	75	708	515	794	422	889	324	671	495	753	402	845	305	632	474	710	381	797	285	592	453	667	360	749	265
	80	709	593	795	501	889	404	673	573	755	481	845	385	633	552	712	460	798	364	593	531	668	439	750	344
	85	710	671	796	579	890	483	674	650	756	559	846	464	636	628	713	539	799	444	598	598	669	518	751	424
17200	75	726	726	797	658	890	562	696	696	757	638	847	543	664	664	714	617	800	523	632	632	671	596	752	503
	80	748	573	836	457	931	337	707	552	792	436	883	316	663	529	744	415	831	295	620	508	697	393	779	274
	85	750	669	837	554	932	434	709	648	794	533	884	414	666	624	746	512	832	393	623	600	699	490	780	372
20400	75	757	755	839	650	933	532	721	721	795	630	886	512	685	685	748	608	834	491	650	650	701	587	782	470
	80	794	794	841	747	935	629	761	761	797	726	887	609	725	725	751	703	836	588	689	689	704	679	784	567
	85	777	628	866	490	961	346	733	606	819	469	910	326	686	583	768	446	854	304	640	561	718	424	798	283
23600	75	781	741	868	605	962	462	738	716	821	584	911	442	693	691	771	561	856	420	649	649	720	539	801	399
	80	805	805	870	719	964	578	769	769	824	698	913	557	731	731	773	676	858	536	692	692	723	652	804	514
	85	850	850	874	830	965	692	814	814	829	808	915	672	774	774	781	781	860	651	734	734	735	735	806	629
26800	75	799	682	889	521	982	355	753	659	839	500	928	334	704	633	786	477	870	312	656	606	733	454	812	290
	80	807	807	891	654	984	489	765	765	842	633	931	468	722	722	789	610	873	446	681	681	736	587	816	424
	85	848	848	894	787	985	622	810	810	846	766	933	602	768	768	793	736	876	580	725	725	742	713	819	558
26800	75	896	896	904	904	987	755	857	857	860	860	935	735	814	814	815	815	878	713	770	770	771	771	821	691
	80	817	732	907	552	998	363	769	705	855	530	942	342	719	680	800	507	882	319	669	655	745	484	823	297
	85	834	834	909	703	1000	515	794	794	858	681	945	494	750	750	803	658	886	472	707	707	748	635	827	450
30000	75	884	884	914	847	1002	667	843	843	864	824	948	646	798	798	811	800	889	623	753	753	758	758	830	601
	80	934	934	936	936	1004	818	892	892	894	894	950	797	846	846	847	847	892	775	799	799	800	800	833	744
	85	832	779	921	582	1010	371	783	754	867	560	953	349	732	729	810	536	892	327	682	682	754	513	831	304
30000	75	862	862	923	751	1013	541	820	820	871	729	957	520	774	774	814	701	896	497	728	728	758	677	836	475
	80	915	915	931	911	1015	710	871	871	881	881	959	689	824	824	828	828	899	667	776	776	777	777	838	644
	85	966	966	967	967	1017	880	921	921	923	923	962	854	872	872	874	874	903	826	823	823	824	824	843	802

Notes:

1. All capacities shown are gross and have not considered indoor fan heat. To obtain net cooling subtract indoor fan heat
2. CAP = Total Gross Capacity, SHC = Sensible Heat Capacity



**Table 33. Gross cooling capacities — 70 ton eFlex™ variable speed — high capacity (60 Hz)**  
**Ambient Temperature (°F)**

CFM	Ent DB (°F)	85												95												105												115																																																																																																																																																																																																																																																																																																																																																																																																																																																																																																																																																																																																									
		Entering Wet Bulb (°F)				Entering Wet Bulb (°F)				Entering Wet Bulb (°F)				Entering Wet Bulb (°F)				Entering Wet Bulb (°F)				Entering Wet Bulb (°F)				Entering Wet Bulb (°F)				Entering Wet Bulb (°F)																																																																																																																																																																																																																																																																																																																																																																																																																																																																																																																																																																																																																	
		61	67	73	79	61	67	73	79	61	67	73	79	61	67	73	79	61	67	73	79	61	67	73	79	61	67	73	79																																																																																																																																																																																																																																																																																																																																																																																																																																																																																																																																																																																																																		
	75	703	512	787	418	879	321	670	494	750	400	840	303	635	475	712	382	798	285	600	457	674	364	756	267		80	704	590	788	497	879	400	671	572	752	479	840	383	635	553	714	461	799	365	601	535	676	443	757	347		85	705	667	789	576	880	479	673	649	753	558	841	462	640	623	715	540	800	444	608	601	677	522	758	426		90	721	721	790	654	881	558	694	694	753	636	842	541	666	666	716	618	801	523	638	638	679	600	760	505		75	741	570	827	453	920	332	704	550	787	435	877	314	666	531	746	415	831	295	628	512	705	397	786	277		80	743	665	829	550	920	430	706	645	789	532	878	412	668	625	748	512	833	393	631	606	707	494	788	375		85	754	743	830	647	922	527	720	720	791	628	880	509	687	687	749	609	835	491	656	656	709	590	790	472		90	788	788	832	743	923	624	758	758	793	723	881	606	726	726	752	704	836	588	695	695	712	685	791	569		75	769	625	856	486	948	342	730	605	814	467	902	323	689	584	770	447	854	304	648	562	726	427	806	285		80	773	737	858	601	949	458	734	711	816	582	904	439	697	681	772	562	856	420	660	656	728	543	809	401		85	798	798	860	715	951	573	766	766	818	696	906	555	732	732	774	674	859	536	698	698	731	655	811	517		90	842	842	865	828	952	688	810	810	825	799	908	670	775	775	785	768	860	651	740	740	745	744	813	632		75	790	676	878	517	968	350	749	655	834	498	921	331	706	634	787	477	870	312	664	613	741	457	820	293		80	801	785	880	650	970	484	763	759	836	631	923	466	724	724	790	610	873	446	688	688	744	590	823	427		85	840	840	883	780	972	618	805	805	840	760	926	599	769	769	794	740	876	580	732	732	749	716	826	560		90	887	887	898	882	974	751	852	852	858	857	928	732	814	814	816	816	878	713	776	776	777	777	828	694		75	808	727	895	548	984	358	765	706	849	528	934	339	721	681	801	507	882	319	678	659	753	487	830	300		80	828	828	897	699	986	510	789	789	852	679	938	491	751	751	804	658	886	472	713	713	756	634	834	452		85	875	875	903	846	988	662	838	838	858	822	940	643	799	799	812	790	888	623	760	760	768	757	837	604		90	924	924	927	927	990	813	887	887	888	888	942	794	846	846	847	847	891	770	805	805	806	806	840	750		75	823	778	908	578	996	366	779	751	861	557	945	347	734	718	811	536	891	326	692	685	762	516	838	307		80	854	854	911	747	999	536	815	815	864	722	949	517	775	775	815	701	896	497	735	735	766	679	842	477		85	905	905	920	892	1000	706	866	866	877	858	951	687	824	824	831	830	898	667	783	783	785	785	845	647		90	955	955	956	956	1003	870	915	915	916	916	955	851	872	872	873	873	903	830	829	829	830	830	850	804

Notes:  
1. All capacities shown are gross and have not considered indoor fan heat. To obtain net cooling subtract indoor fan heat  
2. CAP = Total Gross Capacity, SHC = Sensible Heat Capacity



Performance Data

Table 34. Gross cooling capacities — 75 ton — standard efficiency (60Hz)

CFM	Ent DB (°F)	Ambient Temperature (°F)																							
		85						95						105						115					
		Entering Wet Bulb (°F)			Entering Wet Bulb (°F)			Entering Wet Bulb (°F)			Entering Wet Bulb (°F)			Entering Wet Bulb (°F)			Entering Wet Bulb (°F)			Entering Wet Bulb (°F)					
	61	67	73	61	67	73	61	67	73	61	67	73	61	67	73	61	67	73							
	CAP	SHC	SHC	CAP	SHC	SHC	CAP	SHC	SHC	CAP	SHC	SHC	CAP	SHC	SHC	CAP	SHC	SHC	CAP	SHC	SHC				
15000	75	746	546	827	442	905	329	706	525	785	421	860	309	664	503	738	399	810	288	625	483	691	378	757	267
	80	747	631	828	527	905	414	708	610	786	506	860	395	667	588	740	484	810	374	628	565	693	463	758	352
	85	752	713	829	611	906	499	714	692	787	591	861	480	674	670	741	569	811	459	638	638	694	547	759	438
	90	774	774	831	696	906	584	742	742	789	675	862	565	707	707	744	654	812	544	671	671	697	629	760	522
18000	75	780	600	860	472	932	336	737	578	814	451	884	316	692	555	764	429	831	295	647	533	714	406	776	273
	80	783	700	861	574	932	438	742	676	816	553	885	419	697	653	766	531	832	397	653	630	715	508	776	376
	85	794	794	862	676	933	540	759	759	817	655	885	521	720	720	768	632	832	499	681	681	718	610	777	477
	90	833	833	866	776	933	642	797	797	821	753	885	622	757	757	773	729	833	601	716	716	724	706	778	579
21000	75	805	651	882	501	950	342	760	628	834	480	900	323	712	605	782	457	845	301	664	576	729	434	788	280
	80	811	765	883	620	950	461	768	742	836	598	900	442	721	718	784	575	845	420	677	677	731	552	788	398
	85	838	838	885	738	950	580	800	800	839	715	900	560	758	758	787	689	845	539	714	714	735	665	788	517
	90	877	877	891	851	950	698	838	838	846	829	901	679	795	795	796	796	846	657	749	749	750	750	789	635
24000	75	824	698	898	529	964	349	778	672	849	507	912	329	728	647	795	484	856	307	678	621	739	461	797	285
	80	834	830	899	664	963	484	791	791	850	643	912	464	747	747	797	620	855	443	702	702	741	593	796	421
	85	872	872	903	793	962	619	832	832	855	771	911	600	786	786	802	747	854	578	739	739	747	722	795	556
	90	910	910	912	912	963	755	869	869	870	870	911	735	822	822	823	823	855	707	772	772	773	773	796	683
27000	75	840	742	910	556	974	355	792	718	860	534	921	335	741	692	804	511	864	313	689	666	747	487	804	291
	80	858	858	911	708	972	507	816	816	861	687	920	487	770	770	807	656	862	465	722	722	750	630	801	443
	85	899	899	916	851	972	659	856	856	867	829	918	639	808	808	814	804	860	618	758	758	759	759	800	595
	90	935	935	936	936	974	812	891	891	892	892	919	782	841	841	842	842	861	759	788	788	789	789	801	735
30000	75	853	788	920	583	982	361	804	763	868	561	929	341	752	737	811	537	870	320	699	699	753	513	809	297
	80	880	880	921	745	980	530	836	836	870	721	926	510	788	788	814	696	867	488	737	737	756	670	805	466
	85	920	920	927	909	980	700	875	875	878	878	924	679	825	825	825	825	865	657	772	772	773	773	804	624
	90	954	954	955	955	985	859	908	908	909	909	926	836	855	855	842	842	866	811	800	800	800	800	805	786

Notes:

1. All capacities shown are gross and have not considered indoor fan heat. To obtain net cooling subtract indoor fan heat
2. CAP = Total Gross Capacity, SHC = Sensible Heat Capacity

**Table 35. Gross cooling capacities — 75 ton — high efficiency and high capacity (60 Hz)**

CFM	Ent DB (°F)	Ambient Temperature (°F)																									
		85						95						105						115							
		Entering Wet Bulb (°F)			Entering Wet Bulb (°F)			Entering Wet Bulb (°F)			Entering Wet Bulb (°F)			Entering Wet Bulb (°F)			Entering Wet Bulb (°F)			Entering Wet Bulb (°F)							
		61	67	73	61	67	73	61	67	73	61	67	73	61	67	73	61	67	73								
15000	75	753	550	843	449	942	344	442	344	714	529	801	428	896	323	672	507	755	406	845	302	630	485	709	385	794	281
	80	754	634	844	534	942	429	513	896	613	802	513	896	409	673	591	757	492	845	388	632	569	711	470	795	366	
	85	756	718	845	619	943	515	717	695	803	598	897	494	677	673	758	576	847	473	640	640	640	712	555	797	452	
18000	75	774	774	846	703	944	600	742	742	805	682	898	579	709	709	709	709	709	709	709	709	709	709	709	709	709	709
	80	790	604	882	482	980	354	747	582	836	461	930	333	702	559	786	438	875	311	656	536	737	416	821	289		
	85	792	706	884	584	980	457	749	683	838	563	931	436	704	659	788	540	876	414	660	634	739	518	822	392		
21000	75	799	799	885	686	982	559	761	761	839	664	932	539	724	724	790	642	878	517	687	687	741	619	824	495		
	80	837	837	887	787	983	661	803	803	842	766	934	641	765	765	793	743	880	619	727	727	745	717	826	597		
	85	817	656	911	513	1007	363	772	633	862	491	954	342	724	610	809	468	896	319	676	586	757	445	839	297		
24000	75	821	771	913	632	1008	483	776	747	864	610	955	462	730	723	811	587	898	439	686	686	759	564	841	417		
	80	844	844	915	750	1009	602	807	807	866	729	957	581	767	767	814	705	900	559	726	726	762	683	843	536		
	85	890	890	919	867	1011	721	852	852	871	842	959	700	811	811	821	818	902	678	770	770	774	774	845	655		
27000	75	838	707	933	543	1027	371	791	684	881	520	971	349	741	657	826	496	911	326	691	629	772	473	852	304		
	80	846	837	935	679	1028	508	801	801	884	656	973	486	756	756	829	632	914	463	713	713	774	609	855	441		
	85	885	885	937	814	1030	644	845	845	887	792	975	623	802	802	833	765	916	600	759	759	779	737	857	577		
30000	75	934	934	946	944	1031	780	893	893	898	898	977	759	849	849	849	849	850	736	804	804	805	805	859	713		
	80	856	757	950	572	1042	378	807	730	897	549	985	357	755	701	839	524	923	333	704	675	783	501	862	311		
	85	871	871	952	724	1044	532	828	828	899	701	987	511	783	783	842	677	926	487	738	738	786	654	866	465		
30000	75	920	920	956	874	1045	685	878	878	904	851	989	664	832	832	849	822	928	641	786	786	794	794	868	618		
	80	971	971	974	974	1046	838	927	927	929	929	991	817	880	880	881	881	931	794	832	832	833	833	870	767		
	85	871	803	963	600	1054	386	821	774	909	577	996	364	768	747	850	552	932	340	716	716	792	528	870	317		
30000	75	897	897	966	770	1056	556	854	854	912	746	998	535	807	807	853	722	936	511	760	760	795	693	874	488		
	80	950	950	973	931	1057	727	905	905	920	907	1000	705	857	857	864	864	938	682	808	808	811	811	875	658		
	85	1001	1001	1003	1003	1059	896	955	955	957	957	1003	875	905	905	907	907	941	847	854	854	856	856	880	817		

**Notes:**

1. All capacities shown are gross and have not considered indoor fan heat. To obtain net cooling subtract indoor fan heat
2. CAP = Total Gross Capacity, SHC = Sensible Heat Capacity

**Table 36. Gross cooling capacities — 75 ton eFlex™ variable speed — high capacity (60 Hz)**  
 Ambient Temperature (°F)

CFM	Ent DB (°F)	85												95												105												115																																																													
		Entering Wet Bulb (°F)						Entering Wet Bulb (°F)						Entering Wet Bulb (°F)						Entering Wet Bulb (°F)						Entering Wet Bulb (°F)						Entering Wet Bulb (°F)																																																																			
		61	67	73	CAP	SHC	SHC	61	67	73	CAP	SHC	SHC	61	67	73	CAP	SHC	SHC	61	67	73	CAP	SHC	SHC	61	67	73	CAP	SHC	SHC																																																																				
15000	75	755	551	846	451	942	344	442	344	718	531	805	430	898	325	679	510	762	410	850	304	639	489	718	389	800	284	756	635	847	535	942	430	719	615	806	515	898	410	679	594	763	494	850	390	640	571	720	474	801	369	757	717	848	620	943	515	720	689	807	600	899	495	685	659	764	579	851	475	650	634	721	558	803	454	774	774	849	704	944	599	745	745	808	684	900	580	713	713	765	663	853	560	681	681	722	641	804	539
18000	75	792	605	884	483	978	354	454	354	752	584	840	462	930	334	709	562	793	441	878	313	666	541	746	419	825	291	794	706	886	585	979	457	753	683	841	564	931	437	711	661	795	543	879	415	669	633	748	521	826	394	803	782	887	686	980	559	767	754	843	665	932	539	729	729	796	644	881	517	694	694	749	622	828	496	839	839	889	787	981	660	805	805	845	764	934	640	770	770	799	742	882	619	734	734	753	711	829	598
21000	75	820	657	912	514	1003	362	462	362	777	635	865	492	952	342	731	613	815	470	897	320	685	588	765	448	840	298	823	773	914	632	1004	482	781	745	867	611	953	461	738	706	818	589	899	439	697	675	767	567	842	417	845	845	916	750	1005	600	810	810	869	729	955	580	772	772	820	707	900	558	733	733	770	682	844	536	891	891	920	866	1006	719	855	855	875	833	956	699	816	816	829	795	902	677	776	776	784	762	845	655
24000	75	842	708	933	543	1020	369	469	369	796	685	884	521	967	348	748	659	832	498	910	326	701	635	779	476	851	304	849	816	935	678	1022	506	808	784	887	657	969	485	764	753	834	634	912	463	721	721	782	611	853	440	887	887	938	813	1023	641	848	848	890	788	971	621	807	807	838	765	914	599	765	765	787	740	855	576	934	934	948	913	1024	777	895	895	904	881	972	756	853	853	857	850	915	734	808	808	809	809	856	711
27000	75	859	754	950	571	1033	376	476	376	812	731	899	549	979	355	763	706	845	526	920	333	714	673	790	503	859	310	875	862	952	724	1035	529	832	832	901	702	980	508	788	788	847	679	922	486	746	746	793	655	861	463	921	921	956	872	1036	682	880	880	906	849	982	661	836	836	854	811	923	638	791	791	802	767	862	615	970	970	975	968	1037	834	928	928	930	930	983	813	882	882	883	883	925	791	834	834	835	835	864	762
30000	75	874	802	963	599	1043	382	482	382	826	778	910	577	988	361	776	738	855	553	927	339	726	696	798	530	865	316	898	898	965	768	1045	552	857	857	913	746	989	531	812	812	857	718	929	509	766	766	801	694	866	486	950	950	971	923	1045	722	907	907	921	885	989	701	860	860	870	841	930	678	812	812	817	807	867	655	998	998	1000	1000	1046	891	954	954	955	955	991	864	905	905	906	906	932	841	853	853	843	843	870	812

Notes:

- 1. All capacities shown are gross and have not considered indoor fan heat. To obtain net cooling subtract indoor fan heat
- 2. CAP = Total Gross Capacity, SHC = Sensible Heat Capacity

# Heating Capacities

**Table 37. Electric heat kW ranges**

Tons	Nominal Voltage			
	208	230	460	575
20	22.5-45-67.5	30-60-90	30-60-90	30-60-90
25	22.5-45-67.5	30-60-90	30-60-90	30-60-90
30	22.5-45-67.5	30-60-90	30-60-90	30-60-90
40	45-67.5-84	60-90-112	60-90-120-150	60-90-120-150
50	45-67.5-84	60-90-112	60-90-120-150	60-90-120-150
55	45-67.5-84	60-90-112	60-90-120-150	60-90-120-150
60	67.5-84	90-112	90-120-187	90-120-190
70	67.5-84	90-112	90-120-187	90-120-190
75	67.5-84	90-112	90-120-187	90-120-190

**Notes:**

- Actual limits may be + or - the values shown; to accurately calculate capacities, contact the local Trane Sales Office or utilize TOPSS.
- Follow the supply CFM ranges posted in the General Data for each case size.

**Table 38. Electric heat air temperature rise (°F)**

kW Input	Total MBh	CFM									
		4000	6000	9000	12000	15000	18000	21000	24000	27000	30000
30	102.5	23.6	15.7	10.5	7.9						
60	204.9	47.2	31.5	21.0	15.7	12.6	10.5	9.0			
90	307.4		47.2	31.5	23.6	18.9	15.7	13.5	11.8	10.5	9.4
120	409.8			41.9	31.5	25.2	21.0	18.0	15.7	14.0	12.6
150	512.3			52.4	39.3	31.5	26.2	22.5	19.7		
190	648.9				49.8	39.8	33.2	28.5	24.9	22.1	19.9

**Notes:**

- Air temperature rise = kW x 3415 ÷ (scfm x 1.085)
- See Electrical Data for electrical sizing information.
- 200 and 230 volt electric heat rooftops require dual power supplies to the control box. All other rooftops have single power connections.

**Table 39. Natural gas heating capacities**

Tons	Gas Heat Modules	Heat Input (MBh)	Heat Output (MBh)	Air Temperature Rise (°F) vs. Unit CFM									
				CFM									
				4000	5000	6000	6250	7000	8000	9000	10000	10625	11000
20	LOW	250	203	46.7	37.3	31.1	29.9	26.7	23.3	20.7			
	MEDIUM	350	284			43.5	41.8	37.3	32.7	29.0			
	HIGH	500	405				59.7	53.3	46.7	41.5			
25	LOW	250	203		37.3	31.1	29.9	26.7	23.3	20.7	18.7	17.6	17.0
	MEDIUM	350	284			43.5	41.8	37.3	32.7	29.0	26.1	24.6	23.8
	HIGH	500	405				59.7	53.3	46.7	41.5	37.3	35.1	33.9
30	LOW	250	203			31.1	29.9	26.7	23.3	20.7	18.7	17.6	17.0
	MEDIUM	350	284			43.5	41.8	37.3	32.7	29.0	26.1	24.6	23.8
	HIGH	500	405				59.7	53.3	46.7	41.5	37.3	35.1	33.9
40	LOW	350	284						32.7	29.0	26.1	24.6	23.8
	MEDIUM	500	405						46.7	41.5	37.3	35.1	33.9
	HIGH	850	689									59.7	57.7
50	LOW	350	284								26.1	24.6	23.8
	MEDIUM	500	405								37.3	35.1	33.9
	HIGH	850	689									59.7	57.7
55	LOW	350	284										23.8
	MEDIUM	500	405										33.9
	HIGH	850	689										57.7



## Performance Data

**Table 39. Natural gas heating capacities (continued)**

Tons	Gas Heat Modules	Heat Input (MBh)	Heat Output (MBh)	Air Temperature Rise (°F) vs. Unit CFM										
				CFM										
				4000	5000	6000	6250	7000	8000	9000	10000	10625	11000	
60	LOW	500	405											
	MEDIUM	850	689											
	HIGH	1200	972											
70	LOW	500	405											
	MEDIUM	850	689											
	HIGH	1200	972											
75	LOW	500	405											
	MEDIUM	850	689											
	HIGH	1200	972											
Tons	Gas Heat Modules	Heat Input (MBh)	Heat Output (MBh)	Air Temperature Rise vs. Unit CFM										
				CFM										
				11250	12000	13500	14000	15000	18000	22500	24000	27000	30000	
20	LOW	250	203											
	MEDIUM	350	284											
	HIGH	500	405											
25	LOW	250	203	16.6										
	MEDIUM	350	284	23.2										
	HIGH	500	405	33.2										
30	LOW	250	203	16.6	15.6									
	MEDIUM	350	284	23.2	21.8	19.4	18.7							
	HIGH	500	405	33.2	31.1	27.6	26.7							
40	LOW	350	284	23.2	21.8	19.4	18.7	17.4	14.5					
	MEDIUM	500	405	33.2	31.1	27.6	26.7	24.9	20.7					
	HIGH	850	689	56.4	52.9	47.0	45.3	42.3	35.3					
50	LOW	350	284	23.2	21.8	19.4	18.7	17.4	14.5					
	MEDIUM	500	405	33.2	31.1	27.6	26.7	24.9	20.7	16.6				
	HIGH	850	689	56.4	52.9	47.0	45.3	42.3	35.3	28.2				
55	LOW	350	284	23.2	21.8	19.4	18.7	17.4	14.5					
	MEDIUM	500	405	33.2	31.1	27.6	26.7	24.9	20.7	16.6	15.6			
	HIGH	850	689	56.4	52.9	47.0	45.3	42.3	35.3	28.2	26.4			
60	LOW	500	405		31.1	27.6	26.7	24.9	20.7	16.6	15.6			
	MEDIUM	850	689		52.9	47.0	45.3	42.3	35.3	28.2	26.4	23.5		
	HIGH	1200	972				64.0	60.0	50.0	40.0	38.0	33.0	30.0	
70	LOW	500	405				26.7	24.9	20.7	16.6	15.6			
	MEDIUM	850	689				45.3	42.3	35.3	28.2	26.4	23.5	21.2	
	HIGH	1200	972				64.0	60.0	50.0	40.0	38.0	33.0	30.0	
75	LOW	500	405				26.7	24.9	20.7	16.6	15.6			
	MEDIUM	850	689				45.3	42.3	35.3	28.2	26.4	23.5	21.2	
	HIGH	1200	972				64.0	60.0	50.0	40.0	38.0	33.0	30.0	

**Notes:**

- Actual limits may be + or - the values shown; to accurately calculate capacities, contact the local Trane Sales Office or utilize TOPSS.
- Follow the supply CFM ranges posted in the General Data for each case size.
- All heaters are 81% efficient.
- CFM values below the minimum and above the maximum shown in this table are not cULus approved.
- Air temperature rise = heat output (Btu) ÷ (CFM x 1.085).

## Fan Performance

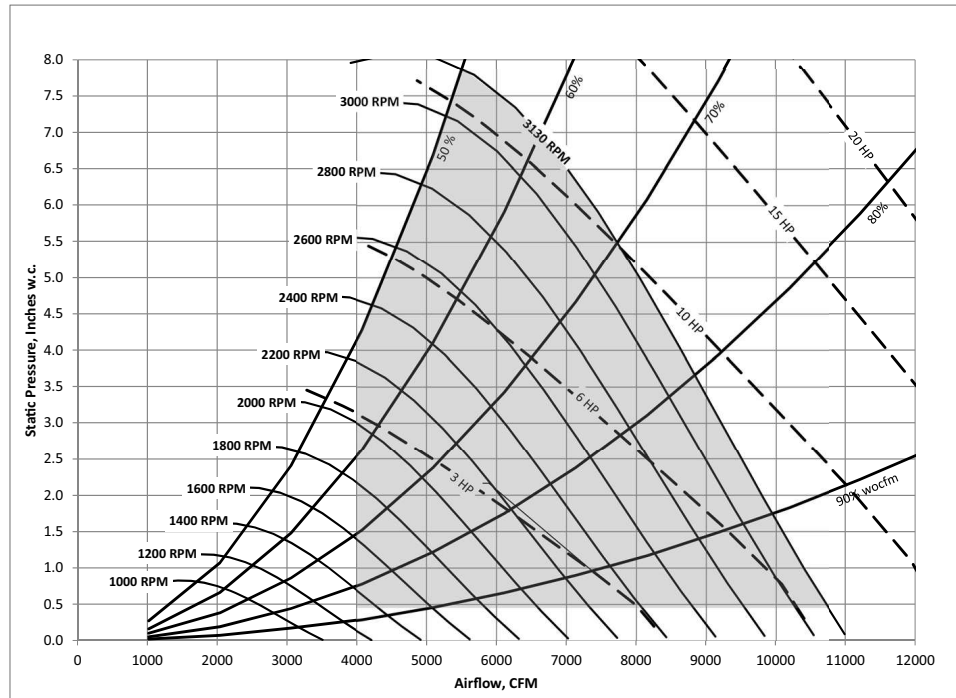
### Supply Fan Curves

Please see notes below for all supply fan curves. For additional information or support, contact your local Trane sales office or Trane representative.

**Important:**

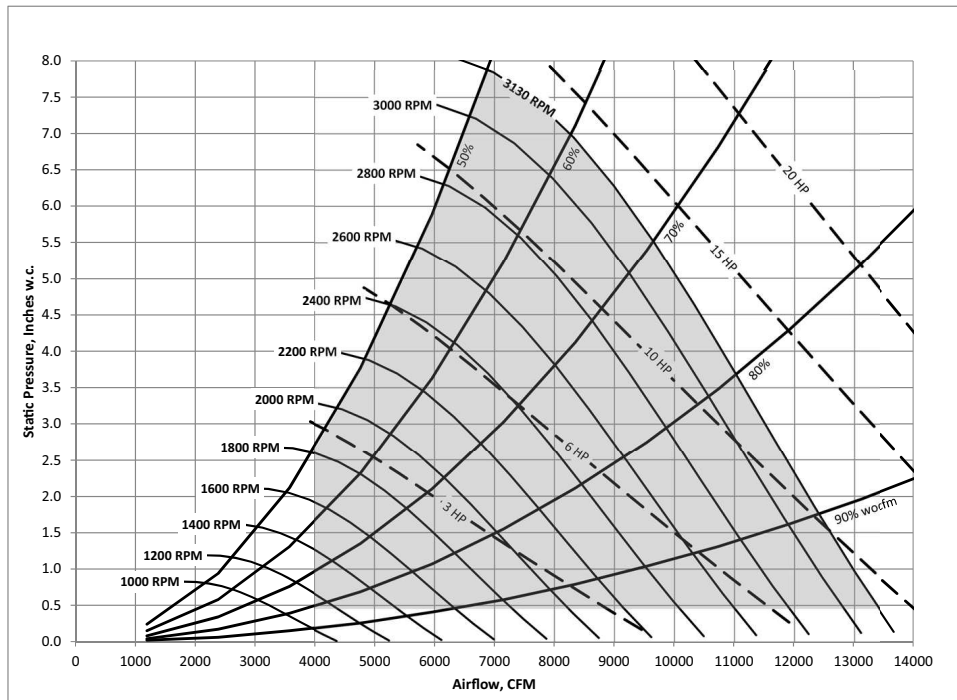
1. Shaded area represents selectable area.
2. Supply fan performance curve includes internal resistance of rooftop. To determine total static pressure, add system external static pressure to appropriate component static pressure drops (evaporator coil, filters, economizer, reheat coil, heating system, final filters).
3. Motor horsepower offerings are designated by horsepower lines shown on fan performance map.

**Figure 11. 20, 25 and 30 ton, 16.5 inch - 9 Blade - 80% width supply fan**



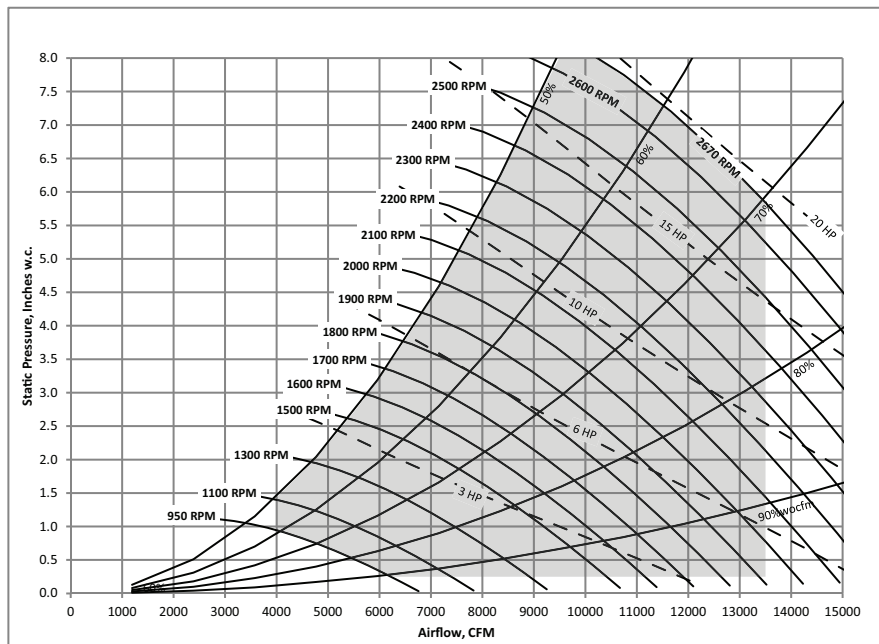
**Note:** Maximum airflow (for cULus approval) as follows: 20 ton - 9000 CFM, 25 ton - 11,250 CFM, 30 ton - 13,500 CFM

**Figure 12. 20, 25 and 30 ton, 16.5 inches - 9 blade - 100% width supply fan**



**Note:** Maximum airflow (for cULus approval) as follows: 20 ton - 9000 CFM, 25 ton - 11,250 CFM, 30 ton - 13,500 CFM

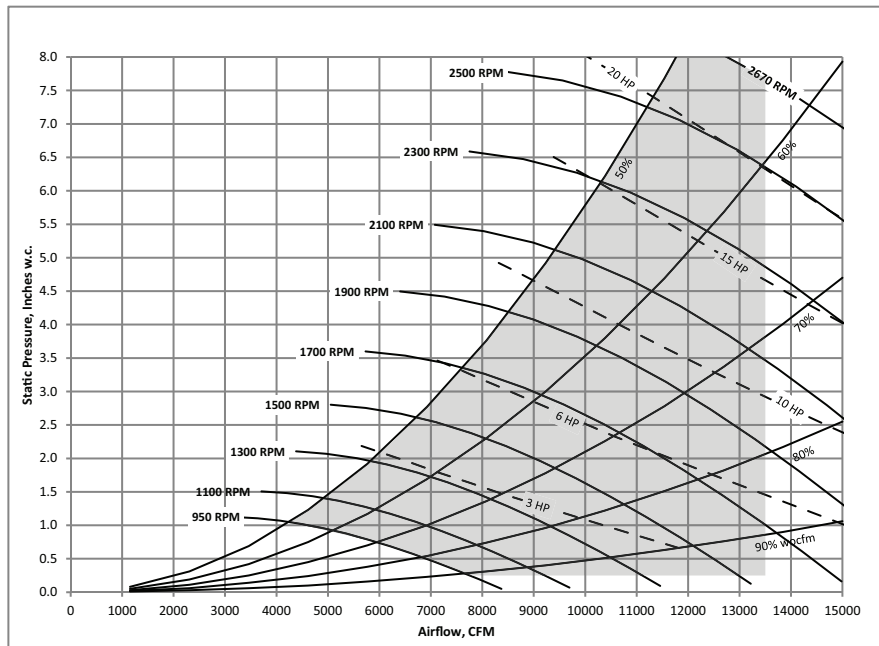
**Figure 13. 20, 25 and 30 ton, 20.0 inch - 9 blade - 80% width supply fan**



**Note:** Maximum airflow (for cULus approval) as follows: 20 ton - 9000 CFM, 25 ton - 11,250 CFM, 30 ton - 13,500 CFM

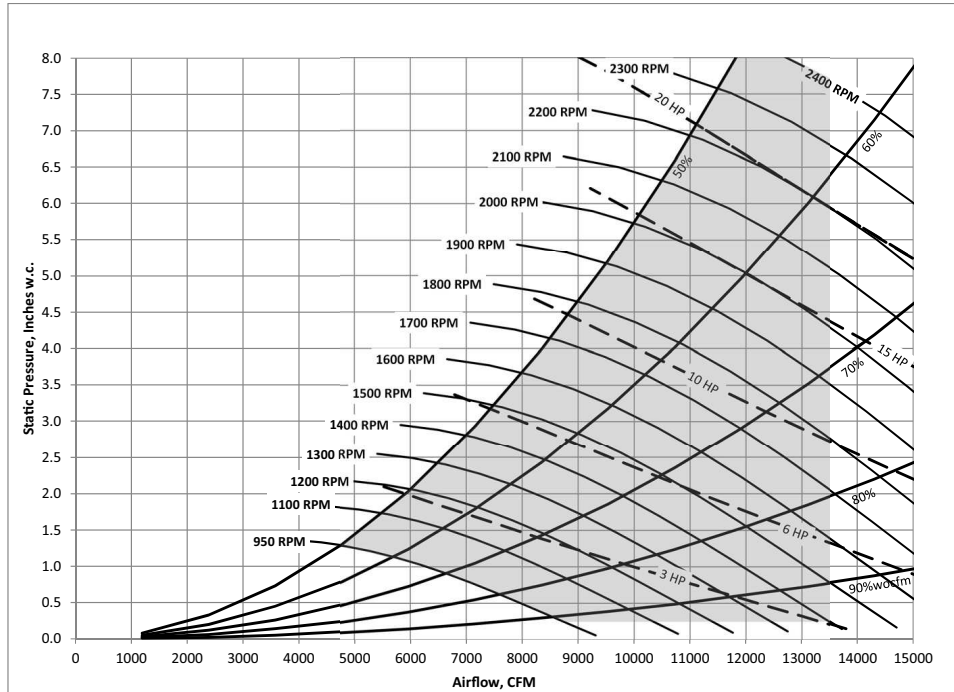


**Figure 14. 20, 25 and 30 ton, 20.0 inch - 9 blade - 100% width supply fan**



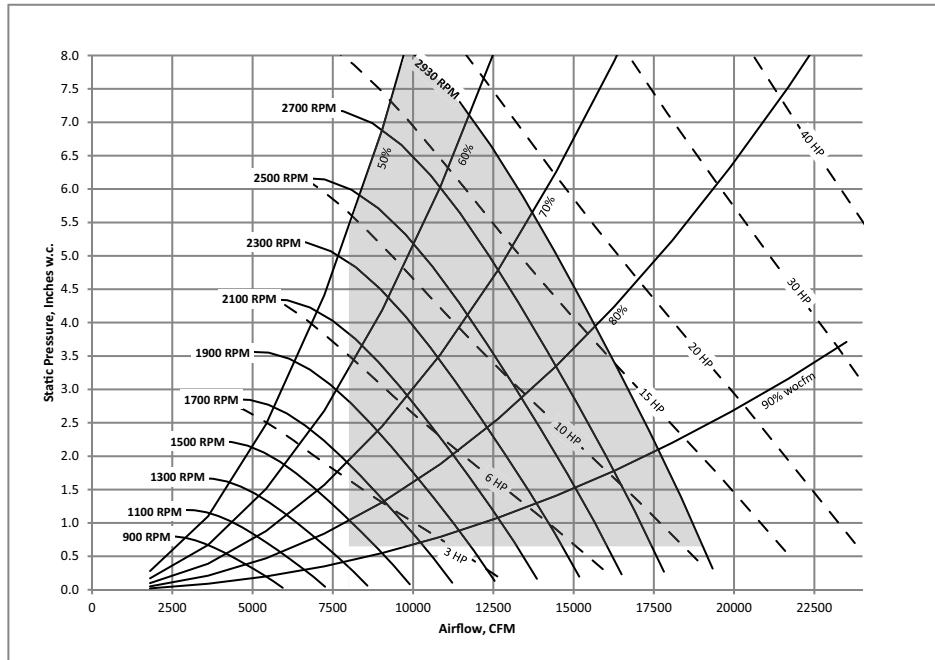
**Note:** Maximum airflow (for cULus approval) as follows: 20 ton - 9000 CFM, 25 ton - 11,250 CFM, 30 ton - 13,500 CFM

**Figure 15. 20, 25 and 30 ton, 22.2 inch - 9 blade - 80% width supply fan**



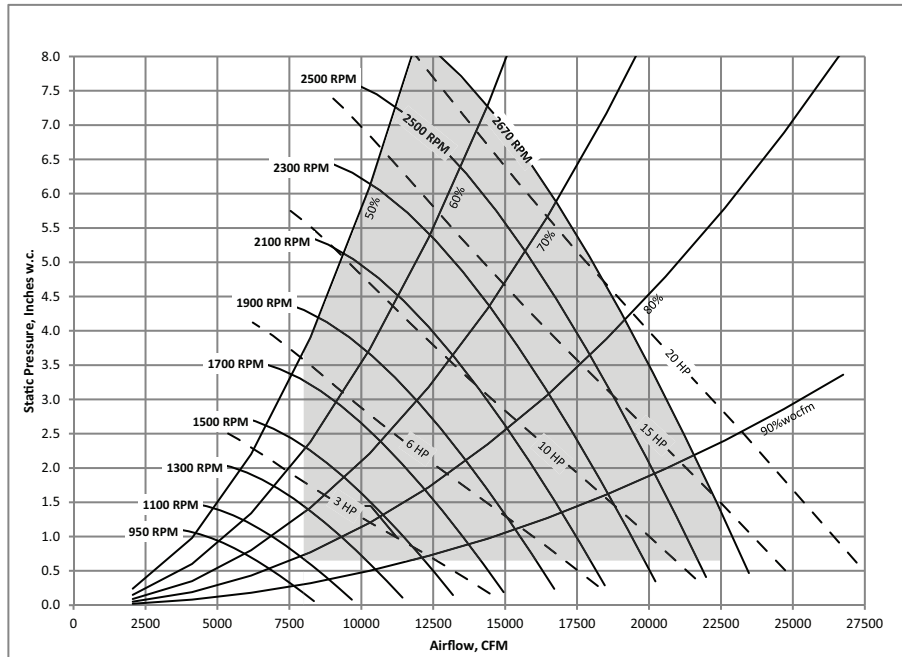
**Note:** Maximum airflow (for cULus approval) as follows: 20 ton - 9000 CFM, 25 ton - 11,250 CFM, 30 ton - 13,500 CFM

**Figure 16. 40, 50 and 55 ton, 18.2 inch - 9 blade - 100% width supply fan**



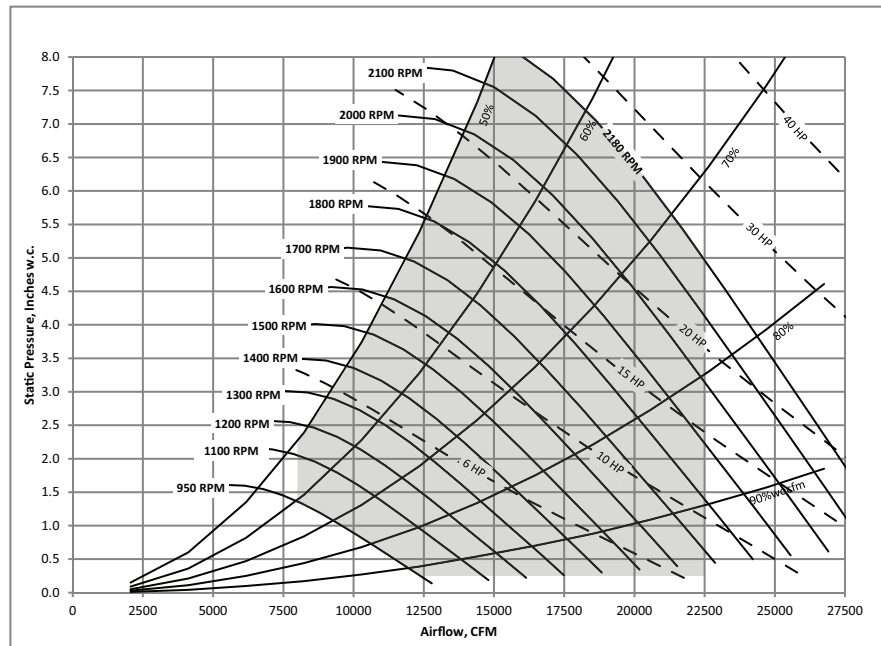
**Note:** Maximum airflow (for cULus approval) as follows: 40 ton - 18,000 CFM, 50/55 ton - 24,750 CFM

**Figure 17. 40, 50 and 55 ton, 20.0 inch - 9 blade - 100% width supply fan**



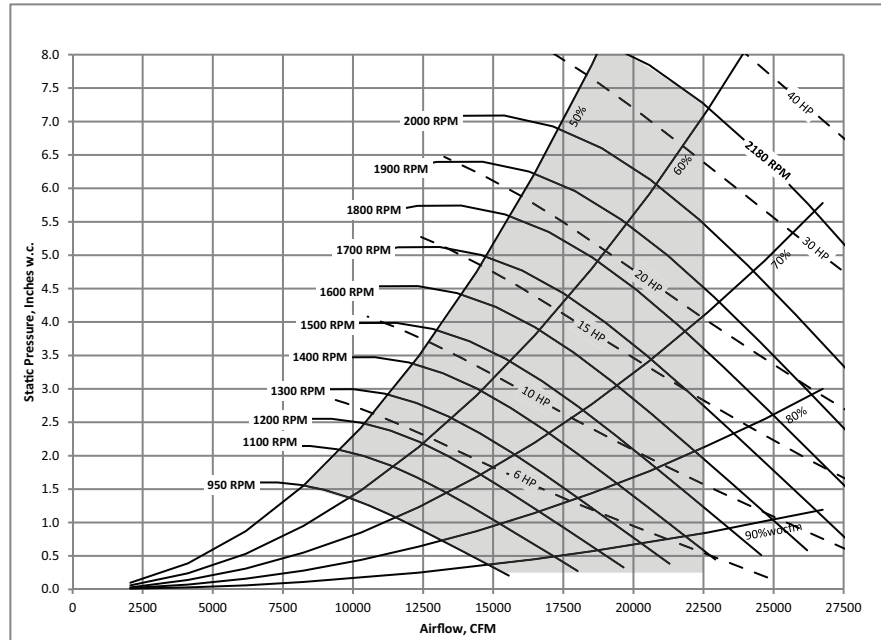
**Note:** Maximum airflow (for cULus approval) as follows: 40 ton - 18,000 CFM, 50/55 ton - 24,750 CFM

**Figure 18. 40, 50 and 55 ton, 24.5 inch - 9 blade - 80% width supply fan**



**Note:** Maximum airflow (for cULus approval) as follows: 40 ton - 18,000 CFM, 50/55 ton - 24,750 CFM

**Figure 19. 40, 50 and 55 ton, 24.5 inch - 9 blade - 100% width supply fan**

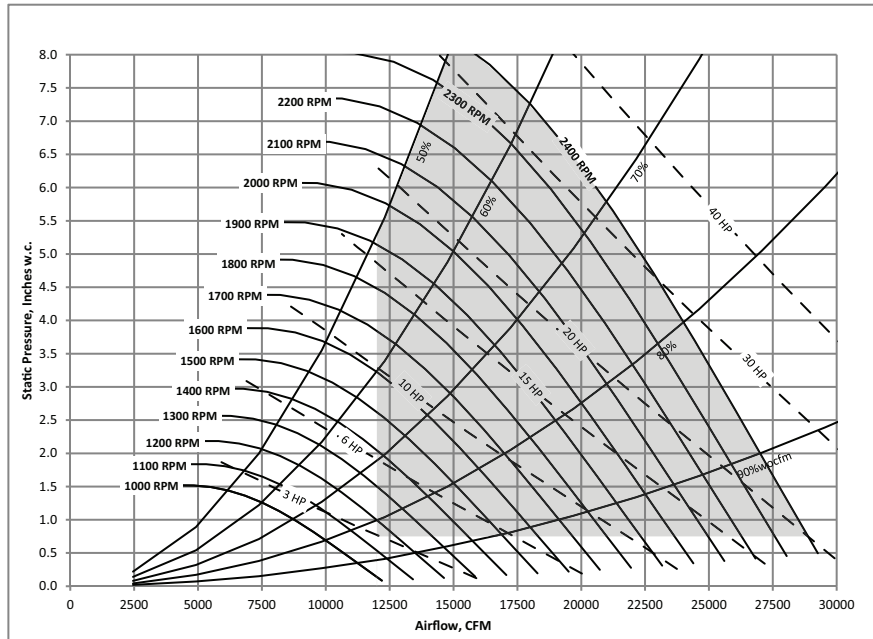


**Note:** Maximum airflow (for cULus approval) as follows: 40 ton - 18,000 CFM, 50/55 ton - 24,750 CFM



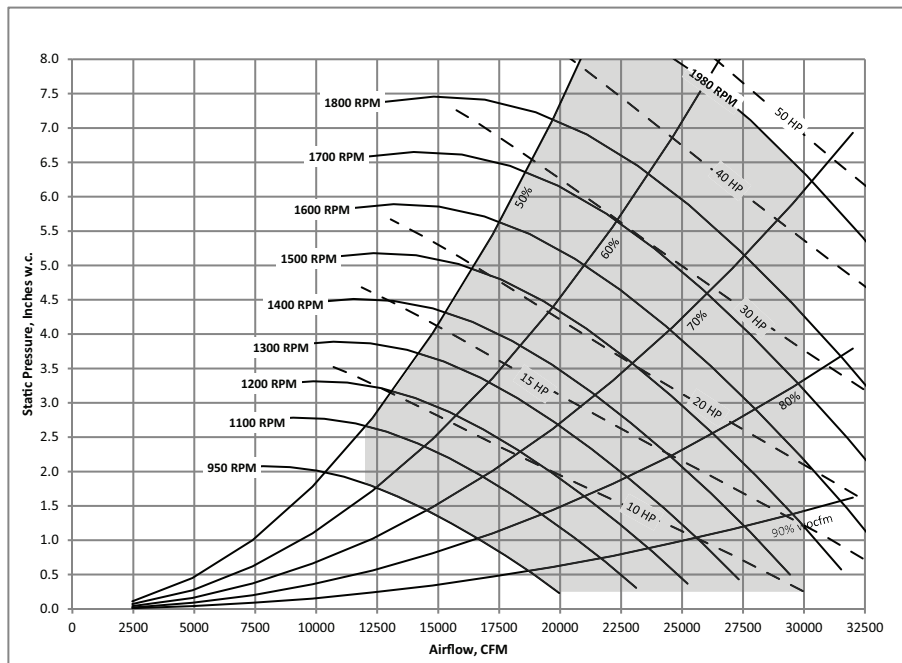
## Performance Data

**Figure 20. 60 and 75 ton, 22.2 inch - 9 blade - 100% width supply fan**



**Note:** Maximum airflow (for cULus approval) as follows: 60 ton - 27,000 CFM, 70/75 ton - 30,000 CFM

**Figure 21. 60 and 75 ton, 27.0 inch - 9 blade - 100% width supply fan**



**Note:** Maximum airflow (for cULus approval) as follows: 60 ton - 27,000 CFM, 70/75 ton - 30,000 CFM

## Relief Fan Curves

Please see notes below for all supply fan curves. For additional information or support, contact your local Trane sales office or Trane representative.

**Important:**

1. Shaded area represents selectable area. Contact your local Trane representative for more information.
2. Relief fan performance curve includes internal resistance of rooftop. To determine total static pressure, add return static pressure and relief damper pressure drop.
3. EC motors are not offered in integral horsepower increments. All fans will be offered with nominal motor power rated to cover the operating envelope of the fan. Power limitation is indicated on fan map.

**Figure 22. 20 to 25 ton, 6 hp relief fan, single fan**

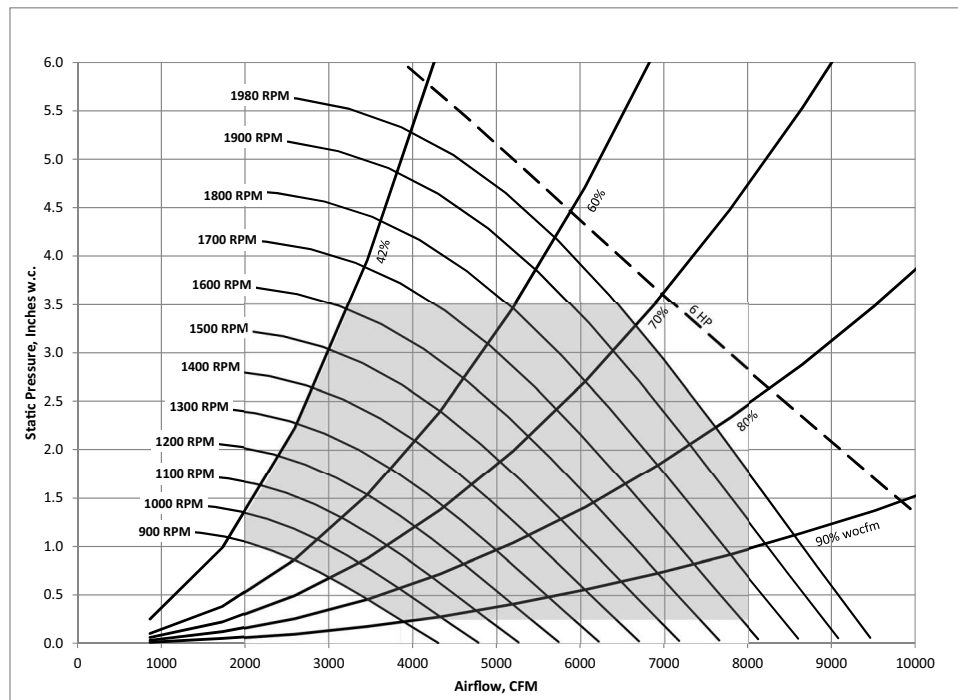


Figure 23. 20 ton, 8 hp relief fan, single fan

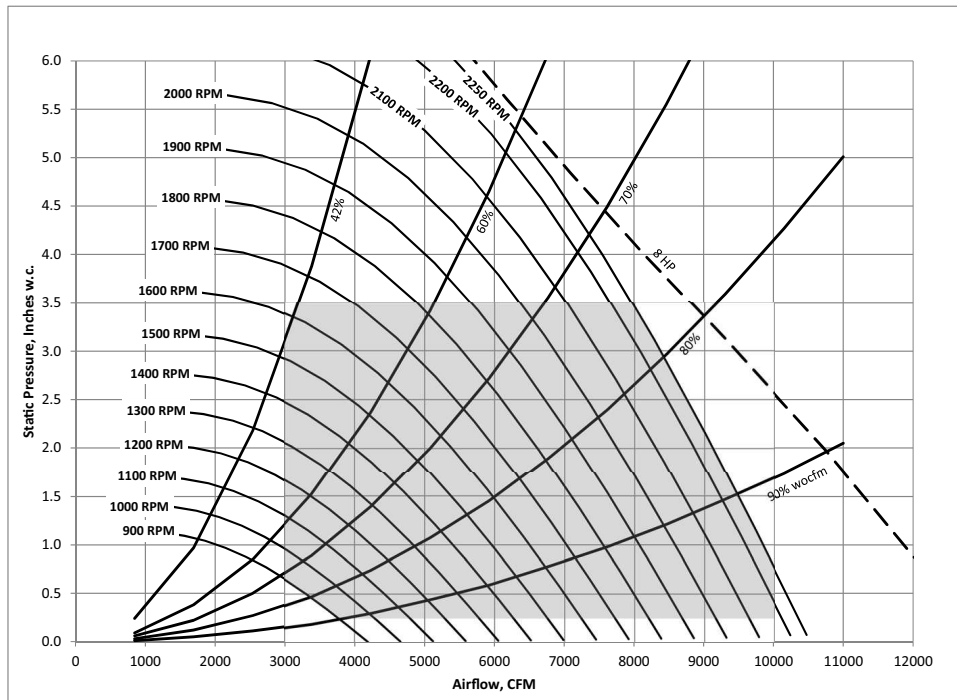
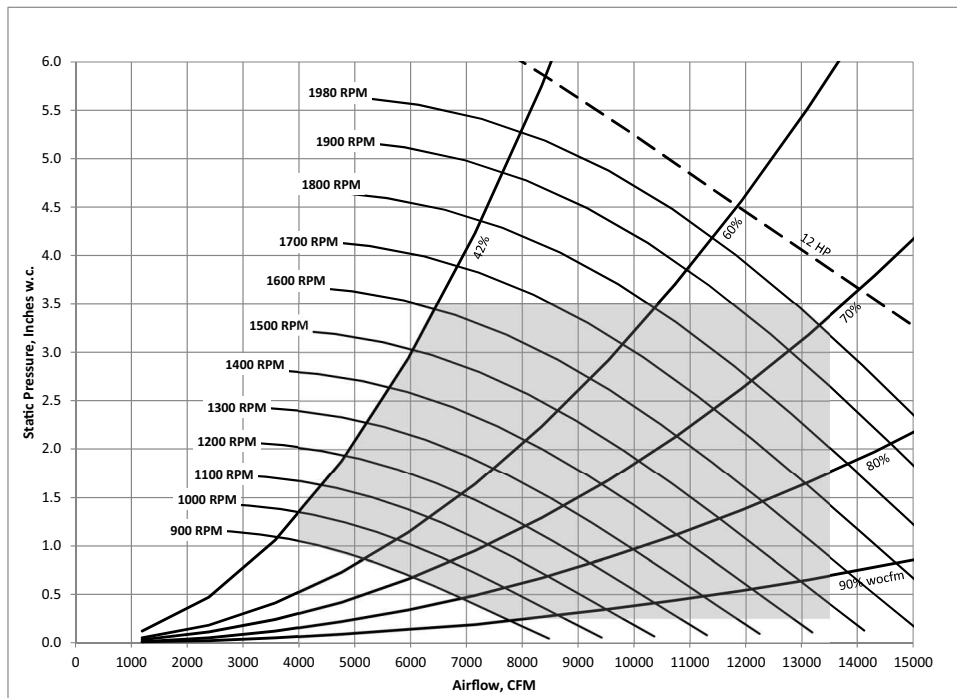
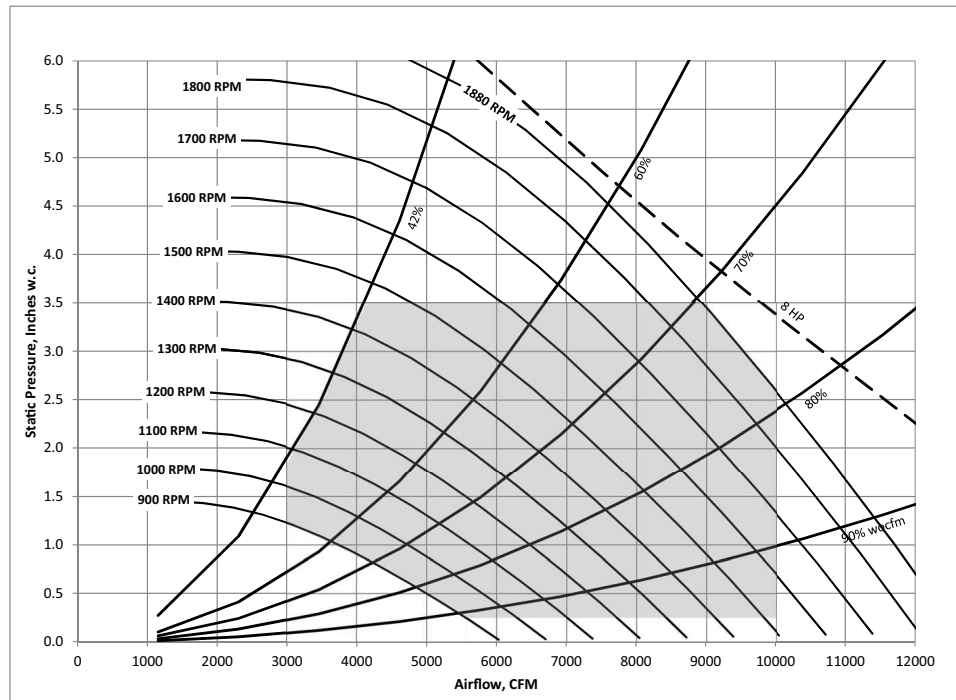


Figure 24. 30 ton, 12 hp relief fan, two-fan array



**Figure 25. 25, 30 and 40 ton, 8 hp relief fan, single fan**



**Figure 26. 40 ton, 15 hp relief fan, two-fan array**

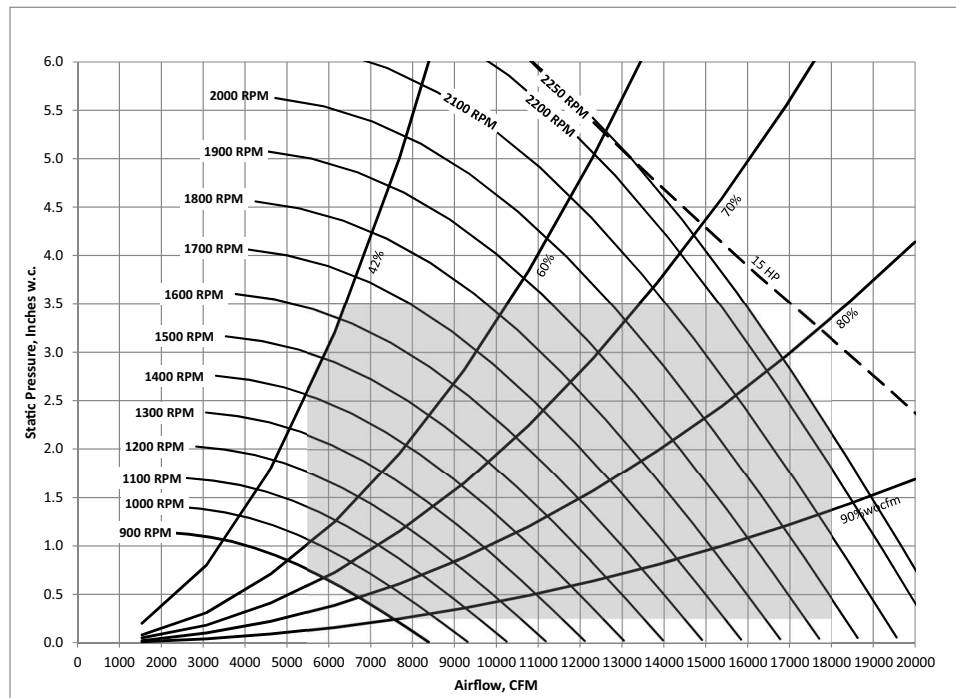


Figure 27. 50 and 55 ton, 12 hp relief fan, two-fan array

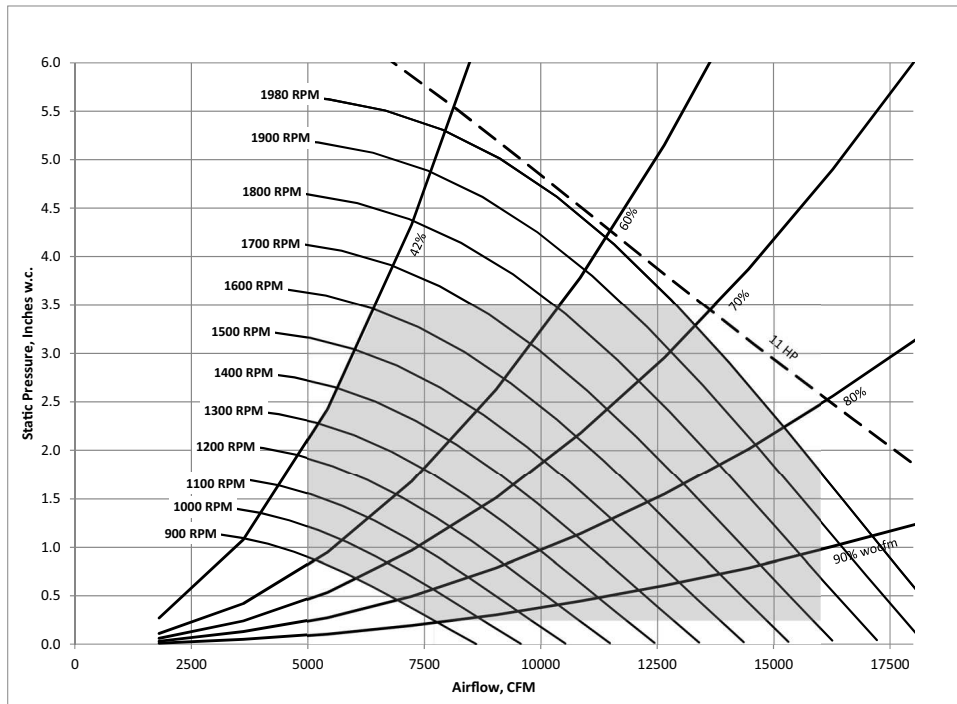
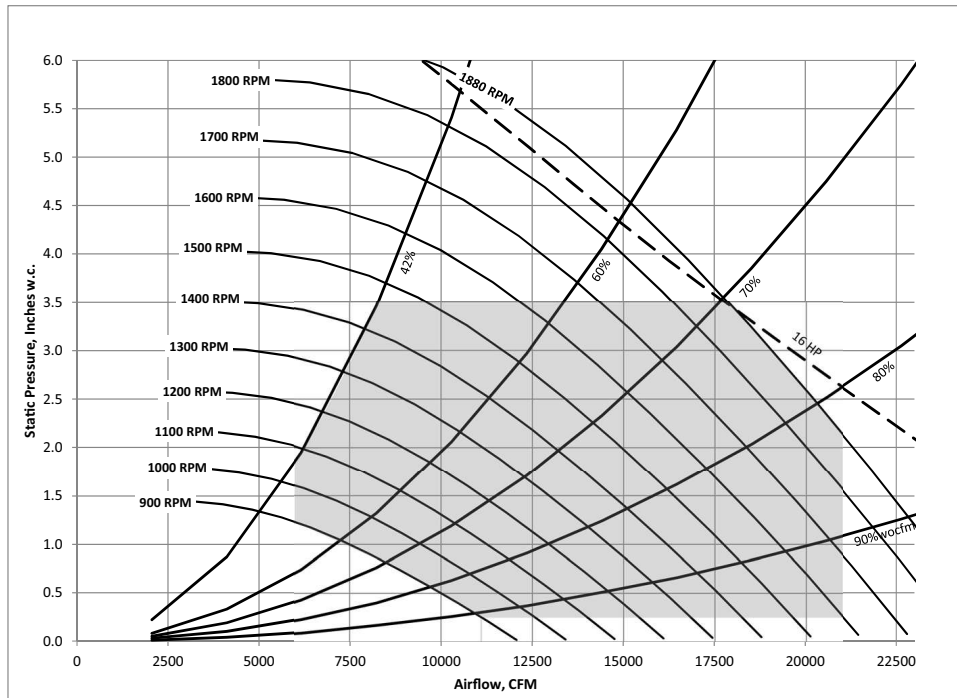
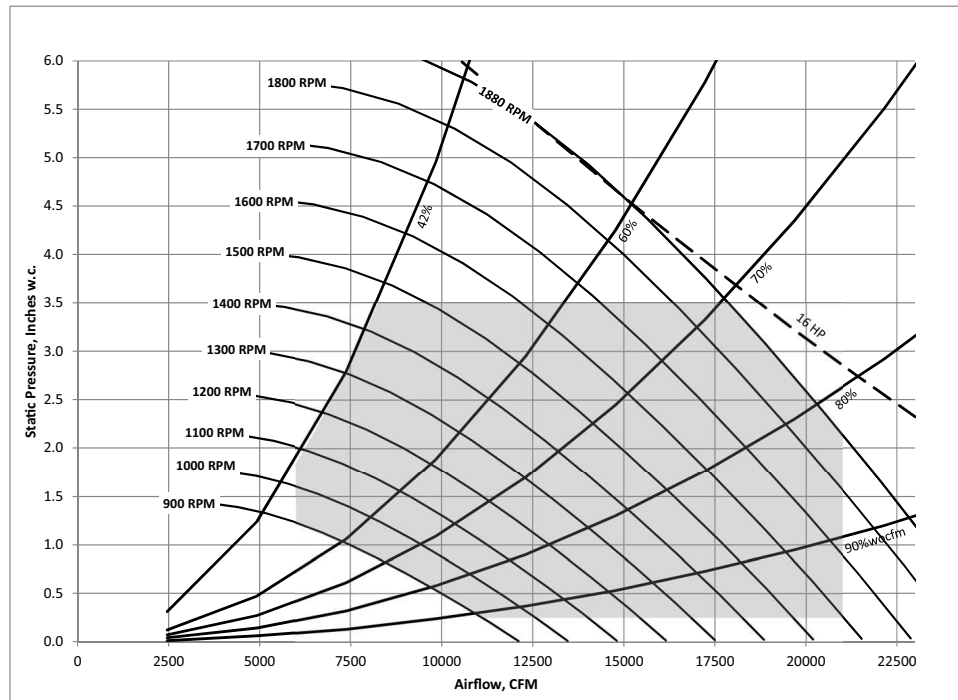


Figure 28. 50 and 55 ton, 16 hp relief fan, two-fan array

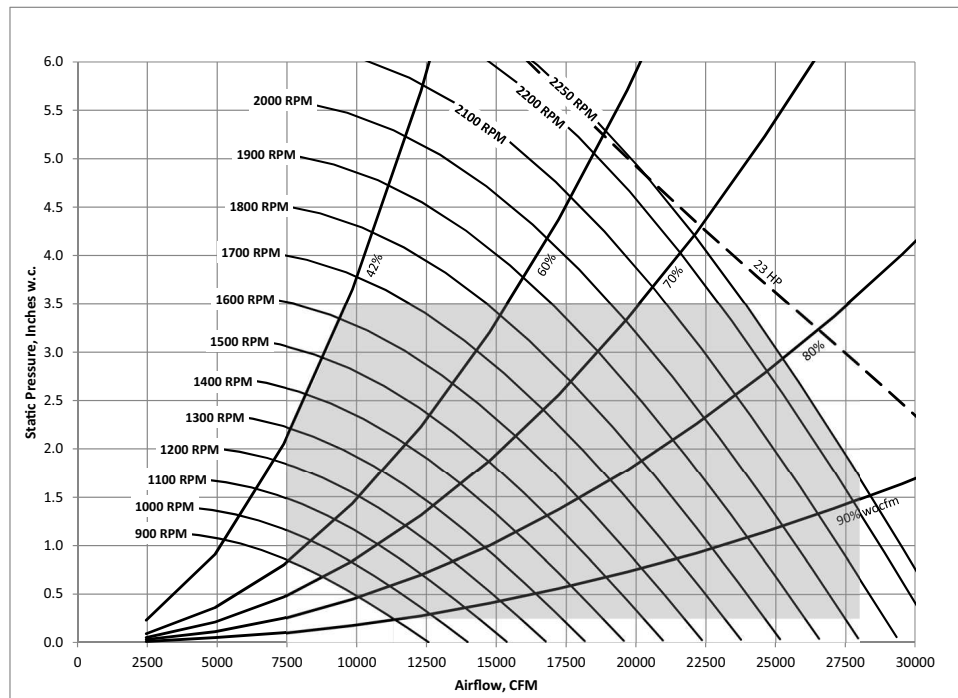




**Figure 29. 60, 70 and 75 ton, 16 hp relief fan, two-fan array**



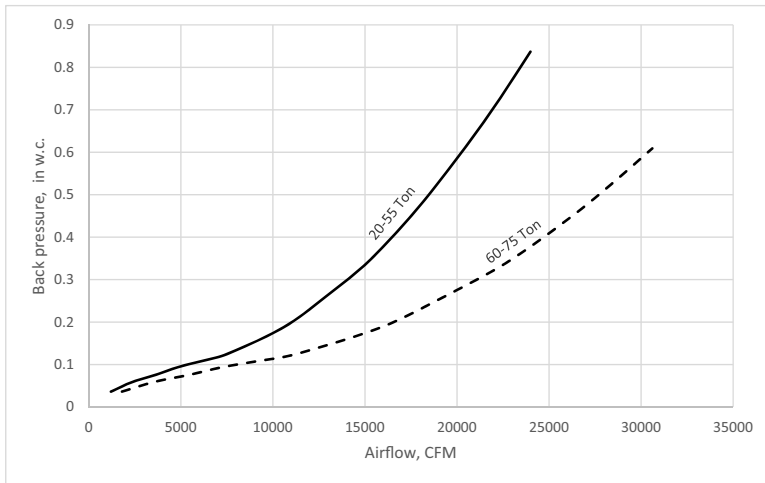
**Figure 30. 60, 70 and 75 ton, 23 hp relief fan, three-fan array**





## Barometric Relief Damper Performance

Figure 31. Barometric Relief Damper Performance



## Component Static Pressure Drops

Table 40. Static pressure drops — relief dampers

Nominal Tons	CFM	Relief Damper Pressure Drop (in w.c.)
20-40 Single Fan	2,000	0.04
	4,000	0.16
	6,000	0.37
	8,000	0.65
	10,000	1.02
30-55 Dual Fan	4,000	0.04
	6,000	0.09
	8,000	0.16
	10,000	0.26
	12,000	0.37
	14,000	0.5
	16,000	0.65
	18,000	0.83
	20,000	1.02
	22,000	1.24
60-75 Dual or Three-Fan Array	6,000	0.07
	8,000	0.12
	10,000	0.19
	12,000	0.27
	14,000	0.37
	16,000	0.48
	18,000	0.61
	20,000	0.75
	22,000	0.91
	24,000	1.08
26,000	1.27	
28,000	1.47	

**Notes:**

1. Relief damper static pressure drop is used only for relief fan selections.
2. Use Relief CFM to determine pressure drop to add to return duct static pressure for relief fan selection.

**Table 41. Component static pressure drops (in. H<sub>2</sub>O)**

Tons	CFM Std	Evap Coil				Heating System				Filters				Economizer					
		Standard Efficiency		Variable		Gas				Electric All kW	Pre Evap Panel				Re-turn Air	Out-side Air W/O Traq	Out-side Air W/Traq		
		Dry Wet	Dry Wet	Dry Wet	Dry Wet	250 MBh	350 MBh	500 MBh	850 MBh		1200 MBh	2" Merv 4	2" Merv 8	4" Merv 8				4" Merv 14	Pre Evap Cart
20	4000	0.06	0.06	0.08	0.08	0.08	0.05	0.04		0.03	0.03	0.05	0.04	0.09	0.08	0.08	0.05	0.03	0.05
	5000	0.08	0.09	0.11	0.12	0.11	0.08	0.06		0.04	0.05	0.07	0.07	0.14	0.12	0.12	0.07	0.05	0.07
	6000	0.10	0.12	0.14	0.16	0.14	0.11	0.09		0.06	0.07	0.10	0.10	0.20	0.18	0.18	0.10	0.08	0.10
	7000	0.12	0.15	0.17	0.20	0.16	0.20	0.12		0.08	0.10	0.14	0.13	0.28	0.24	0.24	0.14	0.10	0.14
	8000	0.14	0.19	0.19	0.25	0.19	0.25	0.16		0.11	0.13	0.18	0.17	0.36	0.32	0.32	0.18	0.13	0.18
25	9000	0.17	0.23	0.23	0.30	0.23	0.30	0.20		0.13	0.17	0.23	0.22	0.46	0.40	0.40	0.23	0.17	0.23
	5000	0.06	0.06	0.11	0.12	0.14	0.15	0.01		0.04	0.05	0.07	0.07	0.14	0.12	0.12	0.07	0.05	0.07
	6250	0.08	0.08	0.15	0.17	0.19	0.21	0.02		0.06	0.08	0.11	0.10	0.22	0.19	0.19	0.11	0.08	0.11
	7500	0.10	0.11	0.19	0.22	0.24	0.28	0.02		0.09	0.12	0.16	0.15	0.32	0.28	0.28	0.16	0.12	0.16
	8750	0.12	0.14	0.22	0.29	0.28	0.36	0.03		0.13	0.16	0.22	0.20	0.44	0.38	0.38	0.22	0.16	0.22
30	10000	0.14	0.18	0.27	0.36	0.34	0.44	0.04		0.17	0.21	0.29	0.27	0.57	0.49	0.49	0.28	0.21	0.29
	11250	0.17	0.22	0.33	0.43	0.42	0.53	0.05		0.21	0.26	0.36	0.34	0.72	0.62	0.62	0.36	0.27	0.36
	6000	0.15	0.00	0.19	0.19	0.18	0.19	0.01		0.06	0.07	0.10	0.10	0.20	0.18	0.18	0.10	0.08	0.10
	7500	0.20	0.00	0.25	0.28	0.25	0.28	0.02		0.09	0.12	0.16	0.15	0.32	0.28	0.28	0.16	0.12	0.16
	9000	0.23	0.00	0.32	0.38	0.31	0.38	0.03		0.13	0.17	0.23	0.22	0.46	0.40	0.40	0.23	0.17	0.23
40	10000	0.30	0.00	0.37	0.48	0.37	0.48	0.04		0.18	0.23	0.32	0.29	0.63	0.54	0.54	0.31	0.23	0.32
	12000	0.37	0.00	0.46	0.60	0.46	0.59	0.05		0.24	0.30	0.41	0.38	0.82	0.71	0.71	0.41	0.30	0.41
	14000	0.48	0.00	0.59	0.75	0.59	0.75	0.07		0.33	0.41	0.56	0.52	1.12	1.02	1.02	0.56	0.41	0.56
	8000	0.14	0.14	0.22	0.24	0.20	0.22	0.02		0.09	0.05	0.08	0.07	0.20	0.16	0.19	0.08	0.22	0.27
	10000	0.19	0.20	0.30	0.34	0.31	0.34	0.02		0.14	0.08	0.13	0.12	0.31	0.26	0.29	0.13	0.34	0.43
50	12500	0.23	0.27	0.36	0.46	0.45	0.49	0.03		0.20	0.11	0.19	0.17	0.45	0.37	0.42	0.19	0.49	0.62
	14000	0.27	0.35	0.45	0.58	0.61	0.67	0.05		0.28	0.15	0.25	0.23	0.62	0.51	0.57	0.26	0.66	0.84
	16000	0.34	0.43	0.56	0.72	0.79	0.87	0.06		0.36	0.20	0.33	0.30	0.80	0.66	0.74	0.34	0.86	1.10
	18000	0.41	0.53	0.68	0.85	1.00	1.10	0.08		0.46	0.25	0.42	0.37	1.02	0.84	0.94	0.43	1.09	1.39
	10000	0.25	0.27	0.38	0.41	0.31	0.34	0.02		0.14	0.08	0.13	0.12	0.31	0.26	0.29	0.13	0.34	0.43
55	12500	0.34	0.39	0.50	0.58	0.42	0.48	0.04		0.22	0.12	0.20	0.18	0.49	0.40	0.45	0.21	0.53	0.67
	15000	0.41	0.52	0.60	0.78	0.52	0.65	0.05		0.32	0.17	0.29	0.26	0.71	0.58	0.65	0.30	0.76	0.96
	17500	0.52	0.67	0.77	1.00	0.65	0.83	0.07		0.43	0.23	0.40	0.35	0.96	0.79	0.89	0.41	1.03	1.31
	20000	0.64	0.83	0.96	1.22	0.80	1.02	0.09		0.57	0.31	0.52	0.46	1.26	1.03	1.16	0.53	1.35	1.71
	22500	0.78	0.99	1.17	1.46	0.98	1.22	0.12		0.72	0.39	0.65	0.59	1.59	1.31	1.47	0.67	1.71	2.17
60	11000	0.36	0.39	0.43	0.47	0.36	0.39	0.03		0.17	0.09	0.16	0.14	0.38	0.31	0.35	0.16	0.41	0.52
	13750	0.49	0.57	0.57	0.68	0.47	0.57	0.04		0.27	0.14	0.24	0.22	0.59	0.49	0.55	0.25	0.64	0.81
	16500	0.59	0.76	0.70	0.91	0.59	0.76	0.06		0.39	0.21	0.35	0.31	0.86	0.70	0.79	0.36	0.92	1.17
	19250	0.75	0.96	0.91	1.16	0.75	0.97	0.09		0.52	0.28	0.48	0.43	1.16	0.96	1.08	0.49	1.25	1.59
	22000	0.94	1.18	1.13	1.42	0.94	1.19	0.11		0.68	0.37	0.63	0.56	1.52	1.25	1.41	0.64	1.63	2.07
24750	1.14	1.40	1.37	1.69	1.14	1.41	0.14		0.87	0.47	0.79	0.71	1.93	1.58	1.78	0.81	2.07	2.62	
12000	0.17	0.18	0.34	0.36	0.33	0.36	0.03		0.17	0.05	0.09	0.08	0.24	0.22	0.25	0.14	0.37	0.46	
15000	0.23	0.26	0.45	0.51	0.44	0.51	0.05		0.26	0.08	0.14	0.13	0.38	0.34	0.38	0.22	0.57	0.72	
18000	0.29	0.34	0.53	0.69	0.56	0.69	0.07		0.38	0.11	0.21	0.18	0.55	0.49	0.55	0.32	0.82	1.04	
21000	0.34	0.44	0.68	0.88	0.68	0.88	0.09		0.52	0.15	0.28	0.25	0.74	0.66	0.75	0.44	1.12	1.42	
24000	0.43	0.55	0.85	1.07	0.85	1.07	0.12		0.68	0.20	0.37	0.33	0.97	0.87	0.98	0.57	1.46	1.85	
27000	0.52	0.66	1.03	1.28	1.03	1.27	0.15		0.86	0.25	0.47	0.41	1.23	1.10	1.24	0.73	1.85	2.34	

Table 41. Component static pressure drops (in. H<sub>2</sub>O) (continued)

Tons	CFM Std	Evap Coil				HGRH	Heating System				Filters				Economizer					
		Standard Efficiency		Variable			Gas		Electric		Pre Evap Panel		Pre Evap Cart	Final Cart	Re-turn Air	Out-side Air W/O Traq	Out-side Air W/Traq			
		Dry	Wet	Dry	Wet		250 MBh	350 MBh	500 MBh	850 MBh	1200 MBh	All kW						2" Merv 4	2" Merv 8	4" Merv 8
70	14000	0.35	0.38	0.21	0.24	0.03		0.48	0.61	0.55	0.23	0.07	0.13	0.11	0.33	0.29	0.33	0.20	0.50	0.63
	17200	0.46	0.53	0.27	0.33	0.04		0.73	0.92	0.82	0.35	0.10	0.19	0.17	0.50	0.45	0.50	0.29	0.75	0.95
	20400	0.54	1.44	0.30	0.43	0.05		1.03	1.30	1.16	0.49	0.14	0.27	0.24	0.70	0.63	0.71	0.41	1.06	1.34
	23600	0.69	0.88	0.38	0.54	0.07		1.37	1.74	1.55	0.65	0.19	0.36	0.32	0.94	0.84	0.95	0.55	1.41	1.79
	26800	0.85	1.07	0.48	0.66	0.09		1.77	2.24	2.00	0.84	0.25	0.46	0.41	1.21	1.08	1.22	0.72	1.82	2.31
75	30000	1.02	1.26	0.57	0.78	0.12		2.22	2.81	2.50	1.06	0.31	0.58	0.51	1.52	1.35	1.53	0.90	2.28	2.89
	15000	0.47	0.51	0.24	0.26	0.03		0.56	0.70	0.63	0.26	0.08	0.14	0.13	0.38	0.34	0.38	0.22	0.57	0.72
	18000	0.58	0.00	0.29	0.35	0.04		0.80	1.01	0.90	0.38	0.11	0.21	0.18	0.55	0.49	0.55	0.32	0.82	1.04
	21000	0.68	0.88	0.32	0.45	0.06		1.09	1.38	1.23	0.52	0.15	0.28	0.25	0.74	0.66	0.75	0.44	1.12	1.42
	24000	0.85	1.08	0.39	0.55	0.08		1.42	1.80	1.60	0.68	0.20	0.37	0.33	0.97	0.87	0.98	0.57	1.46	1.85
Notes:	27000	1.03	1.29	0.48	0.67	0.10		1.80	2.28	2.03	0.86	0.25	0.47	0.41	1.23	1.10	1.24	0.73	1.85	2.34
	30000	1.22	1.51	0.57	0.79	0.12		2.22	2.81	2.50	1.06	0.31	0.58	0.51	1.52	1.35	1.53	0.90	2.28	2.89

- Notes:
1. Static pressure drops of accessory components must be added to determine total static pressure for fan selections.
  2. Gas heat section maximum temperature rise of 60°F.
  3. Economizer static pressure value for sizing supply fan is the highest of the following: a) Return air static pressure drop plus customer return duct static pressure and b) Outside air static pressure drop.



# Electrical Data

## Electrical Service Sizing

To correctly size electrical service wiring for a unit, find the appropriate calculations listed below. Each type of unit has its own set of calculations for MCA (Minimum Circuit Ampacity) and MOP (Maximum Overcurrent Protection). Read the load definitions that follow and then find the appropriate set of calculations based on unit type.

**Note:** Set 1 is for cooling only and cooling with gas heat units, and set 2 is for cooling with electric heat units.

Load Definitions: (To determine load values, see the Electrical Service Sizing Data Tables on the following page.)

Load Definitions	
LOAD 1	Current of the largest motor (compressor or fan motor)
LOAD 2	Sum of the currents of all remaining motors
LOAD 3	Current of electric heaters
LOAD 4	Any other load rated at 1 amp or more

### Set 1: Cooling Only Rooftop Units and Cooling with Gas Heat Rooftop Units

$$\text{MCA} = (1.25 \times \text{LOAD1}) + \text{LOAD2} + \text{LOAD4}$$

$$\text{MOP} = (2.25 \times \text{LOAD1}) + \text{LOAD2} + \text{LOAD4}$$

Select a fuse rating equal to the MOP value. If the MOP value does not equal a standard fuse size as listed in NEC 240-6, select the next lower standard fuse rating.

**Note:** If selected MOP is less than the MCA, then select the lowest standard maximum fuse size which is equal to or larger than the MCA, provided the selected fuse size does not exceed 800 amps.

### Set 2: Rooftop units with Electric Heat

#### Single Source Power units (460V and 575V)

To arrive at the correct MCA and MOP values for these units, two sets of calculations must be performed. First calculate the MCA and MOP values as if the unit was in cooling mode (use the equations given in Set 1). Then calculate the MCA and MOP values as if the unit were in heating mode as follows. (Keep in mind when determining LOADS that the compressors and condenser fan motors don't run while the unit is in heating mode).

For units using heaters less than 50 kW:

$$\text{MCA} = 1.25 \times (\text{LOAD1} + \text{LOAD2} + \text{LOAD4}) + (1.25 \times \text{LOAD3})$$

For units using heaters equal to or greater than 50 kW:

$$\text{MCA} = 1.25 \times (\text{LOAD1} + \text{LOAD2} + \text{LOAD4}) + (1.0 \times \text{LOAD3})$$

The nameplate MCA value will be the larger of the cooling mode MCA value or the heating mode MCA value calculated above.

$$\text{MOP} = (2.25 \times \text{LOAD1}) + \text{LOAD2} + \text{LOAD3} + \text{LOAD4}$$

The selection MOP value will be the larger of the cooling mode MOP value or the heating mode MOP value calculated above.

Select a fuse rating equal to the MOP value. If the MOP value does not equal a standard fuse size as listed in NEC 240-6, select the next lower standard fuse rating. If the selected MOP value is less than 125 percent of the current rating of the electric heat load, select the next higher standard fuse rating.

**Note:** If selected MOP is less than the MCA, then select the lowest standard maximum fuse size which is equal to or larger than the MCA, provided the selected fuse size does not exceed 800 amps.



**Dual Source Power units (200V and 230V)**

These units will have two circuit values shown on the nameplate. The first circuit value will be the refrigeration (cooling mode) values calculated per Set 1. The second set of circuit values shown on the nameplate will be for the electric heating circuit as follows.

For units using heaters less than 50 kW:

$$\text{MCA} = (1.25 \times \text{LOAD3})$$

For units using heaters equal to or greater than 50 kW:

$$\text{MCA} = (1.0 \times \text{LOAD3})$$

$$\text{MOP} = (1.25 \times \text{LOAD3})$$

Select a fuse rating for the electric heating circuit that is equal to the MOP value obtained in the equation above. If the MOP value does not equal a standard fuse size as listed in NEC 240-6, select the next lower standard fuse rating (see note below for exception). If the selected MOP value is less than 125 percent of the current rating of the electric heat load, select the next higher standard fuse rating.

**Note:** *If the available MOP option is less than the MCA obtained in the equation above, then reselect the lowest standard maximum fuse size which is equal to, or larger, than the MCA, provided the reselected fuse size does not exceed 800 amps.*

## Service Sizing Data

**Table 42. Compressor electrical service sizing data (20 to 75 ton)**

Tons	No. of Compressors	200 V		230 V		460 V		575 V	
		RLA (ea.)	LRA (ea.)	RLA (ea.)	LRA (ea.)	RLA (ea.)	LRA (ea.)	RLA (ea.)	LRA (ea.)
20 Std	1	19.1	180.0	19.1	180.0	9.2	75.0	7.3	60.0
	2	28.4	208.0	28.4	208.0	11.9	98.0	9.9	75.0
20 Hi Eff	1	40.3	267.0	40.3	267.0	19.1	142.0	15.8	103.0
	1	45.6	304.0	42.3	304.0	19.8	147.0	17.2	122.0
20 Vari Spd	1 <sup>(a)</sup>	38.7	NA	33.5	NA	17.5	NA	15.4	NA
	1	35.5	267.0	30.8	267.0	15.3	142.0	15.2	103.0
25 Std	1	27.7	203.0	27.0	203.0	14.5	98.0	12.5	84.0
	2	35.5	267.0	30.8	267.0	15.3	142.0	15.2	103.0
25 Hi Eff	1	45.6	304.0	42.3	304.0	19.8	147.0	17.2	122.0
	1	51.4	315.0	45.6	315.0	22.7	158.0	19.1	136.0
25 Vari Spd	1 <sup>(a)</sup>	46.4	NA	40.2	NA	20.1	NA	16.9	NA
	1	40.3	267.0	40.3	267.0	19.1	142.0	15.8	103.0
30 Std	1	27.7	203.0	27.0	203.0	14.5	98.0	12.5	84.0
	2	40.3	267.0	40.3	267.0	19.1	142.0	15.8	103.0
30 Hi Eff	1	51.4	315.0	45.6	315.0	22.7	158.0	19.1	136.0
	1	60.5	345.0	52.4	345.0	26.2	155.0	23.1	126.0
30 Vari Spd	1 <sup>(a)</sup>	52.9	NA	45.9	NA	23.0	NA	19.3	NA
	1	51.4	315.0	45.6	315.0	22.7	158.0	19.1	136.0
40 Std	4	35.5	267.0	30.8	267.0	15.3	142.0	15.2	103.0
40 Hi Eff	4	35.5	267.0	30.8	267.0	15.3	142.0	15.2	103.0
40 Vari Spd	1 <sup>(a)</sup>	55.4	NA	48.0	NA	24.0	NA	20.2	NA
	2	35.5	267.0	30.8	267.0	15.3	142.0	15.2	103.0
50 Std	2	40.3	267.0	40.3	267.0	19.1	142.0	15.8	103.0
	2	45.6	304.0	42.3	304.0	19.8	147.0	17.2	122.0
50 Hi Eff	2	40.3	267.0	40.3	267.0	19.1	142.0	15.8	103.0
	2	45.6	304.0	42.3	304.0	19.8	147.0	17.2	122.0
50 Vari Spd	1 <sup>(a)</sup>	74.8	NA	63.6	NA	32.5	NA	27.3	NA
	2	45.6	304.0	42.3	304.0	19.8	147.0	17.2	122.0
55 Std	4	45.6	304.0	42.3	304.0	19.8	147.0	17.2	122.0
55 Hi Eff	2	40.3	267.0	40.3	267.0	19.1	142.0	15.8	103.0
	2	45.6	304.0	42.3	304.0	19.8	147.0	17.2	122.0
55 Vari Spd	1 <sup>(a)</sup>	74.8	NA	63.6	NA	32.5	NA	27.3	NA
	2	45.6	304.0	42.3	304.0	19.8	147.0	17.2	122.0
60 Std	2	51.4	315.0	45.6	315.0	22.7	158.0	19.1	136.0
	2	60.5	345.0	52.4	345.0	26.2	155.0	23.1	126.0
60 Hi Eff	4	51.4	315.0	45.6	315.0	22.7	158.0	19.1	136.0
60 Vari Spd	1 <sup>(a)</sup>	76.4	NA	64.3	NA	35.9	NA	29.4	NA
	2	60.5	345.0	52.4	345.0	26.2	155.0	23.1	126.0
70 Std	4	60.5	345.0	52.4	345.0	26.2	155.0	23.1	126.0
70 Hi Eff	2	51.4	315.0	45.6	315.0	22.7	158.0	19.1	136.0
	2	60.5	345.0	52.4	345.0	26.2	155.0	23.1	126.0
70 Vari Spd	1 <sup>(a)</sup>	84.2	NA	73.0	NA	36.5	NA	30.6	NA
	2	60.5	345.0	52.4	345.0	26.2	155.0	23.1	126.0
75 Std	4	60.5	345.0	52.4	345.0	26.2	155.0	23.1	126.0
75 Hi Eff	4	60.5	345.0	52.4	345.0	26.2	155.0	23.1	126.0
75 Vari Spd	1 <sup>(a)</sup>	74.8	NA	63.6	NA	32.5	NA	27.3	NA
	1	60.1	320.0	51.5	320.0	26.0	160.0	21.9	135.0
	2	51.4	315.0	45.6	315.0	22.7	158.0	19.1	136.0

<sup>(a)</sup> Variable Speed Compressor



## Electrical Data

**Table 43. Condenser fan electrical service sizing data (20-75 ton)**

Tonnage	No. of Motors	200 V	230 V	460 V	575 V
		FLA (ea.)	FLA (ea.)	FLA (ea.)	FLA (ea.)
20 Std	2	5.4	5.4	2.7	2.2
20 Low Ambient	1 <sup>(a)</sup>	5.6	5.6	2.9	2.4
	1	5.4	5.4	2.7	2.2
25 Std	2	5.4	5.4	2.7	2.2
25 Low Ambient	1 <sup>(a)</sup>	5.6	5.6	2.9	2.4
	1	5.4	5.4	2.7	2.2
30 Std	2	5.4	5.4	2.7	2.2
30 Low Ambient	1 <sup>(a)</sup>	5.6	5.6	2.9	2.4
	1	5.4	5.4	2.7	2.2
40 Std	4	5.4	5.4	2.7	2.2
40 Low Ambient	2 <sup>(a)</sup>	5.6	5.6	2.9	2.4
	2	5.4	5.4	2.7	2.2
50 Std	4	5.4	5.4	2.7	2.2
50 Low Ambient	2 <sup>(a)</sup>	5.6	5.6	2.9	2.4
	2	5.4	5.4	2.7	2.2
55 Std	4	5.4	5.4	2.7	2.2
55 Low Ambient	2 <sup>(a)</sup>	5.6	5.6	2.9	2.4
	2	5.4	5.4	2.7	2.2
60 Std	6	4.1	4.1	1.8	1.4
60 Low Ambient	2 <sup>(a)</sup>	5.6	5.6	2.9	2.4
	4	4.1	4.1	1.8	1.4
70 Std	6	4.1	4.1	1.8	1.4
70 Low Ambient	2 <sup>(a)</sup>	5.6	5.6	2.9	2.4
	4	4.1	4.1	1.8	1.4
75 Std	6	4.1	4.1	1.8	1.4
75 Low Ambient	2 <sup>(a)</sup>	5.6	5.6	2.9	2.4
	4	4.1	4.1	1.8	1.4

<sup>(a)</sup> Variable Speed Fan

**Table 44. Electrical service sizing data —electric heat module (electric heat units only) — 20 to 75 tons**

Module kW	Voltage (Amps)			
	200 V	230 V	460 V	575 V
30	62.5	72.2	36.1	28.9
60	124.9	144.3	72.2	57.7
90	187.4	216.5	108.3	86.6
120	233.2	269.4	144.3	115.5
150	NA	NA	180.4	144.3
190	NA	NA	224.9	182.8

**Note:** Electric heat FLA are determined at 208, 240, 480 and 600 volts.



**Table 45. Electrical service sizing data – Supply fan motors – 20 to 75 tons**

	200 V	230 V	460 V	575 V
	FLA (ea.)	FLA (ea.)	FLA (ea.)	FLA (ea.)
<b>Motor Horsepower</b>	<b>Supply Fan Motor (4 pole) with VFD Bypass</b>			
1.5	5.6	5.6	3.5	3.7
3	14.1	14.1	4.7	3.7
5	21.0	14.1	8.3	5.3
7.5	41.0	21.0	11.2	8.7
10	41.0	41.0	15.1	11.9
15	41.0	41.0	22.1	16.5
20	56.1	52.7	29.9	22.5
25	70.1	65.0	32.2	27.0
<b>Motor Horsepower</b>	<b>Supply Fan Motor (6 pole) with VFD Bypass</b>			
1.5	6.1	5.6	3.5	3.7
3	14.1	14.1	4.7	3.7
5	21.0	14.8	8.3	5.6
7.5	41.0	22.0	11.2	11.9
10	41.0	41.0	22.1	16.5
15	52.7	41.0	22.1	16.5
20	65.0	54.0	29.9	27.0
<b>Motor Horsepower</b>	<b>Supply Fan Motor (4 pole) with out VFD Bypass</b>			
1.5	5.6	5.6	3.5	3.7
3	14.1	14.1	4.7	3.7
5	21.0	14.1	8.3	5.0
7.5	41.0	21.0	11.2	8.7
10	41.0	41.0	15.1	11.9
15	52.7	41.0	22.1	16.5
20	52.7	52.7	29.9	22.5
25	65.0	65.0	35.2	27.0
<b>Motor Horsepower</b>	<b>Supply Fan Motor (6 pole) with out VFD Bypass</b>			
1.5	5.6	5.6	3.5	3.7
3	14.1	14.1	4.7	3.7
5	21.0	14.1	8.3	5.0
7.5	41.0	21.0	11.2	11.9
10	41.0	41.0	22.1	16.5
15	52.7	41.0	22.1	16.5
20	52.7	52.7	29.9	27.0

**Notes:**

1. FLA is for individual motors by HP, not total unit supply and relief fan HP
2. Supply fans selected under 1,600 RPM will have 6-pole motors

**Table 46. Electrical service sizing data – Relief fan motors – 20 to 75 tons**

Tonnage	HP (Total)	No. of Motors	200 V	230 V	460 V	575 V
			FLA (ea.)	FLA (ea.)	FLA (ea.)	FLA (ea.)
20	6	1	12.8	12.8	6.3	N/A
20	8 <sup>(a)</sup>	1	19.5	19.5	9.0	N/A
25	6	1	12.8	12.8	6.3	N/A
25	8 <sup>(b)</sup>	1	18.2	18.2	9.3	N/A
30	8 <sup>(b)</sup>	1	18.2	18.2	9.3	N/A
30	12	2	12.8	12.8	6.3	N/A
40	8 <sup>(b)</sup>	1	18.2	18.2	9.3	N/A
40	15 <sup>(a)</sup>	2	19.5	19.5	9.0	N/A
50	12	2	12.8	12.8	6.3	N/A
50	16 <sup>(b)</sup>	2	18.2	18.2	9.3	N/A
55	12	2	12.8	12.8	6.3	N/A
55	16 <sup>(b)</sup>	2	18.2	18.2	9.3	N/A
60	16 <sup>(b)</sup>	2	18.2	18.2	9.3	N/A
60	23 <sup>(a)</sup>	3	19.5	19.5	9.0	N/A
70	16 <sup>(b)</sup>	2	18.2	18.2	9.3	N/A
70	23 <sup>(a)</sup>	3	19.5	19.5	9.0	N/A
75	16 <sup>(b)</sup>	2	18.2	18.2	9.3	N/A
75	23 <sup>(a)</sup>	3	19.5	19.5	9.0	N/A

- (a) 23" fan diameter
- (b) 25.5" fan diameter



## Electrical Data

**Table 47. Electrical service sizing data (amps) - control power transformer heating and cooling modes - 20 to 75 tons**

Nom Tons	Digit 2 Unit Function	Voltage			
		200	230	460	575
		FLA	FLA	FLA	FLA
All	All	10	10	4.5	3.5

**Table 48. Voltage utilization range**

Unit Voltage	Voltage Utilization Range
200/60/3	180-220
230/60/3	207-253
460/60/3	414-506
575/60/3 (WYE)	517-633



# Dimensional Data

Table 49. Unit Dimensions

Tons	Refrigeration System Performance		Unit Function		Relief Option		Outside Air		Pre-Evaporator Coil Filter		Overall Length (in.)	Foot-print Length (in.)	H (in)	W (in)
	Type	Digit 9	Type	Digit 2	Type	Digit 18	Type	Digit 27	Type	Digit 24				
20-30	All	1,2,3	No Heat	A	Relief Fan	2	Yes	1,2,3,4	Panel	A,B,C,D,F,G	220.88	213.00	81.59	90.63
					Cartridge	E,H	239.86	232.00						
					Panel	A,B,C,D,F,G	220.85	182.01						
					Cartridge	E,H	239.95	201.01						
					Panel	A,B,C,D,F,G	182.01	182.01						
					Cartridge	E,H	201.01	201.01						
	All	1,2,3	Electric Heat, Gas Heat, No Heat - Extended Casing	EFX	Relief Fan	2	Yes	1,2,3,4	Panel	A,B,C,D,F,G	270.61	262.72		
					Cartridge	E,H	289.58	281.72						
					Panel	A,B,C,D,F,G	270.61	231.74						
					Cartridge	E,H	289.68	250.74						
					Panel	A,B,C,D,F,G	231.74	231.74						
					Cartridge	E,H	250.74	250.74						
40-55	All	1,2,3	No Heat	A	Relief Fan	2	Yes	1,2,3,4	Panel	A,B,C,D,F,G	268.56	260.64	81.59	90.63
					Cartridge	E,H	268.56	279.64						
					Panel	A,B,C,D,F,G	268.56	229.66						
					Cartridge	E,H	287.56	248.66						
					Panel	A,B,C,D,F,G	229.66	229.66						
					Cartridge	E,H	248.66	248.66						
	All	1,2,3	Electric Heat, Gas Heat, No Heat - Extended Casing	EFX	Relief Fan	2	Yes	1,2,3,4	Panel	A,B,C,D,F,G	320.79	312.87		
					Cartridge	E,H	339.79	331.87						
					Panel	A,B,C,D,F,G	320.79	281.88						
					Cartridge	E,H	339.79	300.88						
					Panel	A,B,C,D,F,G	281.88	281.88						
					Cartridge	E,H	300.88	300.88						
60	All	1,2,3	No Heat	A	Relief Fan	2	Yes	1,2,3,4	Panel	A,B,C,D,F,G	268.50	266.15	81.59	116.13
					Cartridge	E,H	287.50	285.15						
					Panel	A,B,C,D,F,G	268.50	229.66						
					Cartridge	E,H	287.50	248.66						
					Panel	A,B,C,D,F,G	229.66	229.66						
					Cartridge	E,H	248.66	248.66						
	All	1,2,3	Electric Heat, Gas Heat, No Heat - Extended Casing	EFX	Relief Fan	2	Yes	1,2,3,4	Panel	A,B,C,D,F,G	320.73	318.37		
					Cartridge	E,H	339.73	337.37						
					Panel	A,B,C,D,F,G	320.73	281.88						
					Cartridge	E,H	339.73	300.88						
					Panel	A,B,C,D,F,G	281.88	281.88						
					Cartridge	E,H	300.88	300.88						



## Dimensional Data

Table 49. Unit Dimensions (continued)

Tons	Refrigeration System Performance		Unit Function		Relief Option		Outside Air		Pre-Evaporator Coil Filter		Overall Length (in.)	Foot-print Length (in.)	H (in)	W (in)
	Type	Digit 9	Type	Digit 2	Type	Digit 18	Type	Digit 27	Type	Digit 24				
70	Standard	1	No Heat	A	Relief Fan	2	Yes	1,2,3,4	Panel	A,B,C,D,F,G	268.50	266.15	81.59	116.13
					Cartridge	E,H	287.50	285.15						
					Panel	A,B,C,D,F,G	268.50	229.66						
					Cartridge	E,H	287.50	248.66						
					Panel	A,B,C,D,F,G	229.66	229.66						
					Cartridge	E,H	248.66	248.66						
		Electric Heat, Gas Heat, No Heat - Extended Casing	EFX	Relief Fan	2	Yes	1,2,3,4	Panel	A,B,C,D,F,G	320.73	318.37			
				Cartridge	E,H	339.73	337.37							
				Panel	A,B,C,D,F,G	320.73	281.88							
				Cartridge	E,H	339.73	300.88							
				Panel	A,B,C,D,F,G	281.88	281.88							
				Cartridge	E,H	300.88	300.88							
	High Efficiency	2	No Heat	A	Relief Fan	2	Yes	1,2,3,4	Panel	A,B,C,D,F,G	316.50	314.15		
					Cartridge	E,H	347.50	345.15						
					Panel	A,B,C,D,F,G	316.50	277.65						
					Cartridge	E,H	347.50	308.65						
					Panel	A,B,C,D,F,G	277.65	277.65						
					Cartridge	E,H	308.65	308.65						
		Electric Heat, Gas Heat, No Heat - Extended Casing	EFX	Relief Fan	2	Yes	1,2,3,4	Panel	A,B,C,D,F,G	368.70	366.35			
				Cartridge	E,H	399.70	397.35							
				Panel	A,B,C,D,F,G	368.70	329.86							
				Cartridge	E,H	399.70	360.86							
				Panel	A,B,C,D,F,G	329.86	329.86							
				Cartridge	E,H	360.86	360.86							
eFlex™	3	No Heat	A	Relief Fan	2	Yes	1,2,3,4	Panel	A,B,C,D,F,G	316.50	314.15			
				Cartridge	E,H	347.50	345.15							
				Panel	A,B,C,D,F,G	316.50	277.65							
				Cartridge	E,H	347.50	308.65							
				Panel	A,B,C,D,F,G	277.65	277.65							
				Cartridge	E,H	308.65	308.65							
	Electric Heat, Gas Heat, No Heat - Extended Casing	EFX	Relief Fan	2	Yes	1,2,3,4	Panel	A,B,C,D,F,G	368.70	366.35				
			Cartridge	E,H	399.70	397.35								
			Panel	A,B,C,D,F,G	368.70	329.86								
			Cartridge	E,H	399.70	360.86								
			Panel	A,B,C,D,F,G	329.86	329.86								
			Cartridge	E,H	360.86	360.86								

**Table 49. Unit Dimensions (continued)**

Tons	Refrigeration System Performance		Unit Function		Relief Option		Outside Air		Pre-Evaporator Coil Filter		Overall Length (in.)	Footprint Length (in.)	H (in)	W (in)		
	Type	Digit 9	Type	Digit 2	Type	Digit 18	Type	Digit 27	Type	Digit 24						
75	Standard	1	No Heat	A	Relief Fan	2	Yes	1,2,3,4	Panel	A,B,C,D,F,G	268.50	266.15	81.59	116.13		
					Cartridge	E,H	287.50	285.15								
					Panel	A,B,C,D,F,G	268.50	229.66								
			Cartridge	E,H	287.50	248.66										
			Panel	A,B,C,D,F,G	229.66	229.66										
			Cartridge	E,H	248.66	248.66										
	Electric Heat, Gas Heat, No Heat - Extended Casing	EFX	Relief Fan	2	Yes	1,2,3,4	Panel	A,B,C,D,F,G	320.73	318.37						
											Cartridge	E,H			339.73	337.37
			Cartridge	E,H	339.73	300.88										
							Panel	A,B,C,D,F,G	281.88	281.88						
											Cartridge	E,H			300.88	300.88
	Relief Fan	2	Yes	1,2,3,4	Panel	A,B,C,D,F,G										
							Cartridge	E,H	347.50	345.15						
											Panel	A,B,C,D,F,G			316.50	277.65
	Cartridge	E,H	347.50	308.65												
					Panel	A,B,C,D,F,G	277.65	277.65								
									Cartridge	E,H	308.65	308.65				
	Relief Fan	2	Yes	1,2,3,4											Panel	A,B,C,D,F,G
					Cartridge	E,H	399.70	397.35								
									Panel	A,B,C,D,F,G	368.70	329.86				
	Cartridge	E,H	399.70	360.86												
					Panel	A,B,C,D,F,G	329.86	329.86								
									Cartridge	E,H	360.86	360.86				
Relief Fan	2	Yes	1,2,3,4	Panel									A,B,C,D,F,G	316.50	314.15	
					Cartridge	E,H	347.50	345.15								
									Panel	A,B,C,D,F,G	316.50	277.65				
Cartridge	E,H	347.50	308.65													
				Panel	A,B,C,D,F,G	277.65	277.65									
								Cartridge	E,H	308.65	308.65					
Relief Fan	2	Yes	1,2,3,4									Panel	A,B,C,D,F,G	368.70	366.35	
				Cartridge	E,H	399.70	397.35									
								Panel	A,B,C,D,F,G	368.70	329.86					
Cartridge	E,H	399.70	360.86													
				Panel	A,B,C,D,F,G	329.86	329.86									
								Cartridge	E,H	360.86	360.86					

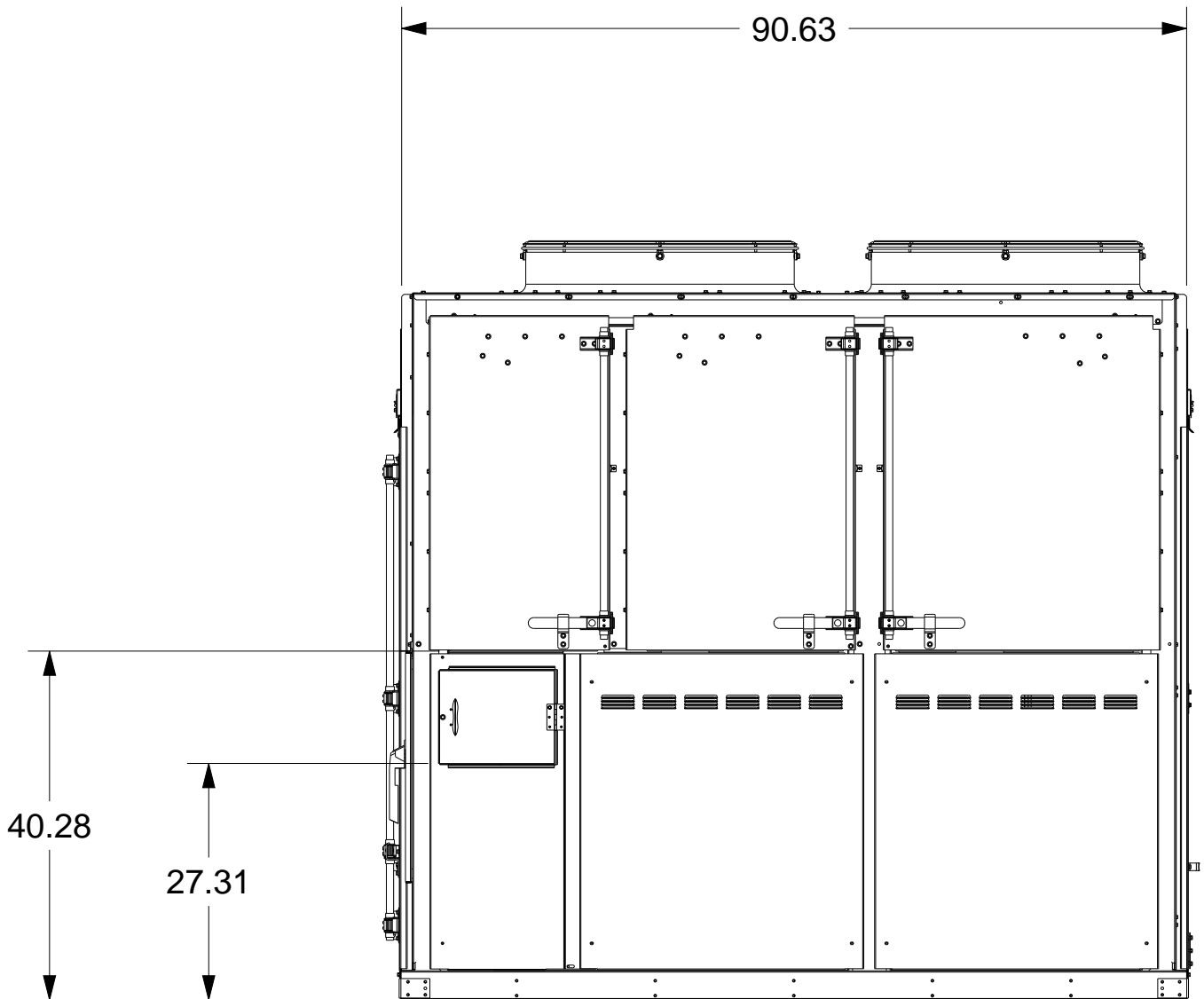
**Notes:**

1. Difference between overall length and footprint length is outside air hood.
2. Refrigeration System Performance impacts length in 70 and 75 ton due to staggered coil configuration

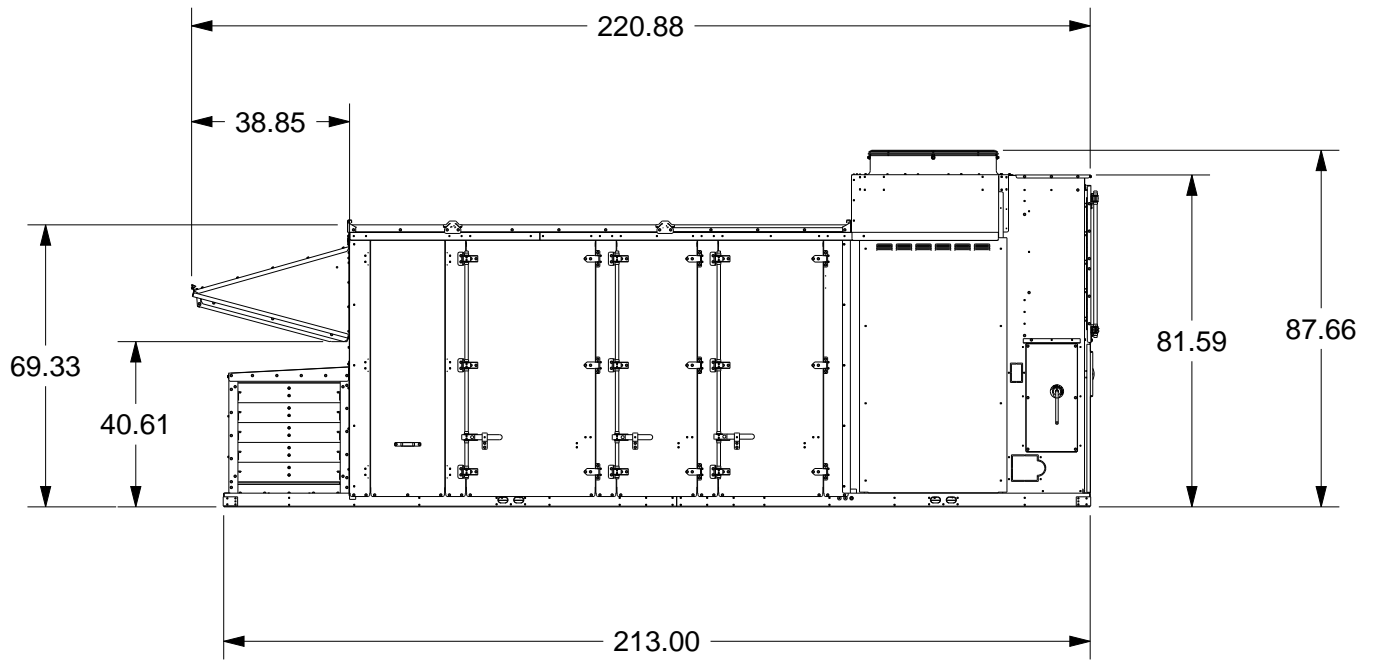


# Dimensional Data

Figure 32. 20 to 30 ton – front view (inches)



FRONT VIEW  
20-30T

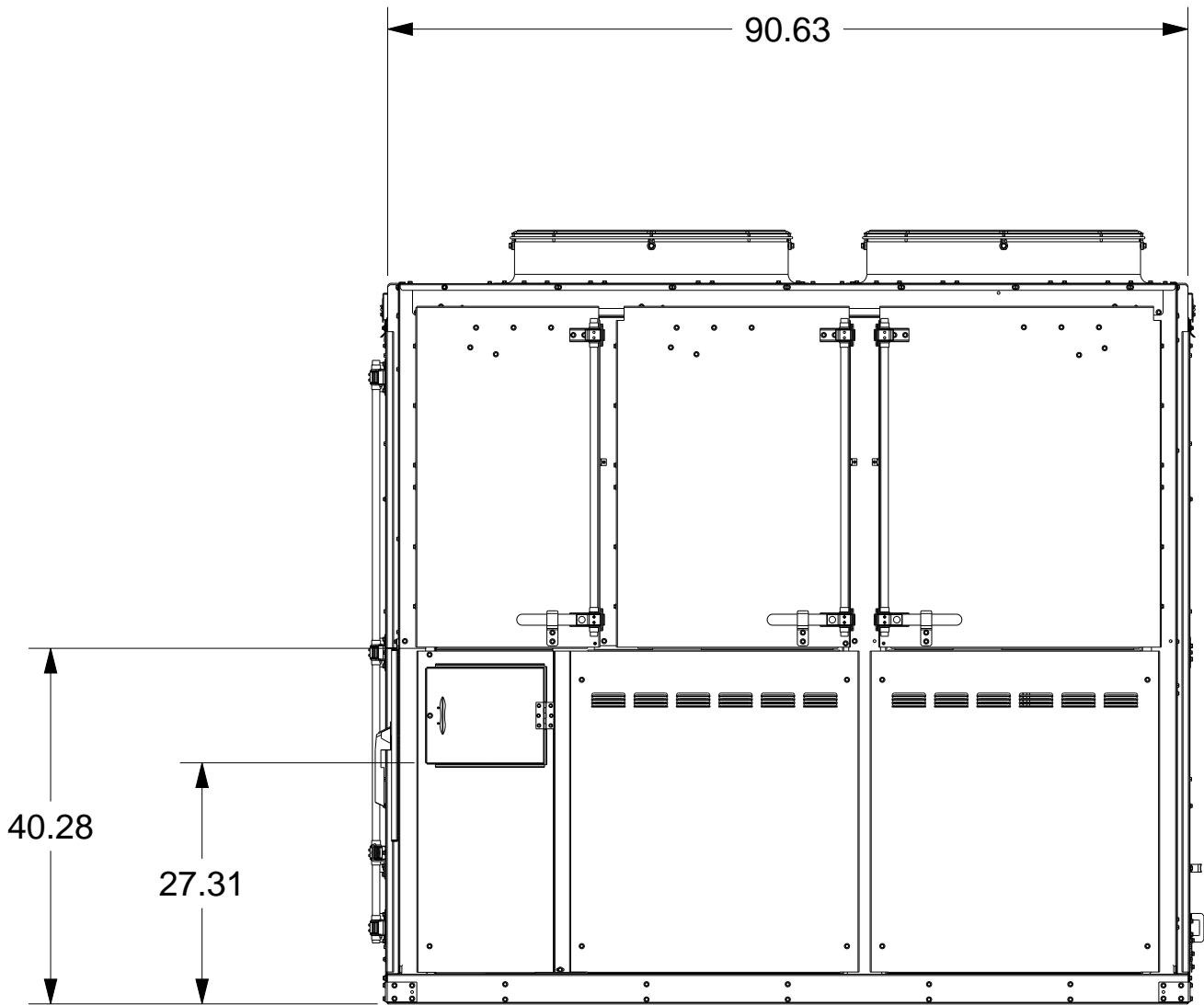
**Figure 33. 20 to 30 ton – left view of sample configuration (inches)**


LEFT SIDE VIEW  
20-30T / NO HEAT / RELIEF FANS / PANEL FILTERS



## Dimensional Data

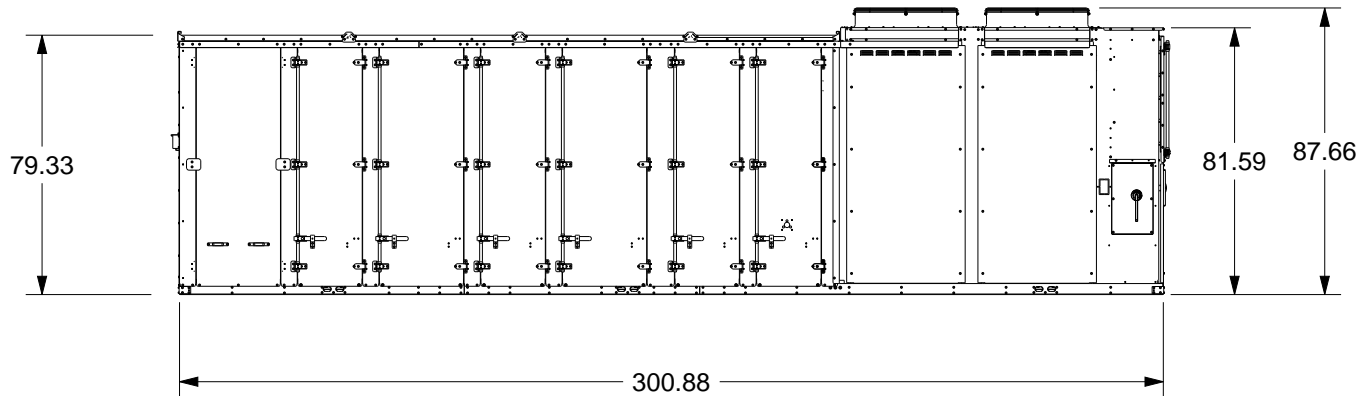
Figure 34. 40 to 55 ton – front view (inches)



FRONT VIEW  
40-55T

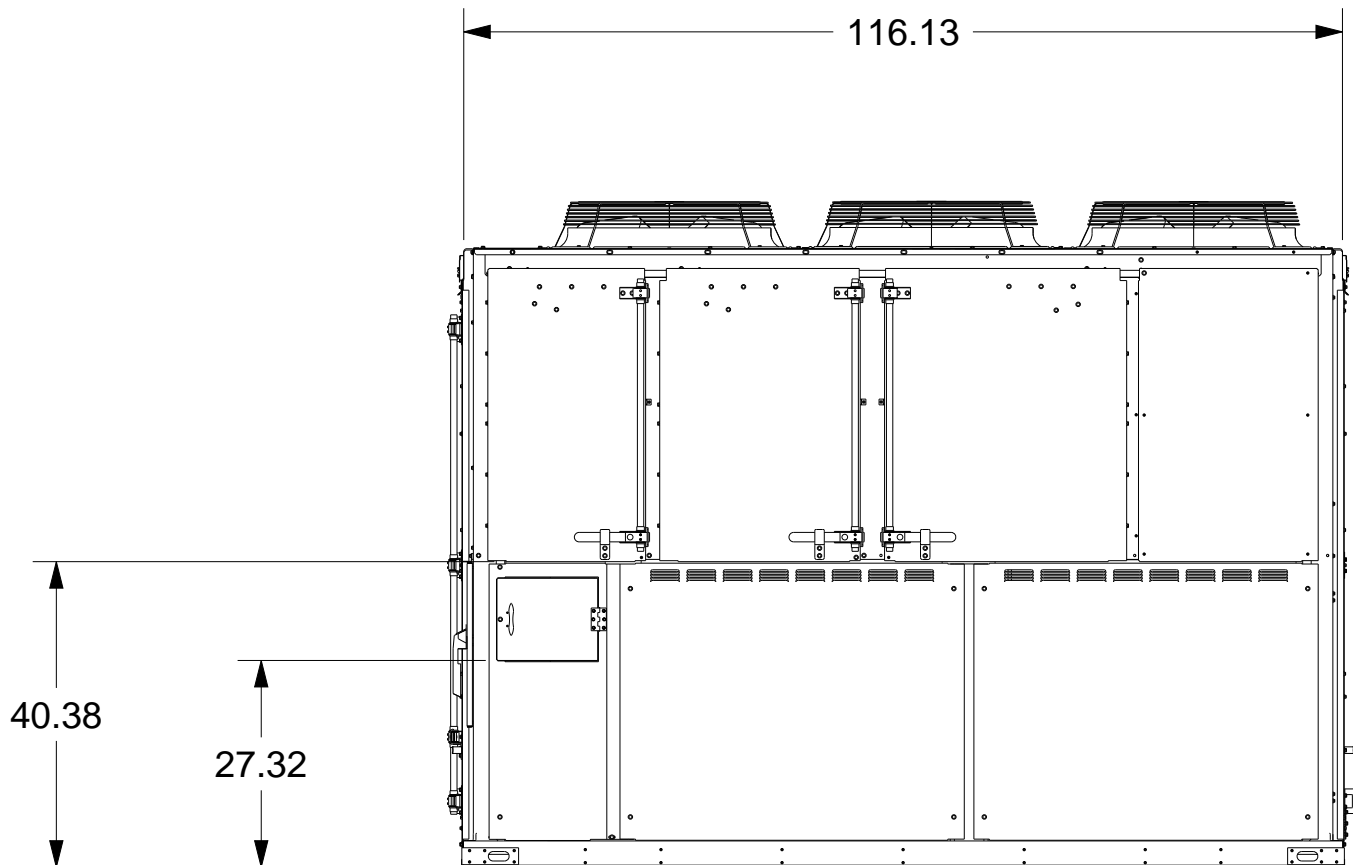


Figure 35. 40 to 55 ton – left view of sample configuration (inches)



LEFT SIDE VIEW  
40-55T / ELECT. HT. / CART. FILTERS

Figure 36. 60 to 75 ton – front view (inches)

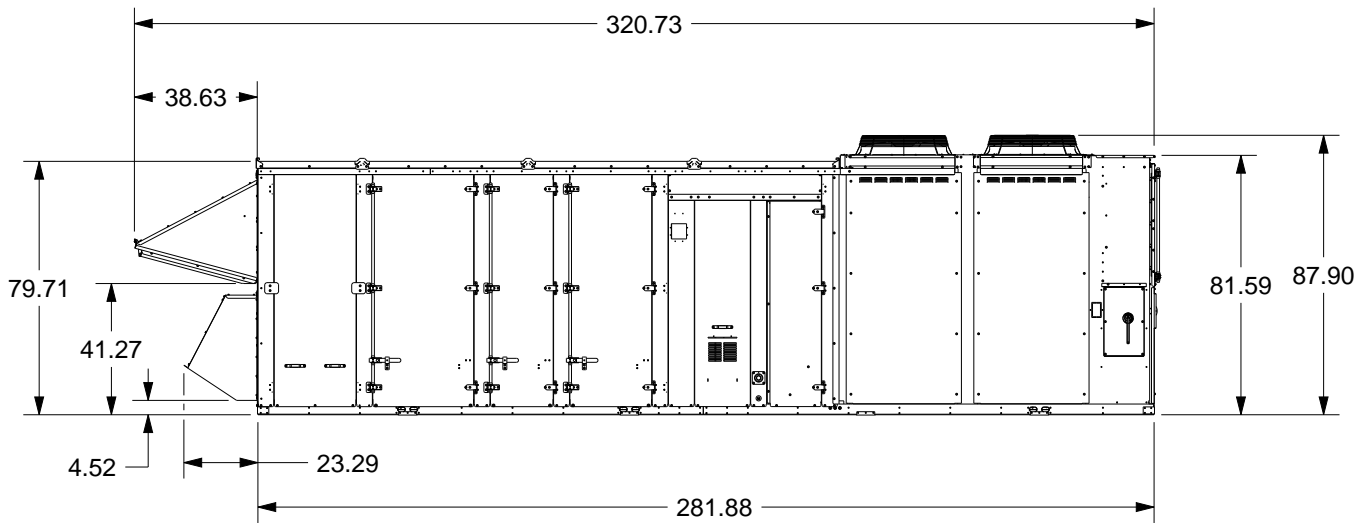


FRONT VIEW  
60-75T



## Dimensional Data

Figure 37. 60 to 75 ton – left view of sample configuration (inches)



LEFT SIDE VIEW  
60-75T / GAS HEAT / BAROMETRIC RELIEF / PANEL FILTERS

# Optional Configurations

**Figure 38. 20 – 30 ton options**


A	B	C	D	E	F	G
Relief Option	Return / Economizer	Filter	DX Coil	Supply Fan	Heat	Condenser / Control Panel
None	Return Opening Only	Panel	Slab	DDP Fan	No Heat	Condenser
0.0"	30.0"	5.0"	24.5"	59.5"	3.5"	59.0"
Outside Air	0-25% Manual	Cartridge			Natural Gas	
39.0"	30.0"	21.0"			53.0"	
Barometric Relief	Economizer				Electric	
39.0"	30.0"				53.0"	
Relief Fan					Final Filter/Extended	
39.0"					53.0"	

# Dimensional Data

Figure 39. 40 – 55 ton options



A	B	C	D	E	F	G
Relief Option	Return / Economizer	Filter	DX Coil	Supply Fan	Extended Casing	Condenser / Control Panel
None	Return Opening Only	Panel	Slab	DDP Fan	No Heat	Condenser
0.0"	38.0"	5.0"	24.5"	59.5"	3.5"	99.5"
Outside Air	0-25% Manual	Cartridge			Natural Gas	
39.0"	38.0"	21.0"			55.5"	
Barometric Relief	Economizer				Electric	
39.0"	38.0"				55.5"	
Relief Fan					Final Filter/Extended	
39.0"					55.5"	

**Figure 40. 60 – 75 ton options**


A	B	C	D	E	F	G
Relief Option	Return / Economizer	Filter	DX Coil	Supply Fan	Extended Casing	Condenser / Control Panel
None	Return Opening Only	Panel	Slab	DDP Fan	No Heat	Condenser
0.0"	38.0"	5.0"	24.5"	59.5"	3.5"	99.5"
Outside Air	0-25% Manual	Cartridge*	Staggered		Natural Gas	
39.0"	38.0"	21.0"	72.5"		55.5"	
Barometric Relief	Economizer	Cartridge*			Electric	
39.0"	38.0"	36.0"			55.5"	
Relief Fan	Economizer				Final Filter/Extended	
39.0"	38.0"				55.5"	

# Roof Curb

Figure 41. Service clearance

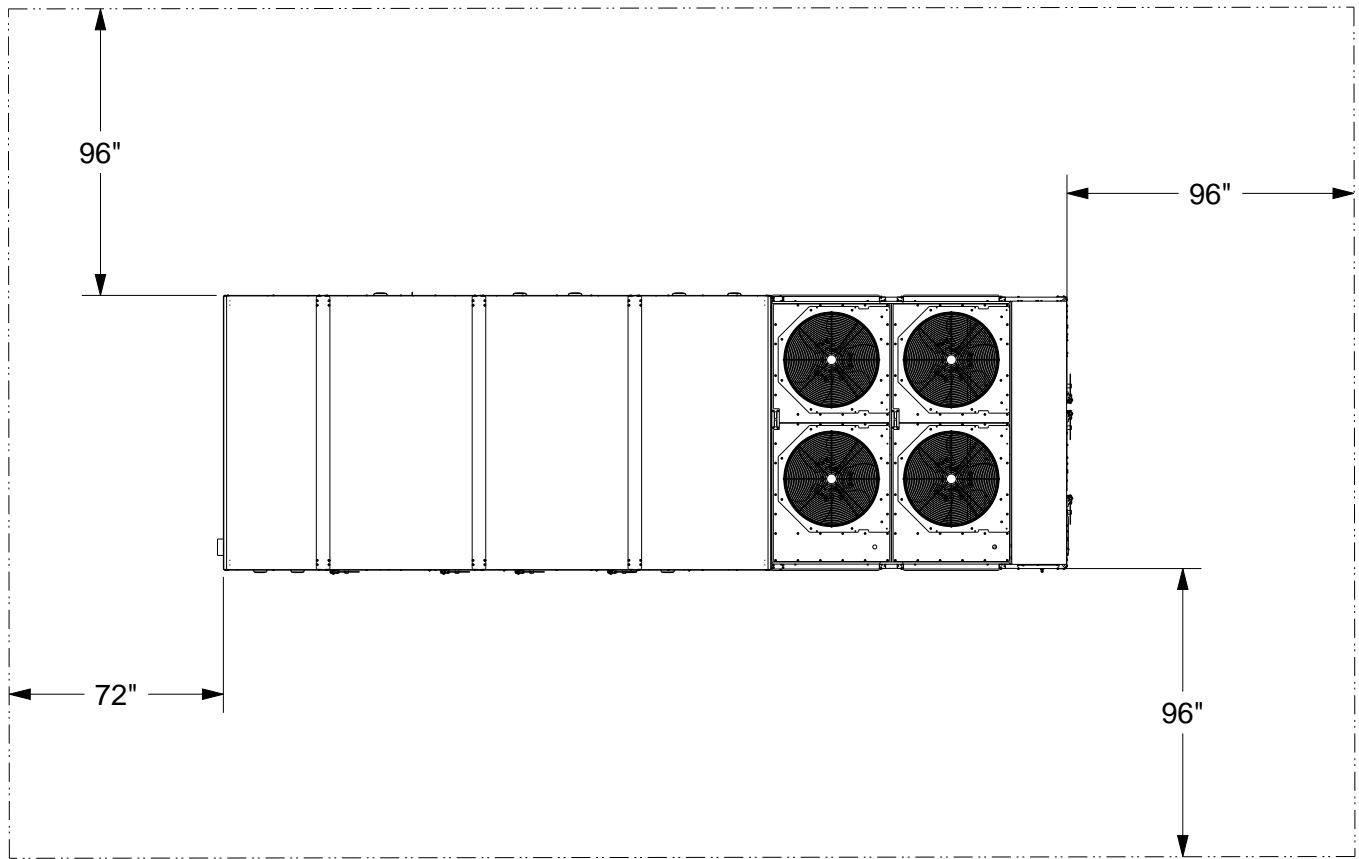
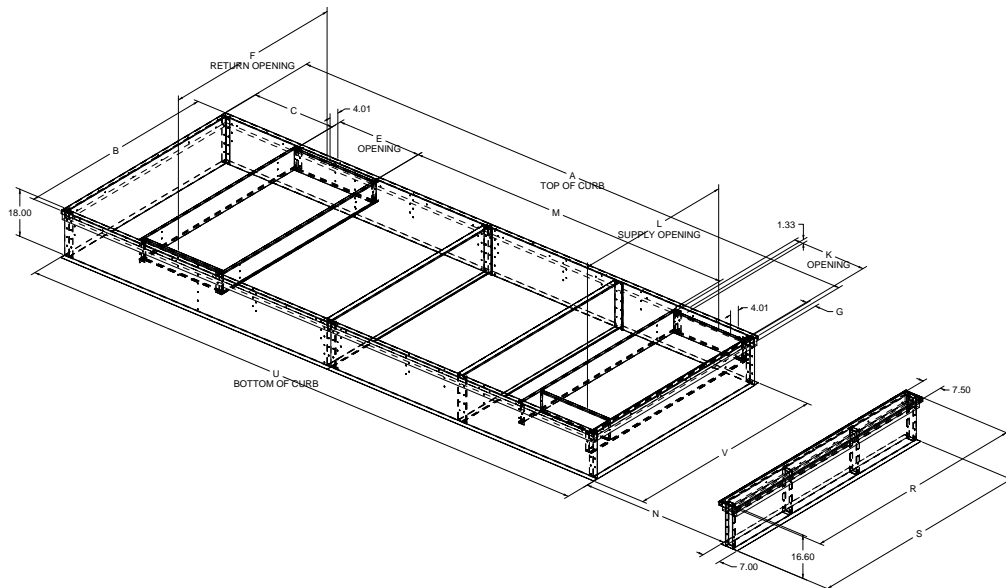


Figure 42. Roof curb dimensions (inches)

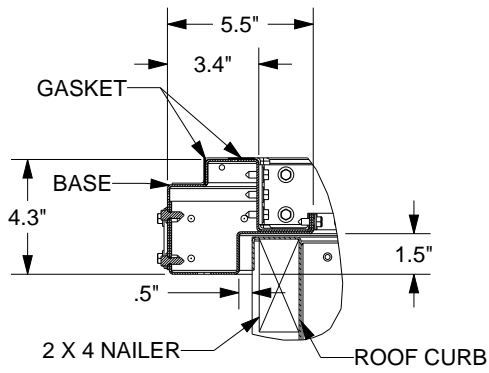


**Table 50. Roof curb dimensional data (inches)**

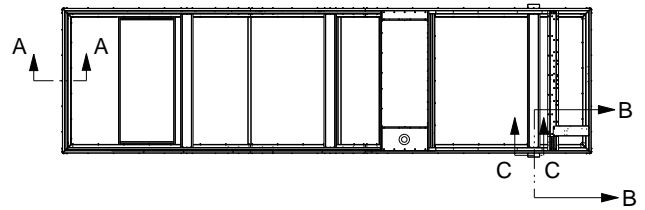
Description	A	B	C	E	F	G	K	L	M	N	R	S	U	V
RX, 20-30 T, PANEL FILTER, RELFAN	200.97	84.50	33.05	26.13	76.49	3.60	27.00	67.50	111.19	18.97	95.94	94.50	201.29	84.82
RX, 20-30 T, CART FILTER	188.99	84.50	3.58	24.62	76.49	3.60	27.00	67.50	130.19	18.97	95.94	94.50	189.31	84.82
RX, 20-30 T, CART FILTER, RELFAN	219.97	84.50	33.05	26.13	76.49	3.60	27.00	67.50	130.19	18.97	95.94	94.50	220.29	84.82
RA, 20-30 T, PANEL FILTER	120.26	84.50	3.58	24.62	76.49	23.85	28.50	76.49	39.72	18.97	95.94	94.50	120.58	84.82
RA, 20-30 T, PANEL FILTER, RELFAN	151.25	84.50	33.05	26.13	76.49	23.85	28.50	76.49	39.72	18.97	95.94	94.50	151.57	84.82
RA, 20-30 T, CART FILTER	139.26	84.50	3.58	24.62	76.49	23.85	28.50	76.49	58.72	18.97	95.94	94.50	139.58	84.82
RA, 20-30 T, CART FILTER, RELFAN	170.25	84.50	33.05	26.13	76.49	23.85	28.50	76.49	58.72	18.97	95.94	94.50	170.57	84.82
RX, 40-55 T, PANEL FILTER	179.99	84.50	3.58	32.12	76.49	3.60	29.50	67.50	111.19	59.12	95.94	94.50	180.31	84.82
RX, 40-55 T, PANEL FILTER, RELFAN	210.97	84.50	33.05	33.63	76.49	3.60	29.50	67.50	111.19	59.12	95.94	94.50	211.29	84.82
RX, 40-55 T, CART FILTER	198.99	84.50	3.58	32.12	76.49	3.60	29.50	67.50	130.19	59.12	95.94	94.50	199.31	84.82
RX, 40-55 T, CART FILTER, RELFAN	229.97	84.50	33.05	33.63	76.49	3.60	29.50	67.50	130.19	59.12	95.94	94.50	230.29	84.82
RA, 40-55 T, PANEL FILTER	127.76	84.50	3.58	32.12	76.49	23.85	28.50	76.49	39.72	59.12	95.94	94.50	128.08	84.82
RA, 40-55 T, PANEL FILTER, RELFAN	158.75	84.50	33.05	33.63	76.49	23.85	28.50	76.49	39.72	59.12	95.94	94.50	159.07	84.82
RA, 40-55 T, CART FILTER	146.76	84.50	3.58	32.12	76.49	23.85	28.50	76.49	58.72	59.12	95.94	94.50	147.08	84.82
RA, 40-55 T, CART FILTER, RELFAN	177.75	84.50	33.05	33.63	76.49	23.85	28.50	76.49	58.72	59.12	95.94	94.50	178.07	84.82
RX, 60-75 T, PANEL FILTER	179.99	110.00	3.58	32.12	101.99	3.60	29.50	93.00	111.19	59.12	121.44	120.00	180.31	110.32
RX, 60-75 T, PANEL FILTER, RELFAN	216.48	110.00	38.56	33.63	101.99	3.60	29.50	93.00	111.19	59.12	121.44	120.00	216.80	110.32
RX, 60-75 T, CART FILTER	198.99	110.00	3.58	32.12	101.99	3.60	29.50	93.00	130.19	59.12	121.44	120.00	199.31	110.32
RX, 60-75 T, CART FILTER, RELFAN	235.48	110.00	38.56	33.63	101.99	3.60	29.50	93.00	130.19	59.12	121.44	120.00	235.80	110.32
RA, 60-75 T, PANEL FILTER	127.76	110.00	3.58	32.12	101.99	22.85	29.50	101.99	39.72	59.12	121.44	120.00	128.08	110.32
RA, 60-75 T, PANEL FILTER, RELFAN	164.25	110.00	38.56	33.63	101.99	22.85	29.50	101.99	39.72	59.12	121.44	120.00	164.57	110.32
RA, 60-75 T, CART FILTER	146.76	110.00	3.58	32.12	101.99	22.85	29.50	101.99	58.72	59.12	121.44	120.00	147.08	110.32
RA, 60-75 T, CART FILTER, RELFAN	183.25	110.00	38.56	33.63	101.99	22.85	29.50	101.99	58.72	59.12	121.44	120.00	183.57	110.32
RX, 60-75 T, PANEL FILTER, STGEV	227.99	110.00	3.58	32.12	101.99	3.60	29.50	93.00	159.19	59.12	121.44	120.00	228.31	110.32
RX, 60-75 T, PANEL FILTER, RELFAN, STGEV	264.48	110.00	38.56	33.63	101.99	3.60	29.50	93.00	159.19	59.12	121.44	120.00	264.80	110.32
RX, 60-75 T, CART FILTER, STGEV	258.99	110.00	3.58	32.12	101.99	3.60	29.50	93.00	190.19	59.12	121.44	120.00	259.31	110.32
RX, 60-75 T, CART FILTER, RELFAN, STGEV	295.48	110.00	38.56	33.63	101.99	3.60	29.50	93.00	190.19	59.12	121.44	120.00	295.80	110.32
RA, 60-75 T, PANEL FILTER, STGEV	175.76	110.00	3.58	32.12	101.99	22.85	29.50	101.99	87.72	59.12	121.44	120.00	176.08	110.32
RA, 60-75 T, PANEL FILTER, RELFAN, STGEV	212.25	110.00	38.56	33.63	101.99	22.85	29.50	101.99	87.72	59.12	121.44	120.00	212.57	110.32
RA, 60-75 T, CART FILTER, STGEV	206.76	110.00	3.58	32.12	101.99	22.85	29.50	101.99	118.72	59.12	121.44	120.00	207.08	110.32
RA, 60-75 T, CART FILTER, RELFAN, STGEV	243.25	110.00	38.56	33.63	101.99	22.85	29.50	101.99	118.72	59.12	121.44	120.00	243.57	110.32

**Note:** High efficiency and eFlex™ refrigeration system performance for both 70 and 75 tons have a staggered evaporator coil (STGEV).

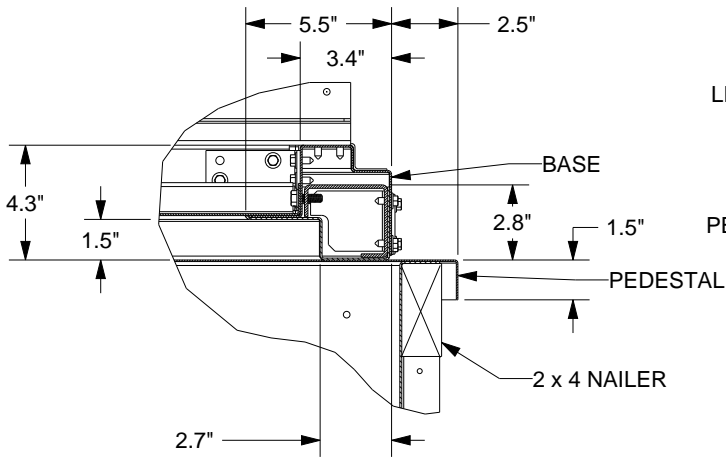
**Figure 43. Base and pedestal**



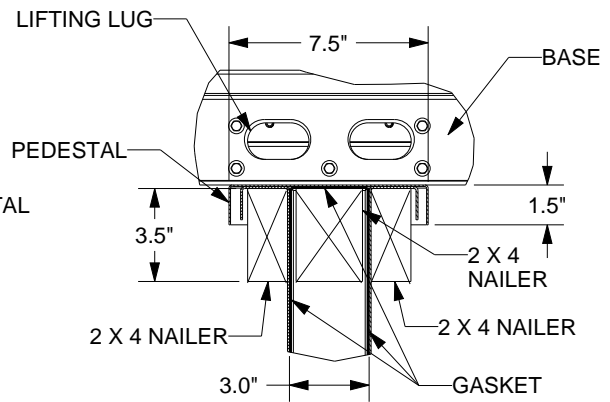
TYPICAL ROOF CURB & BASE DETAIL  
SECT. A-A



PLAN VIEW



TYPICAL PEDESTAL & BASE DETAIL  
SECT. B-B  
(SIDE VIEW OF PEDESTAL)

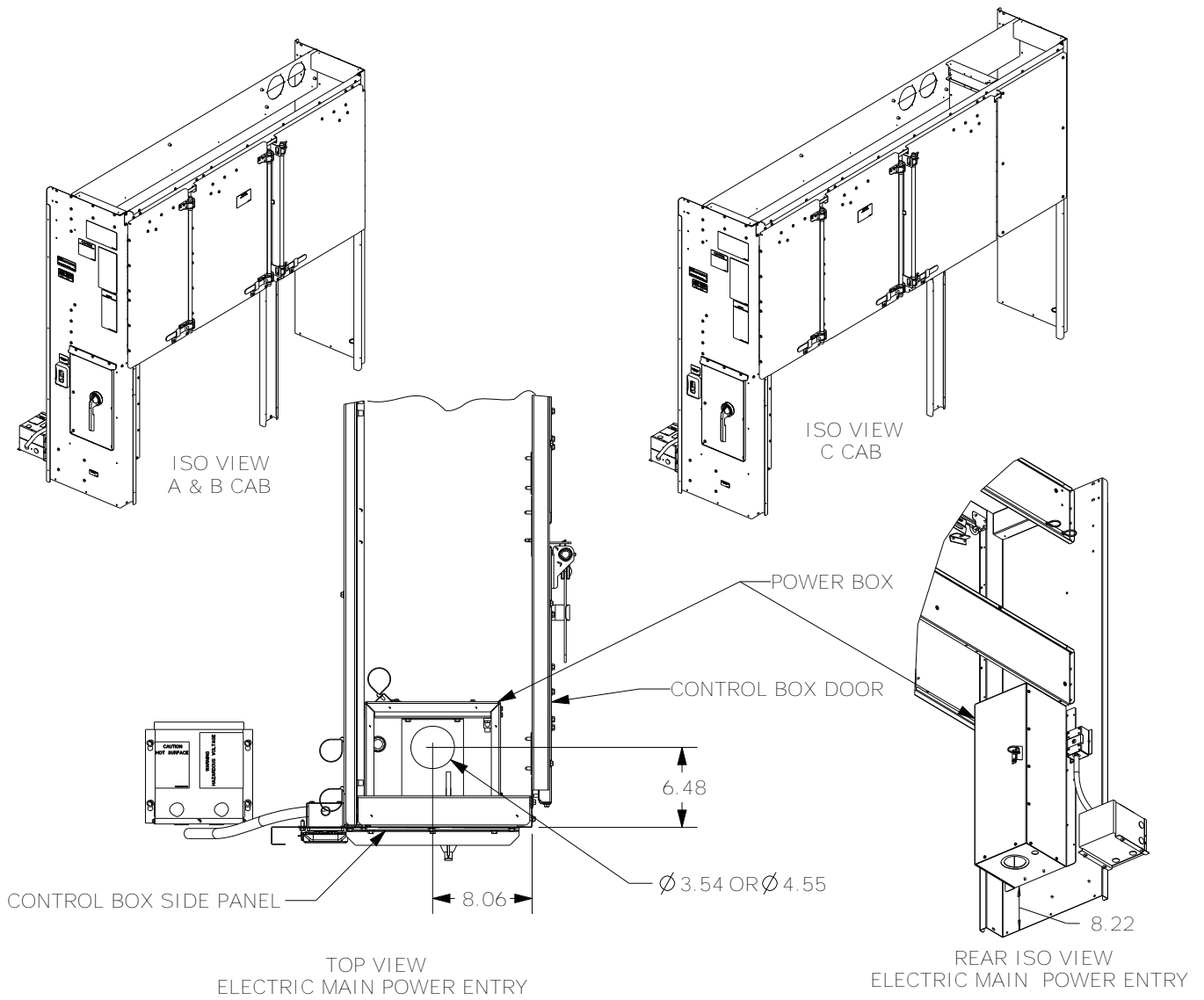


TYPICAL PEDESTAL & BASE DETAIL  
SECT. C-C  
(END VIEW OF PEDESTAL)



# Electrical Entry Details

Figure 44. Electrical connections (inches)



## Access Clearances

Figure 45. Minimum access clearances – 20 to 30 ton

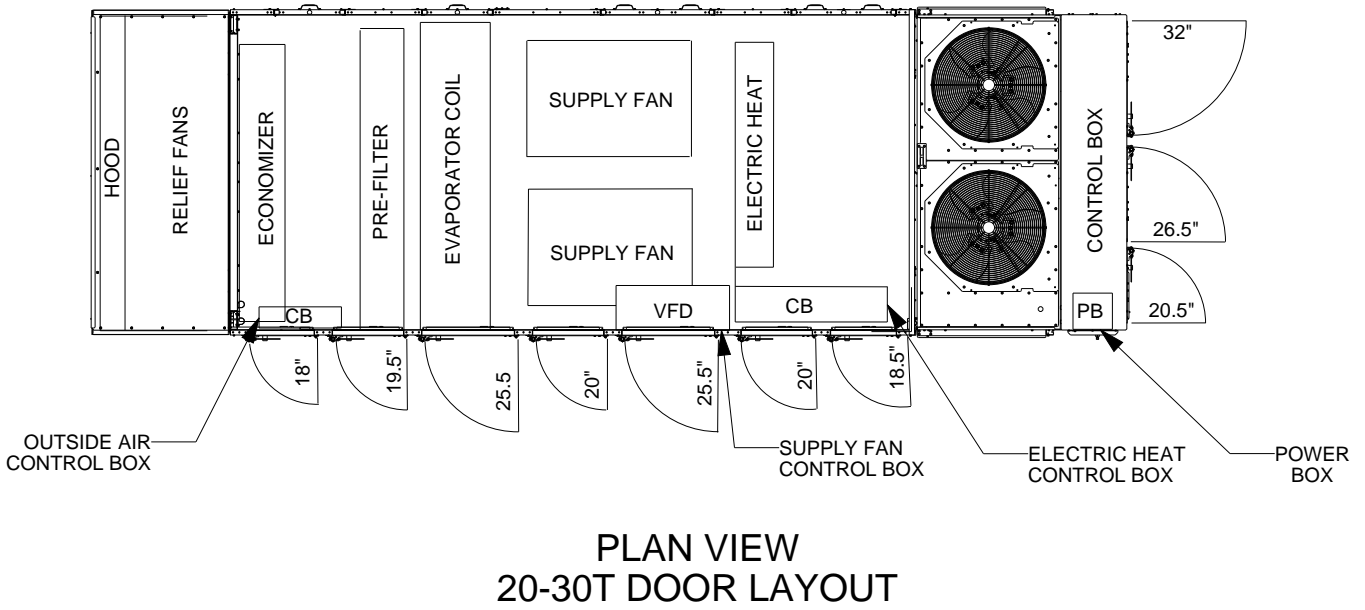


Figure 46. Minimum access clearances – 40 to 55 ton

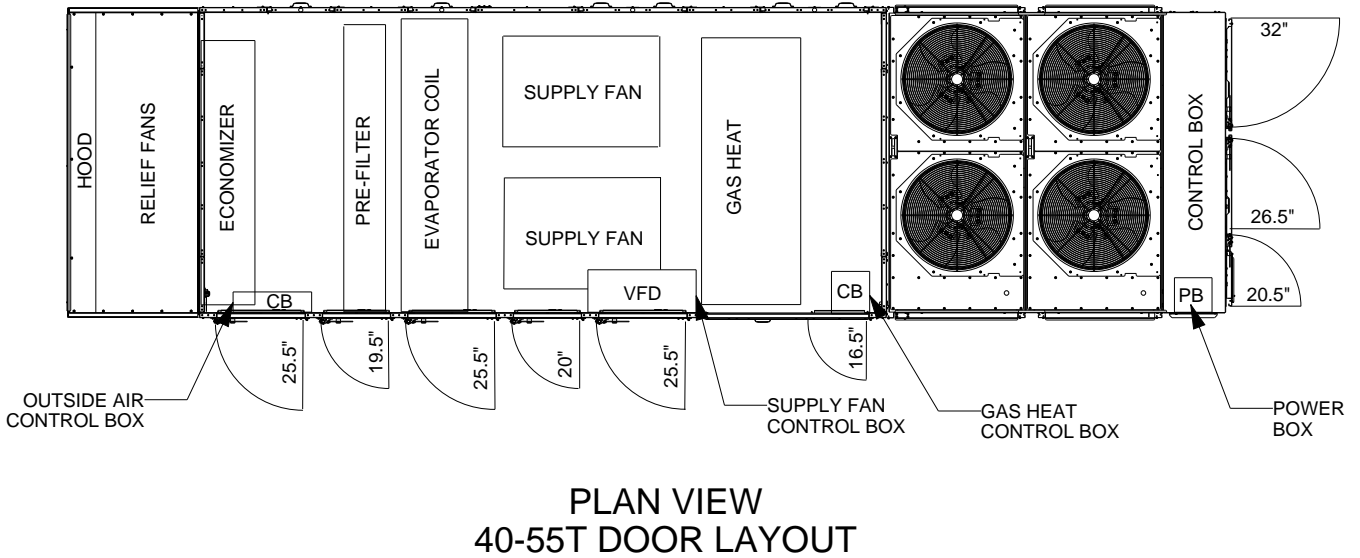
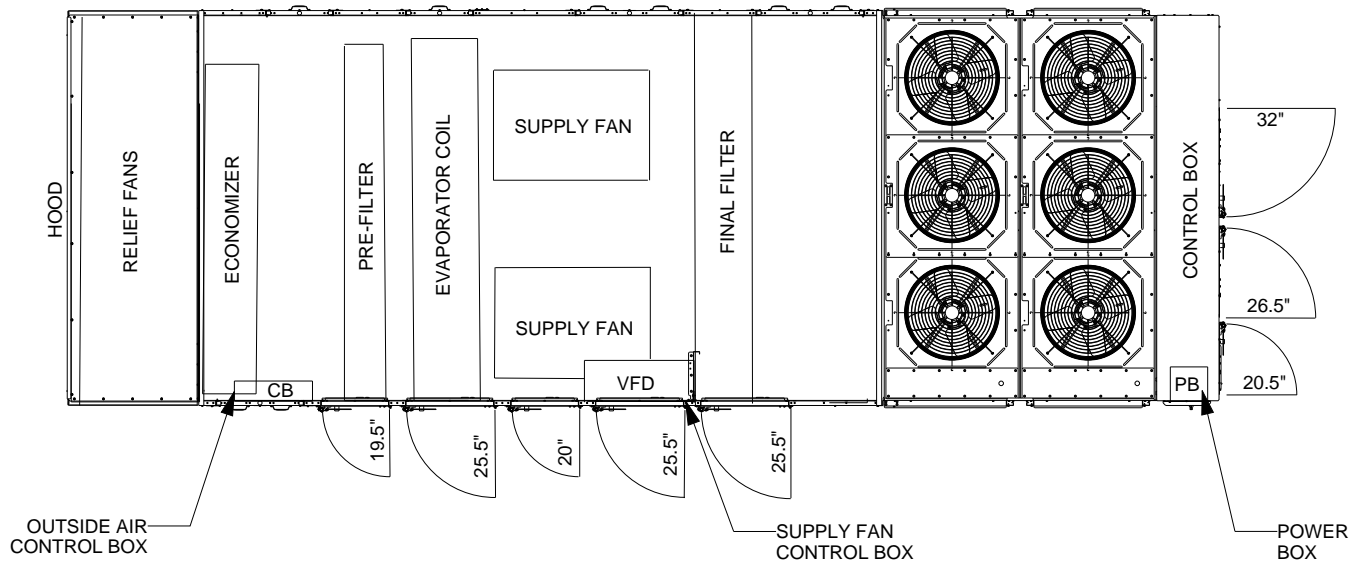


Figure 47. Minimum access clearances – 60 to 75 ton



PLAN VIEW  
60-75T DOOR LAYOUT



# Mechanical Specifications

## General

Units shall be specifically designed for outdoor rooftop installation on a roof curb and be completely factory assembled and tested, piped, internally wired, fully charged with R-410A compressor oil, factory run tested and shipped in one piece. Units shall be available for direct expansion cooling only, or direct expansion cooling with natural gas or electric. Filters, outside air system, relief air system, optional non-fused disconnect switches and all operating and safety controls shall be furnished factory installed.

All units shall be UL listed to US and Canadian Safety Standards. Cooling capacity shall be rated in accordance with AHRI Standard 340/360. All units shall have decals and tags to aid in service and indicate caution areas. Electrical diagrams shall be printed on long life water resistant material and shall ship attached to control panel doors.

## Cabinet

### Casing

Exterior panels shall be zinc coated galvanized steel painted with a slate gray baked enamel finish durable enough to withstand a minimum of 672 hours consecutive salt spray application in accordance with standard ASTM B117. Screws shall be magnigard coated.

Refrigeration components and compressor shall be accessible through removable louvered panels as standard.

Unit air handling section shall have a pitched roof and laminated double-wall construction with polyurethane foam core injected between sheet metal panels. Insulation value shall be R9. All interior surfaces shall be suitable for cleaning per ASHRAE 62. All access doors and panels shall have closed cell gaskets. All door, roof and base panels shall have a thermal break.

Unit base shall be watertight with heavy gauge formed load-bearing members and curb overhang. Unit lifting lugs shall accept chains or cables for rigging. Lifting lugs shall also serve as unit tie down points.

### Access Doors

Access doors shall be hinged with a single, exterior mounted, height and tension adjustable handle to provide positive latching at three points. Access doors shall provide a door stop mechanism to latch the door in the open position to prevent unsafe door closure by wind. Serviceable compartments in the air handler such as filters, evaporator coil, supply fan and variable frequency drives shall have doors of laminated, double-wall construction. This construction shall use a polyurethane foam core between the exterior sheet metal pane and the interior line, with an insulating value of R9. Three single wall doors shall be provided for access to the control panel.

## Heating

### Electric Heating

All electric heat models shall be completely assembled and wired. Electric heat control shall be fully integrated with the unit controls. Heavy duty nickel chromium elements internally wired with a maximum density of 35.5 watts per square inch shall be provided. Heater circuits shall be 45 amps or less, each individually fused. Automatic reset high limit control shall operate through heater .

The 200 and 230 volt electric heating models shall have separate power supply to heating section with an optional factory mounted nonfused disconnect, located in the electric heat control panel.

### Modulating Electric Heat

Modulating electric heat is an orderable option for all electric heat sizes. Modulating electric heat provides improved control over the amount of heat being generated by varying the time the heat

is energized. The cycling of the heating elements adjusts the level of heat output. The heater is capable of fully modulating the capacity from 0 to 100 percent.

## **Gas-Fired Heating**

All gas-fired units shall be completely assembled, wired, and fire tested prior to shipment. Units shall be cULus approved specifically for outdoor applications downstream from refrigerant cooling coils.

All gas heaters shall have 81% steady state efficiency, meeting the 2023 Department of Energy efficiency code. Gas-fired heating system control shall be fully integrated with the unit controls. Gas safety controls shall include electronic flame sensing capability. Combustion air shall be proven prior to ignition and during operation. All gas piping shall be threaded connection with a pipe cap provided. Gas supply connection shall be provided through the side or bottom of unit.

Heat exchangers shall have a tubular design with in-shot burners. Direct spark ignition shall be provided. All tubes shall be dimpled for proper heat transfer. Heating system shall incorporate induced draft fans and include a chimney that exhausts away from the air intake.

Heat exchanger shall be pressure and leak tested.

## **Staged Gas Heat**

Heat exchanger material shall be corrosion-resistant aluminized or stainless steel. Sixty second delay shall be provided between first and second stage gas valve operation on two-stage heaters. Continuous electronic flame supervision shall be provided as standard. Staged gas heat units shall be suitable for use with Natural Gas only.

## **Modulating Gas Heat**

Modulating and ultra-modulating gas heaters shall be made from grades of stainless steel suitable for condensing situations. Burner shall be linkage-less for easy setup and use a variable speed motor for modulation. The modulating heater shall have turn down ratios of 5:1 for 250 MBh & 350 MBh, 10:1 for 500 MBh & 850 MBh, and 21:1 for 1200 MBh. The ultra modulating turn down ratios will have 10:1 for 250 MBh & 350 MBh, 16:1 for 500 MBh, 20:1 for 850 MBh, and 21:1 for 1200 MBh.

## **External Heat**

Controller shall support standard heating operations with customer applied heat sources.

## **Airflow**

### **System Control**

#### **Constant Volume (Zone Temperature)**

Option shall provide all the necessary controls to operate rooftop from a zone sensor, including CV microprocessor unit control module, a microprocessor compressor controller and a unit mounted User Interface Panel. Includes factory installed and tested VFDs to simplify supply fan motor speed adjustment.

#### **Constant Volume (Discharge Air Temperature)**

Option shall provide all the necessary controls to operate a CV rooftop with discharge air temperature control, including discharge air controller and discharge air sensor. The controller shall coordinate the economizer control and the stages of cooling with zone or outdoor air reset capabilities and an adjustable control band to fine-tune the control to specific applications. Includes factory installed and tested VFDs to simplify supply fan motor speed adjustment.

#### **Multi Zone Variable Air Volume (Discharge Air Temperature)**

Option shall provide all necessary controls to operate a VAV rooftop from the discharge air temperature, including discharge air microprocessor controller and discharge air sensor.

The controller shall coordinate the economizer control and the stages of cooling with discharge air temperature reset capabilities. Option shall include factory installed and tested VFDs to provide supply fan motor speed modulation.

### **Single Zone Variable Air Volume (Zone Temperature)**

Single zone VAV option shall provide all necessary controls to operate a rooftop unit based on maintaining two temperature setpoints; the discharge air and zone. Option shall include factory-installed variable frequency drive (VFD) to provide supply fan motor speed modulation. During Single Zone VAV cooling, the unit shall maintain zone cooling setpoint by modulating the supply fan speed more or less to meet zone load demand, and the unit shall maintain discharge temperature to the discharge cooling setpoint by modulating economizer if available and staging DX cooling.

### **Dual Supply Fan - Direct Drive & Variable Speed**

The eDrive™ direct drive plenum supply fan shall be two single width, single inlet 9-blade plenum fans. Fan blades shall be aluminum airfoil. Plenum fans shall be direct-driven. Entire assembly shall be completely isolated from unit and fan board by 2" deflection spring isolation. Multiple fan widths shall be available to optimize efficiency. Beltless fan shall not require routine maintenance such as fan bearing lubrication, belt tensioning and replacement, sheave alignment, and setscrew torque checks.

### **Dual Supply Fan Motor**

Supply fan motors shall be open drip-proof. All supply fans shall be dynamically balanced in factory. Each motor shall have its own Variable Frequency Drive. Supply fan shall be test run in unit and shall reach rated rpm. All 60 Hz supply fan motors shall meet the Energy Independence Security Act of 2007 (EISA).

### **Variable Frequency Drive (VFD) Bypass**

Supply fan bypass control shall provide airflow at 60Hz in the event of drive failure.

## **Relief Option**

### **No Relief**

Relief air opening shall be sealed with panel and made watertight.

### **Barometric Relief**

Gravity dampers shall open to relieve positive pressure in the return air section of the rooftop. Barometric relief dampers shall relieve building overpressurization, when that overpressurization is great enough to overcome the return duct pressure drops.

### **Relief Fan - Direct Drive & Variable Speed**

The eDrive™ relief fan shall be [one] [two] [three] single-width, single-inlet, 5-blade direct-drive plenum fan(s) with backward inclined, high efficiency welded aluminum impeller that is dynamically balanced as an assembly. Fan shall be beltless and maintenance free throughout its operating life. Fans shall be balanced to G6.3 per ISO 21940. No external vibration isolation shall be necessary.

Motor shall be electronically commutated (ECM) and contain power electronics for speed control. Motor modulation shall be managed by the equipment controller. Discharge dampers at unit outlet shall modulate with relief airflow in response to outside air damper position.

### **Relief Fan - Direct Drive & Variable Speed with Statitrac™ Control**

The eDrive™ relief fan shall be [one] [two] [three] single-width, single-inlet, 5-blade direct-drive plenum fan(s) with backward inclined, high efficiency welded aluminum impeller that is dynamically balanced as an assembly. Fan shall be beltless and maintenance free throughout its operating life. Fan shall be balanced to G6.3 per ISO 21940. No external vibration isolation is

necessary. Motor shall be electronically commutated (ECM) and contain power electronics for speed control. Motor modulation shall be managed by the equipment controller.

The modulating relief discharge dampers and ECM shall be modulated in response to building pressure. A differential pressure control system, (Statitrac™), shall use a differential pressure transducer to compare indoor building pressure to outdoor ambient atmospheric pressure. The relief fan shall be turned on when required to lower building static pressure setpoint.

The (Statitrac™) control system shall then modulate the discharge dampers and ECM to control the building pressure to within the adjustable, specified dead band that shall be adjustable at the User Interface.

## **Ventilation Override Mode**

With the ventilation override option installed, the unit shall be programmed to transition to up to 5 different programmed sequences for Smoke Purge, Evacuation, Pressurization, Purge, Purge with duct control sequence and Unit off. The transition shall occur when a binary input on the VOM is closed (shorted); this would typically be a hard wired relay output from a smoke detector or fire control panel.

## **Filters**

### **General**

Filter options shall mount integral within unit and be accessible by hinged access panels.

### **Pre-Evaporator Filter Options (Available for all units)**

#### **MERV 4 Panel Filters**

Panel filters shall be 2-inch thick, MERV 4 disposable fiberglass media, and shall slide into an extruded aluminum rack.

#### **MERV 8 Panel Filters**

Filters shall be [2-inch][4-inch] thick, MERV 8 disposable synthetic media, and shall slide into an extruded aluminum rack.

#### **MERV 14 Panel Filters**

Filters shall be 4-inch thick, MERV 14 microglass media attached to 24 ga aluminized steel frame, and shall slide into an extruded aluminum rack.

#### **MERV 14 Cartridge Filters**

Cartridge filters shall be 12-inch thick, MERV 14 microglass paper media attached to 24 ga galvanized steel frame, and shall slide into a galvanized steel rack. Option shall also include 2-inch thick, MERV 8 panel pre-filters of disposable synthetic media to provide extended cartridge life.

#### **Filter Rack Only**

Option shall provide an extruded aluminum rack (less filter media) with [2-inch][4-inch] nominal thickness filter channels to accommodate applications which require field supplied panel filters.

#### **Cartridge Filter Rack Only**

Option shall provide a galvanized steel rack (less filter media) with 2-inch nominal thickness and 12-inch nominal thickness filter channels to accommodate applications which require field supplied cartridge filters with panel pre-filters.

### **Final Filter Options (Available for RX Units only)**

Final filter options shall mount integral within the blank section unit casing and be accessible by hinged access doors.

#### **MERV 14 Cartridge Filters, Final Filter**

Cartridge final filters shall be 12-inch thick, MERV 14 microglass paper media attached to 24 ga galvanized steel frame, and shall slide into a galvanized steel rack. Option shall also include 2-



## Mechanical Specifications

---

inch thick, MERV 8 panel pre-filters of disposable synthetic media to provide extended cartridge life.

### **Cartridge Filter Rack Only, Final Filter**

Option shall provide a galvanized steel rack (less filter media) in the final filter position with 2-inch nominal thickness and 12-inch nominal thickness filter channels to accommodate applications which require field supplied final cartridge filters with panel pre-filters.

### **Filter Monitoring - Differential Pressure Transducer**

A factory-installed, differential pressure transducer shall be piped to both sides of the [pre evaporator filter] [final filter] to indicate status. Transducer shall maintain a +/- 5 percent accuracy within operating temperature limits of -20°F to 120°F. Transducer shall be mounted in a unit control box and report status through unit control display.

## Outside Air

### **0-25% Manual Damper**

Manually controlled outside air damper shall provide up to 25 percent outside air. Manual outside air damper shall be set at desired position at unit start-up.

### **0-100% Modulating Economizer**

Economizer option shall be operated through the primary temperature controls to automatically utilize outside air for "free" cooling. Automatically modulated return and outside air dampers shall maintain proper temperature in the conditioned space. Economizer shall be equipped with an automatic lockout when the outdoor high ambient temperature is too high for proper cooling.

Minimum position control shall be standard and adjustable at the user interface or with a remote potentiometer or through the building management system. A spring return motor shall ensure closure of OA dampers during unit shutdown or power interruption.

### **Demand Control Ventilation**

When equipped with a CO<sub>2</sub> sensor, the outside air damper position shall modulate in response to a CO<sub>2</sub> sensor in the conditioned space, in order to minimize the unit energy consumption and simultaneously meet the ventilation requirements of ASHRAE Std 62.1. If ordered, the Traq™ airflow monitoring solution shall augment the system, allowing for measurement and control of outside airflow.

### **Outside Air Measurement (Traq™)**

A factory mounted airflow measurement station (Traq™) shall be provided in the outside air opening to measure airflow. The airflow measurement station shall measure from 40 CFM/ton to maximum airflow. The airflow measurement station shall adjust for temperature variations. Measurement accuracy does not exceed 10% at minimum airflow and decreases to less than 5% at higher airflows, meeting requirements of LEED IE Q Credit 1 as defined by ASHRAE 62.1-2007.

### **Economizer Control with Dry Bulb**

An outdoor temperature sensor shall be included for comparing the outdoor dry bulb temperature to a locally adjustable temperature setpoint. The setpoint shall be programmed at the human interface, or remote human interface, to determine if outdoor air temperature is suitable for economizer operation.

### **Economizer Control with Reference Enthalpy**

An outdoor enthalpy sensor shall be provided to compare the total heat content of outdoor air to a locally adjustable setpoint. The setpoint shall be programmed at the user interface to determine if the outdoor enthalpy condition is suitable for economizer operation.

### **Economizer Control with Comparative Enthalpy**

Two enthalpy sensors shall be provided to compare total heat content of the indoor air and outdoor air to determine the most efficient air source when economizing.



### **Low-Leak Economizer Damper**

Low leak dampers shall be provided with rolled stainless steel jamb seals to the sides of the damper assembly. Low leak economizer dampers shall have a leakage rate of 10 CFM/sq ft or less tested in accordance with AMCA Standard 500.

Fault Detection and Diagnostic (FDD) control shall also be provided with Low Leak Economizers. FDD control shall monitor the commanded position of the economizer compared to the feedback position of the damper. If the damper position is outside +/- 10% of the commanded position, a diagnostic shall be generated.

The economizer shall have a functional life of 60,000 opening and closing cycles, thus meeting the requirements of California Title 24. IntelliPak® units ordered 0-100% economizer and dry bulb control shall be listed on the California Energy Commission Registry for factory compliance with Title 24 Economizer and FDD requirements. A label shall be applied to the unit identifying construction with the ultra low leak economizer and FDD controls.

### **Ultra Low-Leak Economizer Damper**

Economizer return and outside air dampers shall be provided with chlorinated polyvinyl chloride gasketing added to the damper blades and rolled stainless steel jamb seals to the sides of the damper assembly. The economizer shall have a functional life of 60,000 opening and closing cycles, thus meeting the requirements of California Title 24. Dampers shall have a maximum leakage rate of 4 CFM/sq-ft at 1.0 inch wg. pressure differential thus meeting requirements of ASHRAE 90.1-2013 and IECC-2012.

Fault Detection and Diagnostic (FDD) control shall also be provided with ultra low leak economizers. FDD control shall monitor the commanded position of the economizer compared to the feedback position of the damper. If the damper position is outside +/- 10% of the commanded position, a diagnostic shall be generated.

IntelliPak® units ordered with 0-100% economizer with dry bulb control shall be listed on the California Energy Commission Registry for factory compliance with Title 24 Economizer and FDD requirements. A label shall be applied to the unit identifying construction with the ultra low leak economizer and FDD controls.

## **Refrigeration System**

### **Fixed Speed Compressors**

Fixed speed compressors shall be industrial grade, energy efficient direct drive 3600 RPM speed scroll type with suction gas-cooled hermetic motor design. Compressor shall have a centrifugal oil pump with dirt separator, and oil charging valve. Each compressor shall have a crankcase heater installed and properly sized to minimize the amount of liquid refrigerant present in the oil sump during off cycles.

Compressor shall be provided with motor winding temperature control to protect against excessive motor temperatures resulting from over-/under-voltage or loss of charge, high and low pressure protection.

### **eFlex™ Variable Speed Compressors**

Trane® eFlex™ variable speed compressors shall be capable of speed modulation from 25 Hz to a maximum of 100 Hz. The minimum unit capacity shall be 15% of full load or less. The compressor motor shall be a permanent magnet type. Each compressor shall have a crankcase heater installed, properly sized to minimize the amount of liquid refrigerant present in the oil sump during off cycles. Compressors shall be equipped with a bearing oil injection system that optimizes bearing and scroll set lubrication, sealing, and controls the oil circulation rate. Optimal bearing lubrication shall be provided by a gear oil pump.

Each variable speed compressor shall be matched with a specially designed variable frequency drive which modulates the speed of the compressor motor and provides several compressor protection functions. Control of the variable speed compressor and inverter shall be integrated with the Symbio™ 800 unit controller to ensure optimal equipment reliability and efficiency.



## Mechanical Specifications

---

### High Efficiency Units

Unit shall meet ASHRAE 189.1-2011 and Consortium for Energy Efficiency (CEE) Advanced Tier Commercial Unitary AC and HP Specification for utility rebate requirements.

### Air-Cooled Condenser Coil

Condenser coils shall have all aluminum microchannel coils, enabling all units to meet LEED EA Credit 4 requirements. All coils shall be leak tested at the factory to ensure pressure integrity. The condenser coil shall be pressure tested to 650 psig. Subcooling circuit(s) shall be provided as standard.

### Air-Cooled Condenser Fans & Motors

All condenser fans shall be vertical discharge, direct drive fans, statically balanced, with aluminum blades and zinc plated steel hubs. Condenser fan motors shall be three-phase motors with permanently lubricated ball bearings, built-in current and thermal overload protection and weather-tight slingers over motor bearings.

### Ambient Control

Low ambient variable speed condenser fan control shall be provided to allow the unit to start down to 0°F and operate down to -10°F.

### Corrosion Protected Condenser Coil

Optional protection on the all aluminum, micro-channel condenser coil shall consist of a corrosion resistant coating that shall withstand ASTM B117 Salt Spray test for 6,000 hours and ASTM G85 A2 Cyclic Acidified Salt Fog test for 2,400 hours. This coating shall be added after coil construction covering all tubes, headers and fin edges, therefore providing optimum protection in more corrosive environments.

### Evaporator Coil

Evaporator coil shall have internally enhanced copper tubing of 3/8 or 1/2-inch O.D. mechanically bonded to heavy-duty aluminum fins of configured design. All coils shall be equipped with electronic expansion valves and factory pressure and leak tested.

### Electronic Expansion Valve

Expansion valves shall be electronically controlled by the Symbio™ 800 unit controller. This fully integrates expansion valve control with unit operation to ensure optimal equipment reliability and efficiency. Expansion valves shall be 2500 step valves for precise refrigerant control and shall be driven closed during off cycles to minimize refrigerant migration and protect compressors. Valve position shall be displayed at the user interface to assist field diagnostics.

### Pressure Transducer

Stainless steel pressure transducer shall provide accurate measurement of high and low side refrigeration system pressure over the entire operating range. System pressures and saturation temperatures shall be displayed at the user interface to improve field diagnostics. The transducer is accessible as it shall be located close to the compressor manifold set. Durable weather proof automotive grade electrical connectors shall be used to ensure reliability.

### Modulating Hot Gas Reheat Control

A reheat condenser coil shall be factory installed downstream of the unit evaporator coil. Modulating electronic valves shall control the flow of refrigerant between the indoor reheat and outdoor condensers in response to the unit discharge air temperature in order to dehumidify the space. Modulating reheat shall be included in circuit 1.

Modulating reheat valves shall be electronically controlled by the Symbio™ 800 unit controller. This fully integrates reheat valve control with unit operation to ensure optimal equipment reliability and efficiency. Modulating reheat valves shall be stepper type valves for precise

refrigerant control. Valve position shall be displayed at the user interface to assist field diagnostics.

### **Hot Gas Bypass**

Electronic Hot Gas Bypass valve piping and controls shall all be included on circuit 1 to allow operation at low airflow, avoiding coil frosting and damage to compressor. When suction pressure falls below valve adjustable setpoint, the valve shall modulate hot gas to the inlet of the evaporator. Valves sized to meet ASHRAE 90.1.

Modulating hot gas bypass valves shall be electronically controlled by the Symbio™ 800 unit controller, and shall integrate the hot gas bypass valve control with unit operation. Modulating hot gas bypass valves shall be stepper type valves for precise refrigerant control. Valve position shall be displayed at the user interface to assist field diagnostics.

### **Compressor Isolation (Suction & Standard Discharge Valves)**

Factory installed valves both upstream and downstream of each compressor set shall enable isolation of compressors from the rest of the refrigeration system if service is required.

### **Evaporator Coil Drain Pan**

Drain pan shall be double sloping [galvanized] [stainless] steel and promote runoff of standing water from condensation inside the unit. Drain pipe connection shall be installed through the side of the unit and connector size is 1.25 NPTI.

### **Condensate Overflow Switch**

Condensate overflow switch shall shut the unit down in the event that a clogged condensate drain line prevents proper condensate removal from the unit.

## **Electrical**

Unit shall be completely factory wired with necessary control and contactor pressure lugs or terminal block for power wiring. Units shall provide an internal location for a non-fused disconnect with external handle for safety.

### **Unit Voltage**

Rooftops shall be available with 200, 230, 460, and 575 voltage, 3 phase, 60 Hz power supplies.

### **Unit Interrupt Rating (Short Circuit Current Rating-SCCR)**

A 5,000 Amp rating shall be applied to the unit enclosure using a non-fused circuit breaker for disconnect switch purposes. Fan motors, compressors, and electric heat circuits shall be provided with protective devices that will provide an elevated level of fault protection.

### **Phase Monitor**

Phase monitor shall protect 3-phase equipment from phase loss, phase reversal and phase imbalance. Any fault condition shall produce a Failure Indicator LED and send the unit into an auto stop condition.

### **Non-Fused Disconnect**

An external handle mounted on the control box door shall be provided to disconnect unit power with the control box door closed for safety.

### **Powered Convenience Outlet**

A 15A, 115V Ground Fault Interrupter convenience outlet shall be factory installed. It shall be wired and powered from a factory mounted transformer. Unit-mounted, non-fused disconnect with external handle shall be furnished with factory powered outlet.



### Symbio™ 800 Controller

The Symbio™ 800 controller is an application-specific, programmable controller that is factory installed and designed to control packaged HVAC equipment. A 7" user interface features a touch-sensitive color screen that provides facility managers with at-a-glance operating status, performance monitoring, scheduling changes and operating adjustments. Other advanced features include automated controller backup and optional features such as secure remote connectivity, wireless building communications, mobile device connectivity and custom programming with expandable I/O.

#### BACnet® Communication Protocol

The Symbio™ 800 controller shall support standard BACnet communication protocol through a RS485, two-wire communication link or BACnet/IP.

#### AirFi™ Wireless Communication Interface Module (WCI)

Trane AirFi™ Wireless Communication interface shall provide wireless communication between the Tracer SC+ and Symbio™ 800 controller.

#### Trane LonTalk® Communication Interface Module

The LonTalk module shall provide an interface to a Tracer building automation system or other control system that supports LonTalk and shall be factory installed, allowing for control and monitoring of the unit through a RS485, two-wire communication link. Requires an additional LonTalk® Communication Kit be installed.

#### Modbus Communication Protocol

The Symbio™ 800 controller shall support standard Modbus® RTU communication protocol through an RS485, two-wire communication link.

#### Power Monitor

Factory installed power meter shall measure unit energy usage to 0.2% accuracy (ANSI C12.20) and communicate through the Symbio™ 800 controller enabling viewing through user interface or building automation system.

#### Controls Expansion Hardware

Symbio™ 800 shall have field applied controls capability. Factory installed expansion hardware (XM70) shall have 19 inputs/outputs. Additional expansions may be added in the field.

#### Rapid Restart

Option shall provide immediate start up upon power failure. A backup generator shall be required on site before unit start up. Rapid Restart shall begin immediately after recovery from a power loss and work by restarting the compressors and supply fan quickly to provide full cooling within two to three minutes.

### Accessories

#### Roof Mounting Curb

Roof mounting curb shall be heavy gauge zinc coated steel with nominal two-inch by four-inch nailer setup. Supply/return air opening gasketing shall be provided. Curb shall ship knocked down for easy assembly. Curb shall be manufactured to National Roofing Contractors Association guidelines.

#### Wall Mounted CO<sub>2</sub> Sensor

The CO<sub>2</sub> (Carbon Dioxide) sensor shall have the ability to monitor space occupancy levels within the building by measuring the parts per million of CO<sub>2</sub> in the air. As the CO<sub>2</sub> levels increase, the outside air damper modulates to meet the CO<sub>2</sub> space ventilation requirements.

## Duct Mounted CO<sub>2</sub> Sensor

The CO<sub>2</sub> (Carbon Dioxide) sensor shall have the ability to monitor space occupancy levels within the building by measuring the parts per million of CO<sub>2</sub> in the air. As the CO<sub>2</sub> levels increase, the outside air damper modulates to meet the CO<sub>2</sub> space ventilation requirements.

## Air-Fi™ Wireless Communication

### **Air-Fi™ Wireless Communication Interface (WCI Indoor)**

Factory installed wireless interface shall allow wireless communication to Air-Fi™ wireless sensors, service tools, equipment controls, and building controller.

### **Air-Fi™ Wireless Communication Sensor – WCS-SB (temperature only)**

Wall mounted wireless temperature sensor shall allow wireless communication to Air-Fi Wireless network, communicating space temperature to Symbio™ 800 equipment controller. Controls shall allow up to 6 WCS models to be used per IntelliPak® RTU.

### **Air-Fi™ Wireless Communication Sensor – WCS-SD (temperature with display)**

Wall mounted wireless temperature sensor shall allow wireless communication to Air-Fi Wireless network, communicating space temperature and occupancy status to Symbio™ 800 equipment controller. Digital interface with pushbuttons shall enable Heat, Cool, Auto operation mode settings and two fan mode settings. Dual temperature set points shall allow for automatic control of the zone temperature heating and cooling requirements when in the Automatic Changeover mode. Controls shall allow up to 6 WCS models to be used per IntelliPak® RTU.

### **Air-Fi™ Wireless Communication Sensor - WCS-SO (temperature and occupancy)**

Wall mounted wireless temperature sensor shall allow wireless communication to Air-Fi Wireless network, communicating space temperature and occupancy status to Symbio™ 800 equipment controller. Controls shall allow up to 6 WCS models to be used per IntelliPak® RTU.

### **Air-Fi™ Wireless Communication Sensor - WCS-SCO<sub>2</sub> (temperature, occupancy, and CO<sub>2</sub>)**

Wall mounted wireless temperature sensor shall allow wireless communication to Air-Fi Wireless network, communicating space temperature, occupancy status, and CO<sub>2</sub> level to Symbio™ 800 equipment controller. Controls shall allow up to 6 WCS models to be used per IntelliPak® RTU.

### **Air-Fi™ Wireless Communication Module - WCS-SH (relative humidity module for use with all WCS models)**

2% accuracy relative humidity module shall be field installed in the Wall mounted WCS models for wireless communication of relative humidity level to Symbio™ 800 equipment controller.

## Trane WiFi Adapter

The Trane Wi-Fi adapter kit (equipped with a USB cable) shall enable communication among devices on a Wi-Fi network to facilitate the wireless integration of client devices such as touch-screen displays and technician laptops as an access point.

## Zone Sensors

### **Remote Zone Temperature Sensor with Timed Override**

Electronic sensor shall be used in conjunction with a Trane ICS system. The Timed Override button shall allow the system to operate at the occupied setpoints while in an unoccupied status.

### **Remote Zone Temperature Sensor w/ Timed Override & Temperature Setpoint**

Electronic sensor shall be used in conjunction with a Trane ICS system with zone temperature setpoint capability. The timed override button shall allow the system to operate at the occupied setpoints while in an unoccupied status.



## Mechanical Specifications

---

### **Remote Zone Sensor**

Thermistor shall be encased in a decorative wall mountable enclosure. It shall be used in conjunction with a Zone Temperature Sensor when remote sensing is desired. The sensor shall communicate temperature changes within a zone to the unit UCP.

### **Dual Set Point Temperature Sensor**

Electronic sensor shall have Heat, Cool, Auto operation mode settings and two fan mode settings. Dual temperature setpoints shall allow for automatic control of the zone temperature heating and cooling requirements when in the Automatic Changeover mode.

### **Dual Set Point Zone Temperature Sensor with LED Lights**

Electronic sensor shall have Heat, Cool and Auto operation mode settings with two Fan mode settings. Dual temperature setpoints shall allow for automatic control of the zone's heating and cooling requirements when in the Automatic Changeover mode. The sensor shall have Heat, Cool, System On, and Service LED's as standard. Should a system malfunction occur, the appropriate Heat, Cool or Service LED shall function as a system failure indicator.

### **Dual Set Point Display (BAYSENS131A)**

Wall mounted zone sensor, communicating space temperature and occupancy status to Symbio™ 800 equipment controller. Digital interface with push buttons enables Heat, Cool, Auto operation mode settings and two fan mode settings. Dual temperature setpoints allow for automatic control of the zone temperature heating and cooling requirements when in the Automatic Changeover mode.

## **Humidity Sensor**

A wall or duct-mounted humidity sensor shall be used to control activation of the hot gas reheat dehumidification option. The humidity sensor shall be set for humidity levels between 40% and 60% relative humidity

### **Duct-Mounted Humidity Sensor**

Shall monitor the humidity levels in the space for 1) Humidification and/or 2) Modulating Hot Gas Reheat

### **Wall-Mounted Humidity Sensor**

Shall monitor the humidity levels in the space for 1) Humidification and/or 2) Modulating Hot Gas Reheat

## **Temperature Sensor**

Bullet or pencil type sensor shall be used for temperature input such as return air duct temperature

## **LonTalk® Communication Kit**

For future opportunities and upgrade flexibility, this kit shall contain a LonTalk® Communication Interface module for communication with a building automation system.

## **Trane Startup**

A Trane technician shall provide unit startup after the unit is properly installed. The installation shall include:

- Unit and all ship-with items installed
- All utilities and drain pipes connected
- All refrigerant piping reconnected and all refrigerant charge adequately distributed throughout the system
- All ductwork attached to the unit

## Prior to Trane Unit Startup

Prior to Trane startup, the following work should be inspected and verified:

### ***Unit inspection - Cabinet***

Review the overall unit for exterior damage (dents, bends, missing panels, doors working properly, etc). Verify the unit interior is free from debris/obstructions, the panels and doors are secured properly, the unit clearances are adequate to avoid air recirculation, and that the unit drain lines and traps are properly installed.

### ***Wiring***

Review the unit main power to ensure that the unit is properly grounded, the main power feed wire gauge is adequately sized, the correct voltage is supplied to the unit and electric heaters (if applicable), and the incoming voltage is phase balanced. Verify that all wiring connections are tight, all field installed control wiring is landed on correct terminals, and that all automation and remote controls, along with control wiring for CV and VAV controls, are correctly installed/wired.

### ***Refrigeration system***

Review the refrigeration system to ensure the coil fins are straightened, shipping hardware and plastic covers for compressors have been removed, compressors contain the correct oil level, service valves are in the correct position, and the crankcase heaters have been operational for at least 12 hours prior to Trane startup.

### ***Fans***

Check the unit fans to ensure the condenser fan blade set-screws to the motor shaft are tight, hold down bolts and channels from fan sections have been removed, proper adjustment of fan section spring isolators, proper fan rotation, and proper fan motor amperage.

### ***Economizer***

Check all damper linkages for proper adjustment. Verify proper damper operation and outside air pressure sensors.

### ***Electric Heat***

On units equipped with electric heaters, check to ensure the heating system matches the unit nameplate and verify that the correct voltage is supplied to the heaters.

### ***Gas Heat***

On units equipped with gas heaters, check to ensure that the flue assembly is secure and properly installed, sufficient gas pressure exists at the unit, no leaks exist in gas supply line, the gas heat piping includes a drip leg, and condensate line is run if required.

## Trane Unit Startup

After the unit installation has been fully completed, a Trane technician shall do the following:

- Verify and log supply fan operation, proper compressor operation, and condenser fan operation, as well as correct levels of superheat and subcooling.
- Verify operation of all VAV modes per job requirements, which include: Supply Air Cooling and Heating, Daytime Warmup, Morning Warmup, and Supply Air Tempering.

***Space pressure control*** – Verify that unit is sensing field installed building pressure input.

***Ventilation override*** – Verify that sequences are set up and functional per customer requirement.

***Economizer*** – Adjust outside air or return air travel and verify all sensor inputs.

***Dehumidification*** – Verify that dehumidification mode operates correctly and is set up per job requirements.

***Outside Air Measurement*** – Verify that Demand Flow Ventilation function is correct.

***Gas Heat*** – Startup gas heat per the unit Installation, Operation, Maintenance Manual (IOM) and record CO<sub>2</sub> and O<sub>2</sub> levels.

***All units*** – Verify User Interface programming, including setpoints and sensor sources per customer requirements. Leave the unit in a running state or off per customer requirement. Once



## Mechanical Specifications

---

the IntelliPak® unit startup is complete, provide a startup activities communication and the associated operating log.



## **Certified AHRI Performance**

Packaged Rooftop units cooling, heating capacities and efficiencies shall be rated within the scope of the Air-Conditioning, Heating & Refrigeration Institute (AHRI) Certification Program and display the AHRI Certified® mark as a visual confirmation of conformance to the certification sections of AHRI Standard 340-360 (I-P) and ANSIZ21.47 and 10 CFR Part 431 pertaining to Commercial Warm Air Furnaces. The applications in this catalog specifically excluded from the AHRI certification program are:

- Ventilation modes
- Heat Recovery
- Units larger than nominal 63 tons



Notes

---





The AHRI Certified mark indicates Trane U.S. Inc. participation in the AHRI Certification program. For verification of individual certified products, go to [ahridirectory.org](http://ahridirectory.org).

Trane - by Trane Technologies (NYSE: TT), a global innovator - creates comfortable, energy efficient indoor environments for commercial and residential applications. For more information, please visit [trane.com](http://trane.com) or [tranetechnologies.com](http://tranetechnologies.com).

Trane has a policy of continuous product and product data improvements and reserves the right to change design and specifications without notice. We are committed to using environmentally conscious print practices.